

PRICE LIST











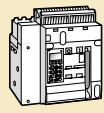
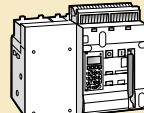
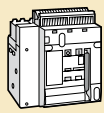

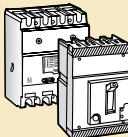

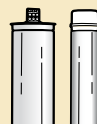

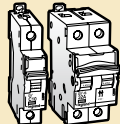
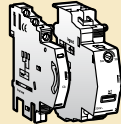
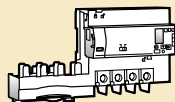

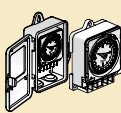



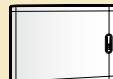

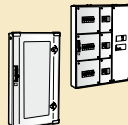

THE **GLOBAL SPECIALIST**
IN ELECTRICAL AND DIGITAL BUILDING INFRASTRUCTURES

FEB
2017

 **legrand**[®]

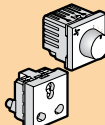
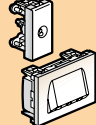
LIVE THE ADVANTAGE

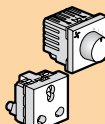
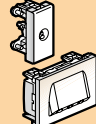
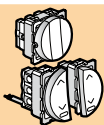
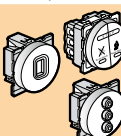
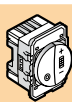
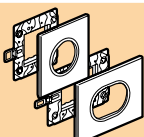
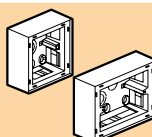
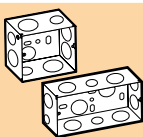
 <p>Power</p>	 <p>P. 07 DMX³ ACB from 630 A to 2500 A Fixed version Draw-out version</p>	 <p>P. 08 DMX³ ACB from 3200 A to 4000 A Fixed version Draw-out version</p>	 <p>P. 08 DMX³ ACB from 5000 to 6300 A Fixed version Draw-out version</p>	
	 <p>P. 12 DRX MCCBs</p>	 <p>P. 13-25 DPX³ MCCBs and Earth leakage modules</p>	 <p>P. 25 Residual current relay and Coils</p>	
	 <p>P. 32-34 <small>NEW!</small> MPX³</p>	 <p>P. 35 Alpican resin filled capacitors Standard duty 440 V Heavy duty 440 V</p>	 <p>P. 35 Alpican gas filled capacitors Heavy duty 440 V</p>	
 <p>Protection, Isolation, Controlling, Signalling, Metering.</p>	 <p>P. 38-42 DX³ MCB Isolator RCDs</p>	 <p>P. 42 DX³ Accessories and Auxillaries</p>	 <p>P. 43 DX³ RCD add-on module with metering</p>	
	 <p>P. 47 Lexic Time delay relay</p>	 <p>P. 47 Time switches and Accessories</p>	 <p>P. 47 Time lag switches</p>	
 <p>Distribution Boards</p>	 <p>P. 52 <small>NEW!</small> Ekinox³ SPN DBs</p>	 <p>P. 52 <small>NEW!</small> Ekinox³ ETPN DBs</p>	 <p>P. 52 <small>NEW!</small> Ekinox³ Flexy DBs</p>	
	 <p>P. 54 <small>NEW!</small> Ekinox³ 7 Segment MCCB DBs</p>	 <p>P. 54 <small>NEW!</small> Ekinox³ Metra Plug & Socket DBs</p>	 <p>P. 54 <small>NEW!</small> Ekinox³ P17 Tempra Plug & Socket DBs</p>	
	 <p>P. 56 SPN, ETPN, 7 Segment & Phase selector DBs</p>	 <p>P. 57 7 segment MCCB, VTPN, DPX³ MCCB, DPX³ 250 ER MCCB & Flexy DBs</p>	 <p>P. 58 Ekinoxe DBs Plexo 3 boxes for DX³</p>	
 <p>Arteor™ Wiring Accessories</p>	 <p>P. 76 Switches, Push buttons and Accessories Square - white mechanisms</p>	 <p>P. 76 Dimmers, Fan regulators and Indian standard sockets and USB Charger</p>	 <p>P. 76-77 Information outlets, TV sockets, Skirting light and Power strip</p>	
	 <p>P. 78-79 Switches, Push buttons and Accessories Square - magnesium mechanisms</p>	 <p>P. 79 Dimmers, Fan regulators and Indian standard sockets and USB Charger</p>	 <p>P. 79 Information outlets, TV sockets, Skirting light and Power strip</p>	
	 <p>P. 81 Switches, Push buttons and Accessories Round - white mechanisms</p>	 <p>P. 81 Information outlets and Hotel DND & MMR and USB Charger</p>	 <p>P. 82 Electronic dimmers, Audio-Video sockets and Micro switches</p>	
	 <p>P. 85-87 Round cover plates</p>	 <p>P. 87 Plastic surface boxes</p>	 <p>P. 87 Metal flush boxes</p>	

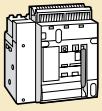

P. 08
DMX³ ACB trip free switches from 1250 A to 6300 A Fixed version Draw-out version



P. 09
Microprocessor based protection unit and Accessories

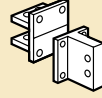

P. 09
DMX³ Rear terminals and Transformation kit

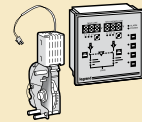

P. 10
DMX³ ACB auxiliaries and Accessories

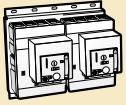

P. 25
DPX³ Automatic transfer switch

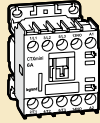

P. 26-28 **NEW!**
CTX³ contactors

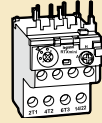

P. 28-30 **NEW!**
RTX³ thermal relays

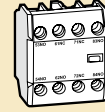

P. 30-31 **NEW!**
CTX³ accessories

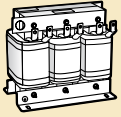

P. 35
Alpican resin filled capacitors for reactors Standard duty 525 V



P. 35
Reactors and power factor controllers



P. 43-44
DX³ Time switches and Contactors

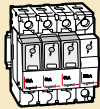

P. 45-46 **NEW!**
SPD

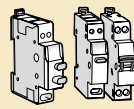

P. 47
DX³ changeover switches, Push buttons and Indicators

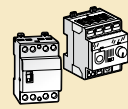

P. 47
Lexic dimmer and Power contactors

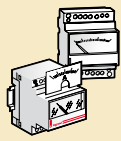

P. 47-48
Lexic ammeters and Current transformers



P. 48
Lexic voltmeters and Selector switches



P. 53 **NEW!**
Ekinox³ VTPN DBs



P. 53 **NEW!**
Ekinox³ VTPN MCCB DBs

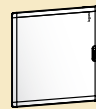

P. 53 **NEW!**
Ekinox³ Phase Selector DBs

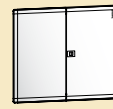

P. 54 **NEW!**
Ekinox³ 7 Segment DBs



P. 55 **NEW!**
Ekinox³ Metal Enclosures



P. 55 **NEW!**
Ekinox³ Cable end box, Meter box, PPT Kit & Accessories



P. 58
Metra Plug & Socket DBs, P17 tempr plug & socket DBs.

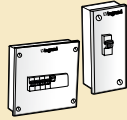

P. 58
Metal one way enclosures, plastic enclosures for DX³

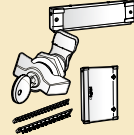

P. 58-59
Cable end box, meter box, PPI Kit & accessories

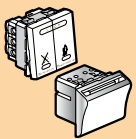

P. 77
Hotel DND & MMR, Keycard and Shaver socket

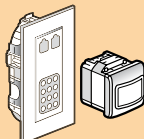

P. 77
Infrared sensors, Clockcon, Keycode and Time switch

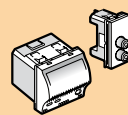

P. 77
Audio-video sockets, Gas & flood detector and Accessories

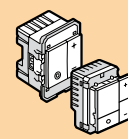

P. 78
Electronic dimmers, Micro switches, Splitters and Access point

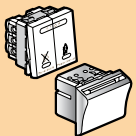

P. 80
Hotel DND & MMR, Keycard and Shaver socket

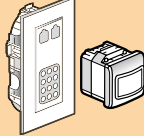

P. 80
Infrared sensors, Clockcon, Keycode and Time switch

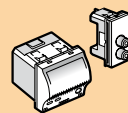

P. 80
Audio-video sockets, Gas & flood detector and Accessories

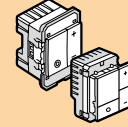

P. 80
Electronic dimmers, Micro switches, Splitters & Access point

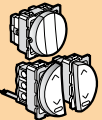

P. 82
Switches, Push buttons and Accessories

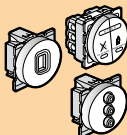

P. 83
Dimmers, Information outlets, Hotel DND & MMR and Audio-video sockets



P. 83
Electronic dimmers and Micro switches

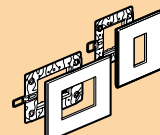



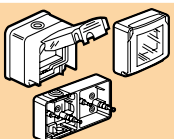





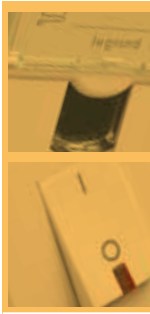
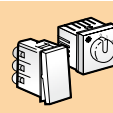
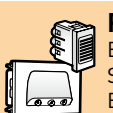

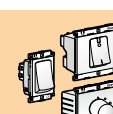

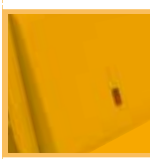
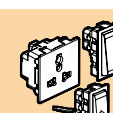
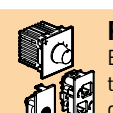

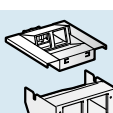
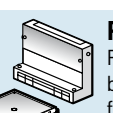

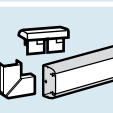
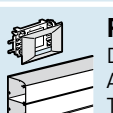
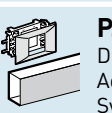

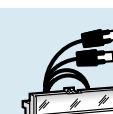
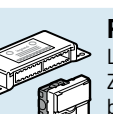

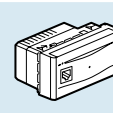
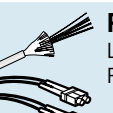

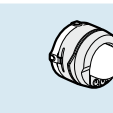

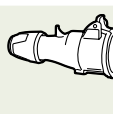
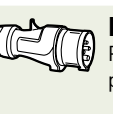

P. 83-85
Square cover plates



P. 87
IP 55 Plexo boxes and Accessories

Round - magnesium mechanisms

 <p>Myrius™ Wiring Accessories</p>	 <p>P. 92-93 Switches, Push buttons, Sockets, Power units and Dimmer and regulators</p> <p>White mechanisms</p>	 <p>P. 93 ELU / Indicators, Skirting light, Indicators, Buzzors, Sensors and Remote unit</p>	 <p>P. 93 NEW! Hospitality functions, Sockets & connectors, Data & voice, USB chargers and Audio & video connectors</p>
 <p>Mylic™ Wiring Accessories</p>	 <p>P. 95 Switches, Push buttons, Sockets, Power units and Dimmer & regulators</p> <p>Black mechanisms</p>	 <p>P. 97 ELU / Indicators, Skirting light, Indicators, Buzzors, Sensors and Remote unit</p>	 <p>P. 97 Hospitality functions, Sockets & connectors, Data & voice, USB chargers and Audio & video connectors</p>
 <p>Mylic™ Wiring Accessories</p>	 <p>P. 100 Mylic switches, Dimmers and Accessories USB charger and remote unit</p> <p>White mechanisms</p>	 <p>P. 100 Mylic energy sockets, power units and MCBs</p>	 <p>P. 100 Mylic TV and RJ 11 telephone sockets and Accessories</p>
 <p>Mylic™ Wiring Accessories</p>	 <p>P. 101 Mylic switches, dimmers, USB charger, remote unit & Accessories</p> <p>Grey Mechanisms</p>	 <p>P. 102 NEW! Mylic energy sockets, power units and MCBs</p>	 <p>P. 102 NEW! Mylic TV, RJ 11 telephone sockets & Accessories</p>
 <p>Britzy Wiring Accessories</p>	 <p>P. 104 NEW! Britzy Switches, sockets and push buttons</p>	 <p>P. 104 NEW! Britzy Data & voice, television sockets, dimmers & regulators & accessories</p>	 <p>P. 105 NEW! Britzy white plate with frames</p>
 <p>Cable Management System and Accessories</p>	 <p>P. 108-110 NEW! Soluflex cable floor system 37/60/90/120 mm height</p>	 <p>P. 110-111 NEW! Raceways & junction boxes for screed floors PVC, Metal and Accessories</p>	 <p>P. 112 NEW! Floor boxes for raised floor, Screed floor and tile/marble</p>
 <p>Cable Management System and Accessories</p>	 <p>P. 117-118 DLP U-PVC Trunking System, Trunking, Mini-Trunking and Accessories</p>	 <p>P. 120-121 DLP U-PVC Adaptable Trunking system and Accessories</p>	 <p>P. 122 DLP Aluminium Adaptable Trunking System, Aluminium Snap-on columns</p>
 <p>VDI Structured Cabling</p>	 <p>P. 132 LCS², cat. 6A Patch panels, Cables and Cords</p>	 <p>P. 132 LCS², cat. 6A Zone distribution boxes and RJ 45 sockets</p>	 <p>P. 133-134 LCS², cat. 6 Patch panels, Cables and Cords</p>
 <p>VDI Structured Cabling</p>	 <p>P. 136-137 Wi-Fi solution</p>	 <p>P. 137-139 LCS² Fibre optic</p>	 <p>P. 139-140 Audio & video sockets and HD 15 amplifier</p>
 <p>Movement Detectors and Door Phones</p>	 <p>P. 145 Movement detectors</p>	 <p>P. 145 NEW! Video door entry system</p>	
 <p>P17 Tempra Pro, Hypra and Plugs & Sockets</p>	 <p>P. 147 P17 Tempra Pro sockets</p>	 <p>P. 147 P17 Tempra Pro plugs</p>	 <p>P. 147-148 P17 Tempra Pro for refrigerated container</p>

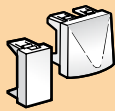

P. 93
Volume controller,
Protectors and
Accessories,
Modular MCBs



P. 94
White plastic plates

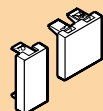

P. 94
Antibacterial
switches +
accessories

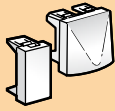

P. 97
Volume controller,
Protectors and
Accessories,
Modular MCBs



P. 98
Black plastic plates

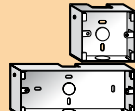

P. 98
Flush mounting &
Surface boxes

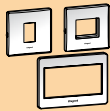

P. 101
Mylinec modular
Plates - White

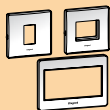

P. 102 NEW!
Mylinec modular plates -
Matt Grey, Pearl white,
Champagne, Silver Alu,
Dark Bronze

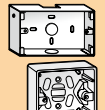

P. 103
Mylinec White
surrounds, flush &
surface boxes

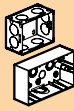

P. 105 NEW!
Britzy Flush & surface
mounting boxes

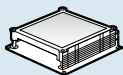

P. 112 NEW!
Floor boxes 3 module,
Heavy Duty in-screed
floor box, Floor access
unit for raised floors

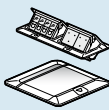

P. 113 NEW!
Pop-up type flush-
mounting boxes
and Power & data
desk Grommets

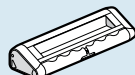

P. 114 NEW!
Desktop multi-outlet
extensions, Flush
mounting power
and data module

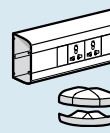

P. 115-116
Snap-On
Trunking 45mm,
Routing sections
and Accessories

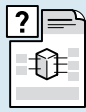

P. 124-125
Selection Chart:
Snap-On trunking

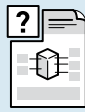

P. 126-127
Selection chart:
DLP U-PVC
adaptable
trunking system



P. 127
Selection Chart:
DLP Mini Trunking
Systems



P. 128-129
Selection Chart :
DLP aluminium
Trunking system

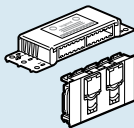

P. 134-135
LCS², cat. 6
Zone distribution
boxes and RJ 45
sockets

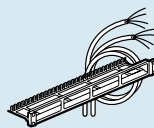

P. 135
LCS², cat. 5e
Patch panels,
Cables and
Cords

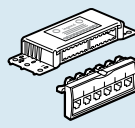

P. 135-136
LCS², cat. 5e
Zone distribution
boxes and RJ 45
sockets

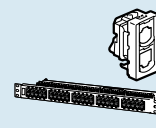

P. 136-137
LCS², Modular
panels, Doubler
sockets and
Telephone panels

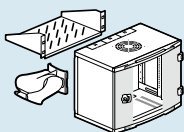

P. 140-143
Enclosure,
Cabinets



P. 149
Hypra industrial
plugs and sockets

Optimized performance up to 6300 A

DMX³ air circuit breakers are available in three frame sizes for three breaking capacities: 50 kA for the DMX³ N designation, 65 kA for DMX³ H and 100 kA for DMX³ L.

The range covers 11 rated currents, between 630 A and 6300 A.

The entire range of DMX³ air circuit breakers are available in fixed and draw-out version.

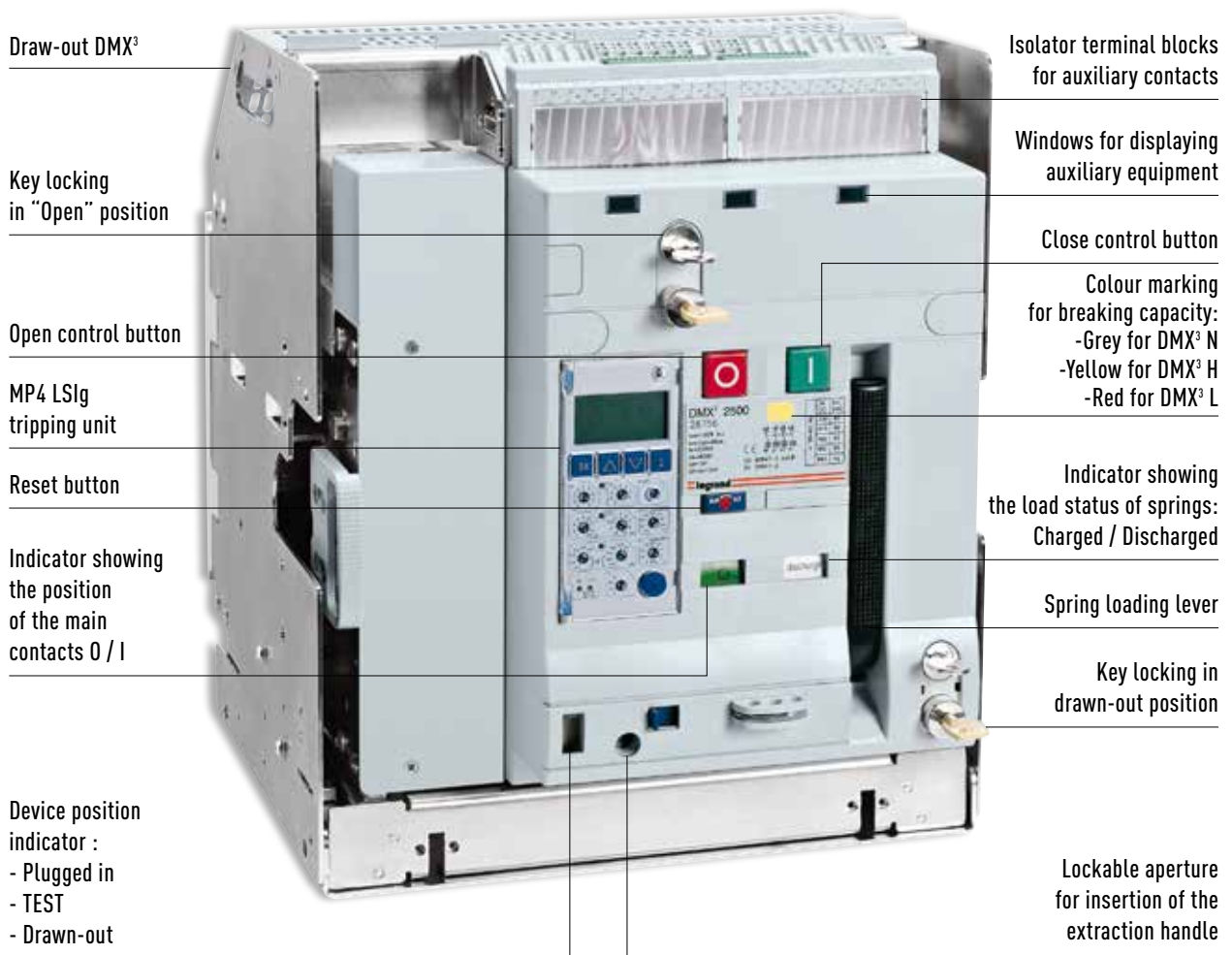

DMX³

air circuit breakers from 630 to 2500 A

Type and frame size	Amps.	Poles	Cat.Nos	Price ₹ / Unit	Pack	
Fixed version						
DMX ³ - N 2500, Icu 50 kA Frame - 1	630 A	3 Pole	0286 20	■	1	
	800 A	3 Pole	0286 21	■	1	
	1000 A	3 Pole	0286 22	■	1	
	1250 A	3 Pole	0286 23	■	1	
	1600 A	3 Pole	0286 24	■	1	
	2000 A	3 Pole	0286 25	■	1	
	2500 A	3 Pole	0286 26	■	1	
	630 A	4 Pole	0286 30	■	1	
	800 A	4 Pole	0286 31	■	1	
	1000 A	4 Pole	0286 32	■	1	
	1250 A	4 Pole	0286 33	■	1	
	1600 A	4 Pole	0286 34	■	1	
	2000 A	4 Pole	0286 35	■	1	
	2500 A	4 Pole	0286 36	■	1	
	DMX ³ - H 2500, Icu 65 kA Frame - 1	630 A	3 Pole	0286 40	■	1
		800 A	3 Pole	0286 41	■	1
		1000 A	3 Pole	0286 42	■	1
		1250 A	3 Pole	0286 43	■	1
1600 A		3 Pole	0286 44	■	1	
2000 A		3 Pole	0286 45	■	1	
2500 A		3 Pole	0286 46	■	1	
630 A		4 Pole	0286 50	■	1	
800 A		4 Pole	0286 51	■	1	
1000 A		4 Pole	0286 52	■	1	
1250 A		4 Pole	0286 53	■	1	
1600 A		4 Pole	0286 54	■	1	
2000 A		4 Pole	0286 55	■	1	
2500 A		4 Pole	0286 56	■	1	
DMX ³ - L 2500, Icu 100 kA Frame - 2		630 A	3 Pole	0286 60	■	1
		800 A	3 Pole	0286 61	■	1
		1000 A	3 Pole	0286 62	■	1
		1250 A	3 Pole	0286 63	■	1
	1600 A	3 Pole	0286 64	■	1	
	2000 A	3 Pole	0286 65	■	1	
	2500 A	3 Pole	0286 66	■	1	
	630 A	4 Pole	0286 70	■	1	
	800 A	4 Pole	0286 71	■	1	
	1000 A	4 Pole	0286 72	■	1	
	1250 A	4 Pole	0286 73	■	1	
	1600 A	4 Pole	0286 74	■	1	
	2000 A	4 Pole	0286 75	■	1	
	2500 A	4 Pole	0286 76	■	1	



0286 56

DMX³

air circuit breakers from 630 to 2500 A

Type and frame size	Amps.	Poles	Cat.Nos	Price ₹ / Unit	Pack	
Draw-out version						
DMX ³ - N 2500, Icu 50 kA Frame - 1	630 A	3 Pole	0287 20	■	1	
	800 A	3 Pole	0287 21	■	1	
	1000 A	3 Pole	0287 22	■	1	
	1250 A	3 Pole	0287 23	■	1	
	1600 A	3 Pole	0287 24	■	1	
	2000 A	3 Pole	0287 25	■	1	
	2500 A	3 Pole	0287 26	■	1	
	630 A	4 Pole	0287 30	■	1	
	800 A	4 Pole	0287 31	■	1	
	1000 A	4 Pole	0287 32	■	1	
	1250 A	4 Pole	0287 33	■	1	
	1600 A	4 Pole	0287 34	■	1	
	2000 A	4 Pole	0287 35	■	1	
	2500 A	4 Pole	0287 36	■	1	
	DMX ³ - H 2500, Icu 65 kA Frame - 1	630 A	3 Pole	0287 40	■	1
		800 A	3 Pole	0287 41	■	1
		1000 A	3 Pole	0287 42	■	1
		1250 A	3 Pole	0287 43	■	1
1600 A		3 Pole	0287 44	■	1	
2000 A		3 Pole	0287 45	■	1	
2500 A		3 Pole	0287 46	■	1	
630 A		4 Pole	0287 50	■	1	
800 A		4 Pole	0287 51	■	1	
1000 A		4 Pole	0287 52	■	1	
1250 A		4 Pole	0287 53	■	1	
1600 A		4 Pole	0287 54	■	1	
2000 A		4 Pole	0287 55	■	1	
2500 A		4 Pole	0287 56	■	1	
DMX ³ - L 2500, Icu 100 kA Frame - 2		630 A	3 Pole	0287 60	■	1
		800 A	3 Pole	0287 61	■	1
		1000 A	3 Pole	0287 62	■	1
		1250 A	3 Pole	0287 63	■	1
	1600 A	3 Pole	0287 64	■	1	
	2000 A	3 Pole	0287 65	■	1	
	2500 A	3 Pole	0287 66	■	1	
	630 A	4 Pole	0287 70	■	1	
	800 A	4 Pole	0287 71	■	1	
	1000 A	4 Pole	0287 72	■	1	
	1250 A	4 Pole	0287 73	■	1	
	1600 A	4 Pole	0287 74	■	1	
	2000 A	4 Pole	0287 75	■	1	
	2500 A	4 Pole	0287 76	■	1	



0287 56

■ Price available on request.

Bold Cat.Nos are products normally available with Legrand (India) Stockists. Cat.Nos that are not bold - delivery within 4 - 8 weeks from the date of order. **Bold packing quantity** is our mandatory packing. Orders to be placed by Legrand (India) Stockist in multiples of the same.

DMX³

air circuit breakers from 3200 to 4000 A

Type and frame size	Amps.	Poles	Cat.Nos	Price ₹ / Unit	Pack
Fixed version					
DMX ³ -N 4000	3200 A	3 Pole	0286 27	■	1
Icu 50 kA	4000 A	3 Pole	0286 28	■	1
Frame - 2	3200 A	4 Pole	0286 37	■	1
	4000 A	4 Pole	0286 38	■	1
DMX ³ -H 4000	3200 A	3 Pole	0286 47	■	1
Icu 65 kA	4000 A	3 Pole	0286 48	■	1
Frame - 2	3200 A	4 Pole	0286 57	■	1
	4000 A	4 Pole	0286 58	■	1
DMX ³ -L 4000	3200 A	3 Pole	0286 67	■	1
Icu 100 kA	4000 A	3 Pole	0286 68	■	1
Frame - 2	3200 A	4 Pole	0286 77	■	1
	4000 A	4 Pole	0286 78	■	1



0286 37

Draw-out version

DMX ³ -N 4000	3200 A	3 Pole	0287 27	■	1
Icu 50 kA	4000 A	3 Pole	0287 28	■	1
Frame - 2	3200 A	4 Pole	0287 37	■	1
	4000 A	4 Pole	0287 38	■	1
DMX ³ -H 4000	3200 A	3 Pole	0287 47	■	1
Icu 65 kA	4000 A	3 Pole	0287 48	■	1
Frame - 2	3200 A	4 Pole	0287 57	■	1
	4000 A	4 Pole	0287 58	■	1
DMX ³ -L 4000	3200 A	3 Pole	0287 67	■	1
Icu 100 kA	4000 A	3 Pole	0287 68	■	1
Frame - 2	3200 A	4 Pole	0287 77	■	1
	4000 A	4 Pole	0287 78	■	1

Air circuit breakers from 5000 to 6300 A

Fixed version

DMX ³ -L 6300	5000 A	3 Pole	0289 50	■	1
Icu 100 kA	6300 A	3 Pole	0289 51	■	1
Frame - 3	5000 A	4 Pole	0289 60	■	1
	6300 A	4 Pole	0289 61	■	1

■ Price available on request.

DMX³

air circuit breakers from 5000 to 6300 A

Type and frame size	Amps.	Poles	Cat.Nos	Price ₹ / Unit	Pack
Draw-out version					
DMX ³ -L 6300	5000 A	3 Pole	0289 52	■	1
Icu 100 kA	6300 A	3 Pole	0289 53	■	1
Frame - 3	5000 A	4 Pole	0289 62	■	1
	6300 A	4 Pole	0289 63	■	1

Trip free switches from 1250 to 6300 A

Fixed version

DMX ³ -I 2500	1250 A	3 Pole	0286 83	■	1
Frame - 1	1600 A	3 Pole	0286 84	■	1
	2000 A	3 Pole	0286 85	■	1
	2500 A	3 Pole	0286 86	■	1
Frame - 2	1250 A	4 Pole	0286 93	■	1
	1600 A	4 Pole	0286 94	■	1
	2000 A	4 Pole	0286 95	■	1
	2500 A	4 Pole	0286 96	■	1
DMX ³ -I 4000	3200 A	3 Pole	0286 87	■	1
Frame - 2	4000 A	3 Pole	0286 88	■	1
	3200 A	4 Pole	0286 97	■	1
	4000 A	4 Pole	0286 98	■	1
DMX ³ -I 6300	6300 A	3 Pole	0289 70	■	1
Frame - 3	6300 A	4 Pole	0289 71	■	1



0286 96

Draw-out version

DMX ³ -I 2500	1250 A	3 Pole	0287 83	■	1
Frame - 1	1600 A	3 Pole	0287 84	■	1
	2000 A	3 Pole	0287 85	■	1
	2500 A	3 Pole	0287 86	■	1
Frame - 2	1250 A	4 Pole	0287 93	■	1
	1600 A	4 Pole	0287 94	■	1
	2000 A	4 Pole	0287 95	■	1
	2500 A	4 Pole	0287 96	■	1
DMX ³ -I 4000	3200 A	3 Pole	0287 87	■	1
Frame - 2	4000 A	3 Pole	0287 88	■	1
	3200 A	4 Pole	0287 97	■	1
	4000 A	4 Pole	0287 98	■	1
DMX ³ -I 6300	6300 A	3 Pole	0289 77	■	1
Frame - 3	6300 A	4 Pole	0289 78	■	1



0287 96

Bold Cat.Nos are products normally available with Legrand (India) Stockists. Cat.Nos that are not bold - delivery within 4 - 8 weeks from the date of order. Bold packing quantity is our mandatory packing. Orders to be placed by Legrand (India) Stockist in multiples of the same.

DMX³

microprocessor based protection units

Cat.Nos	Description	Price ₹ / Unit	Pack
---------	-------------	----------------	------

Microprocessor based protection units MP4

0288 01	Microprocessor based protection unit with LCD screen with Im, tm, Ir, tr and li adjustments on the front	■	1
0288 02	Microprocessor based protection unit with LCD screen with Im, tm, Ir, tr, li, lg and tg adjustments on the front	■	1



0288 02

Microprocessor based protection units MP6

0288 03	Microprocessor based protection unit with Touch screen with Im, tm, Ir, tr and li, adjustments on the front	■	1
0288 04	Microprocessor based protection unit with Touch screen with Im, tm, Ir, tr, li, lg and tg adjustments on the front	■	1



0288 03

Accessories for electronic protection units

0288 05	Communication module (optional) for DMX ³ electronic protection units	■	1
0288 06	12 V DC external power supply for DMX ³ electronic protection units	■	1
0288 10	External neutral CT for DMX ³ 6300	■	1
0288 11 ⁽¹⁾	External neutral CT	■	1
0288 12	Module programmable output	■	1

Rear terminals for Frame - 1 and Frame - 2

Type and frame size	Poles	Cat.Nos	Price ₹ / Unit	Pack
---------------------	-------	---------	----------------	------

Rear terminals

DMX ³ 2500, fixed version, frame - 1	3 Pole	0288 84	■	1
	3 Pole	0288 82	■	1
	4 Pole	0288 85	■	1
	4 Pole	0288 83	■	1
DMX ³ 4000, DMX ³ 6300 fixed version, frame - 2 & 3	3 Pole	0288 92	■	1
	4 Pole	0288 93	■	1
DMX ³ 2500, draw-out version, frame-1	3 Pole	0288 96	■	1
	4 Pole	0288 97	■	1
DMX ³ 4000, DMX ³ 6300 draw-out version, fram - 2 & 3	3 Pole	0288 94	■	1
	4 Pole	0288 95	■	1
DMX ³ 2500, draw-out version, frame-1 suitable for Aluminium	3 Pole	0288 96A	■	1
	4 Pole	0288 97A	■	1
DMX ³ 4000, DMX ³ 6300 draw-out version, frame - 2&3, suitable for Aluminium	3 Pole	0288 94A	■	1
	4 Pole	0288 95A	■	1



0288 84



0288 82



0288 96

■ Price available on request.

(1) Optional accessories to be ordered while ordering electronic protection unit and DMX³ air circuit breakers for factory assembly

DMX³

rear terminals for Frame - 1 and Frame - 2

Type and frame size	Poles	Cat.Nos	Price ₹ / Unit	Pack
---------------------	-------	---------	----------------	------

Spreaders

DMX ³ 2500, fixed version, frame - 1	3 Pole	0288 86	■	1
	3 Pole	0288 88	■	1
	3 Pole	0288 90	■	1
4 Pole	4 Pole	0288 87	■	1
	4 Pole	0288 89	■	1
	4 Pole	0288 91	■	1



0288 91

Equipment for conversion of a fixed device into draw-out device

Bases for draw-out device

DMX ³ /DMX ³ -I 2500, frame - 1	3 Pole	0289 02	■	1
	4 Pole	0289 03	■	1
DMX ³ /DMX ³ -I 4000, frame - 2	3 Pole	0289 04	■	1
	4 Pole	0289 05	■	1
DMX ³ /DMX ³ -I 6300, frame - 3	3 Pole	0289 13	■	1
	4 Pole	0289 14	■	1

Transformation kit for draw-out version

DMX ³ /DMX ³ -I 2500, frame - 1	3 Pole	0289 09	■	1
	4 Pole	0289 10	■	1
DMX ³ /DMX ³ -I 4000, frame - 2	3 Pole	0289 11	■	1
	4 Pole	0289 12	■	1
DMX ³ /DMX ³ -I 6300, frame - 3	3 Pole	0289 15	■	1
	4 Pole	0289 16	■	1

Auxiliaries and accessories

Cat.Nos	Description	Price ₹ / Unit	Pack
---------	-------------	----------------	------

Control and signalling auxiliaries

Shunt trip

0288 48	24 V \sim /=	■	1
0288 49	48 V \sim /=	■	1
0288 50	110 V \sim /=	■	1
0288 51	230 V \sim /=	■	1
0288 52	415 V \sim	■	1



0288 51

Bold Cat.Nos are products normally available with Legrand (India) Stockists. Cat.Nos that are not bold - delivery within 4 - 8 weeks from the date of order. Bold packing quantity is our mandatory packing. Orders to be placed by Legrand (India) Stockist in multiples of the same.

DMX³ auxiliaries and accessories

Cat.Nos	Description	Price ₹ / Unit	Pack
---------	-------------	----------------------	------

Undervoltage releases

0288 55	24 V \sim /=	■	1
0288 56	48 V \sim /=	■	1
0288 57	110 V \sim /=	■	1
0288 58	230 V \sim /=	■	1
0288 59	415 V \sim	■	1



0288 58

Delayed undervoltage releases

0288 62	110 V \sim /=	■	1
0288 63	230 V \sim /=	■	1

Motor operators

0288 34	24 V \sim /=	■	1
0288 35	48 V \sim /=	■	1
0288 36	110 V \sim /=	■	1
0288 37	230 V \sim /=	■	1
0288 38	415 V \sim	■	1



0288 37

Closing coils

0288 41	24 V \sim /=	■	1
0288 42	48 V \sim /=	■	1
0288 43	110 V \sim /=	■	1
0288 44	230 V \sim /=	■	1
0288 45	415 V \sim	■	1



0288 44

Locking

Key locking in "open" position

0288 31	Ronis lock (key included)	■	1
0288 29	Ronies key barrel	■	1
0288 30	Profalux lock (key included)	■	1
0288 28	2 hole support frame for Ronis locks	■	1

Key locking in the draw-out position

0288 33	Ronis lock (key included)	■	1
0288 32	Profalux lock (key included)	■	1



0288 32
+
0288 33

Door locking

0288 20	Left-hand and right-hand side mounting	■	1
---------	---	---	---

■ Price available on request.
Red Cat.Nos - new products

DMX³ auxiliaries and accessories

Cat.Nos	Description	Price ₹ / Unit	Pack
---------	-------------	----------------------	------

Padlocks in "open" position

0288 21	Padlocking system for ACB	■	1
0288 24	Padlocking for button	■	1
0288 26	Padlocking system for shutters	■	1

Automation control unit

4226 80	Standard unit	■	1
4226 82	Advanced unit	■	1
4226 89	Communication module	■	1



4226 82

Equipment for supply invertors

0288 64	Interlock for DMX ³ 2500	■	1
0288 65	Interlock for DMX ³ 4000	■	1
0288 66	Interlock for DMX ³ 6300	■	1



0288 64

Cable interlock

0289 20	Type 1 (2600 mm)	■	1
0289 21	Type 2 (3000 mm)	■	1
0289 22	Type 3 (3600 mm)	■	1
0289 23	Type 4 (4000 mm)	■	1
0289 24	Type 5 (4600 mm)	■	1
0289 25	Type 6 (5600 mm)	■	1

Accessories

0288 25	Rating mis-insertion device	■	1
0288 23	Operations counter	■	1
0288 13	Inserted / test / Draw-out Contact	■	1
0288 14	Contact "ready to close" with charged springs	■	1
0288 15	Set of additional signalling contacts	■	1
0288 16	Signal Contact for Auxiliaries	■	1
0288 22	Door sealing IP 40	■	1
0288 79	Lifting plate	■	1

Bold Cat.Nos are products normally available with Legrand (India) Stockists.
Cat.Nos that are not bold - delivery within 4 - 8 weeks from the date of order.
Bold packing quantity is our mandatory packing. Orders to be placed by
Legrand (India) Stockist in multiples of the same.

MCCBs: DRX™ and DPX³

Legrand now has two distinct ranges of MCCBs

DRX™ -- Thermal magnetic release only.

DPX³ -- Thermal magnetic and Microprocessor releases.

DRX™, is available upto 100 A, and finds applications in both, residential and commercial. Accessories like the Rotary Handles, Moulded Shrouds, Cage Terminals etc. are available in the range.



DRX 100

Current rating from 60 to 100 A
Breaking Capacity 10 kA
Thermal Magnetic release

DPX³ available in 5 frame sizes, covers requirements from 16 A upto 1600 A, with adjustable thermal and magnetic releases. Optional accessories like Rotary Handles, Motor Operators etc. are also available. **DPX³** can also be used as an Automatic Transfer Switch.

Ics = 100% Icu



DPX³ 160

Current rating from 16 to 160 A
Breaking capacity 16 kA to 50 kA
Thermal magnetic release
Optional integrated earth leakage available



DPX³ 250

Current rating 40 Amp to 250 Amp
Breaking capacity 25 kA to 70 kA
Thermal magnetic release & microprocessor release
Optional integrated earth leakage available



DPX³ 630

Thermal Magnetic & Electronic type
Current rating – 320 A to 630 A
Breaking capacity – 36 kA to 100 kA



DPX³ 1600

Thermal Magnetic & Electronic type
Current rating – 800 A to 1600 A
Breaking capacity – 36kA to 100 kA

DRX™ MCCB

Type and frame size	Amps.	Poles	Cat.Nos	LP* ₹ / Unit	Pack
---------------------	-------	-------	---------	-----------------	------

DRX MCCBs

DRX 100 Icu = 10 kA	60 A	3 Pole	0270 06	2368	1/12
	63 A	3 Pole	0270 39	2368	1/12
	75 A	3 Pole	0270 07	2368	1/12
	100 A	3 Pole	0270 08	2368	1/12
	60 A	4 Pole	0270 16	4238	1/12
	63 A	4 Pole	0270 29	4238	1/12
	75 A	4 Pole	0270 17	4238	1/12
	100 A	4 Pole	0270 18	4238	1/12

Description	Cat.Nos	LP* ₹ / Unit	Pack
-------------	---------	-----------------	------

DIN rail adaptor

DRX 100	0271 87	410	1
---------	---------	-----	---

Rotary handles - Direct

DRX 100	6687 70	1134	1
---------	----------------	------	---

Rotary handles - vary-depth

DRX 100	6687 71	1962	1
---------	----------------	------	---

Padlocking support for operating handle

DRX 100	0271 80	126	1
---------	---------	-----	---

Connection accessories

Set of 2 shields for 3 pole	0271 81	98	1
-----------------------------	---------	----	---

Sealable terminal shields (moulded shrouds)

For DRX 100 - 3 pole	0271 83	1338	1
For DRX 100 - 4 pole	0271 84	1404	1

Cage terminals

For DRX 100 - 3 pole	0271 71	240	1
For DRX 100 - 4 pole	0271 73	264	1

Electrical accessories

Block with 1 auxiliary (1 AUX)	0271 40	848	1
Block with 1 alarm (1 AL)	0271 41	868	1
Block with 1 auxiliary + 1 alarm (1 AUX + 1 AL)	0271 42	1424	1

Current shunt coils

200/277 V~ and ∞	0271 54	1770	1
380/480 V~ and ∞	0271 55	1770	1

Undervoltage release coils

200/240 V~	0271 64	2052	1
380/415 V~	0271 65	2082	1

DRX spreader links

3 Links set for TP	6250 10	162	1
4 Links set for FP	6250 11	242	1

*LP - List Price Inclusive of excise duty but exclusive of sales tax or any other taxes.

Red Cat.Nos - new products

P17 TEMPRA PRO

Ensuring a quick installation

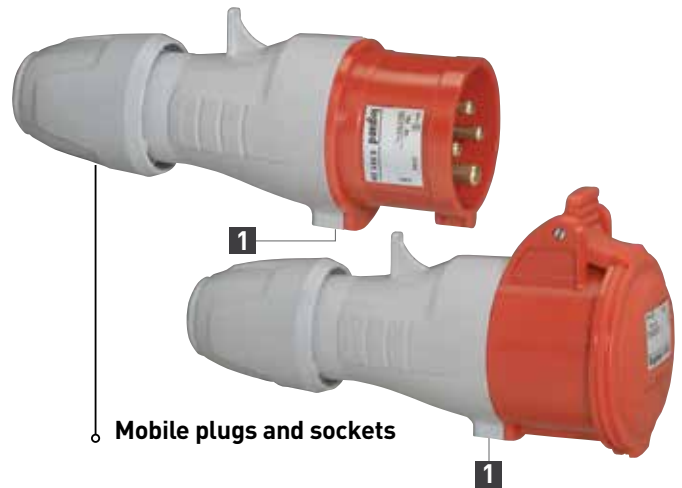

Mobile plugs and sockets

1 QUICK OPENING/CLOSING SYSTEM

Unlocked by pressing with a screwdriver. Marking indicates the location for the locking clip. Opened by turning the 2 parts in opposite directions.



Bold Cat.Nos are products normally available with Legrand (India) Stockists. Cat.Nos that are not bold - delivery within 4 - 8 weeks from the date of order. Bold packing quantity is our mandatory packing. Orders to be placed by Legrand (India) Stockist in multiples of the same.

DPX³ 160 thermal magnetic MCCBs from 16 to 160 A Ics = 100% Icu

Type and frame sizes	Amps.	Poles	Cat.Nos	LP* ₹ / Unit	Pack
MCCBs					
DPX ³ 160 ① Icu = 16 kA	16 A	3 Pole	4200 00	5736	1
	25 A	3 Pole	4200 01	5736	1
	40 A	3 Pole	4200 02	5736	1
	63 A	3 Pole	4200 03	5466	1
	80 A	3 Pole	4200 04	5466	1
	100 A	3 Pole	4200 05	5466	1
	125 A	3 Pole	4200 06	6108	1
	160 A	3 Pole	4200 07	7540	1
	16 A	4 Pole	4200 10	7390	1
	25 A	4 Pole	4200 11	7390	1
	40 A	4 Pole	4200 12	7390	1
	63 A	4 Pole	4200 13	7024	1
	80 A	4 Pole	4200 14	7024	1
	100 A	4 Pole	4200 15	7024	1
	125 A	4 Pole	4200 16	7798	1
	160 A	4 Pole	4200 17	9618	1
	DPX ³ 160 ① Icu = 25 kA	16 A	3 Pole	4200 40	8726
25 A		3 Pole	4200 41	8726	1
40 A		3 Pole	4200 42	8726	1
63 A		3 Pole	4200 43	7506	1
80 A		3 Pole	4200 44	7506	1
100 A		3 Pole	4200 45	7506	1
125 A		3 Pole	4200 46	8310	1
160 A		3 Pole	4200 47	10066	1
16 A		4 Pole	4200 50	11662	1
25 A		4 Pole	4200 51	11662	1
40 A		4 Pole	4200 52	11662	1
63 A		4 Pole	4200 53	10364	1
80 A		4 Pole	4200 54	10364	1
100 A		4 Pole	4200 55	10364	1
125 A		4 Pole	4200 56	11932	1
160 A		4 Pole	4200 57	14522	1
DPX ³ 160 ① Icu = 36 kA		16 A	3 Pole	4200 80	11112
	25 A	3 Pole	4200 81	11112	1
	40 A	3 Pole	4200 82	11112	1
	63 A	3 Pole	4200 83	8836	1
	80 A	3 Pole	4200 84	8836	1
	100 A	3 Pole	4200 85	8836	1
	125 A	3 Pole	4200 86	10388	1
	160 A	3 Pole	4200 87	13258	1
	16 A	4 Pole	4200 90	13970	1
	25 A	4 Pole	4200 91	13970	1
	40 A	4 Pole	4200 92	13970	1
	63 A	4 Pole	4200 93	12082	1
	80 A	4 Pole	4200 94	12082	1
	100 A	4 Pole	4200 95	12082	1
	125 A	4 Pole	4200 96	13800	1
	160 A	4 Pole	4200 97	16644	1



4200 00



4200 10



4200 37



4201 57

DPX³ 160 thermal magnetic MCCBs from 16 to 160 A Ics = 100% Icu

Type and frame sizes	Amps.	Poles	Cat.Nos	LP* ₹ / Unit	Pack	
MCCBs						
DPX ³ 160 ① Icu = 50 kA	16 A	3 Pole	4201 20	13638	1	
	25 A	3 Pole	4201 21	13638	1	
	40 A	3 Pole	4201 22	13638	1	
	63 A	3 Pole	4201 23	10204	1	
	80 A	3 Pole	4201 24	10204	1	
	100 A	3 Pole	4201 25	10204	1	
	125 A	3 Pole	4201 26	13770	1	
	160 A	3 Pole	4201 27	17458	1	
	16 A	4 Pole	4201 30	18300	1	
	25 A	4 Pole	4201 31	18300	1	
	40 A	4 Pole	4201 32	18300	1	
	63 A	4 Pole	4201 33	15836	1	
	80 A	4 Pole	4201 34	15836	1	
	100 A	4 Pole	4201 35	15836	1	
	125 A	4 Pole	4201 36	18194	1	
	160 A	4 Pole	4201 37	20942	1	
	MCCBs with electronic earth leakage module					
DPX ³ 160 ① Icu = 16 kA	16 A	4 Pole	4200 30	26592	1	
	25 A	4 Pole	4200 31	26476	1	
	40 A	4 Pole	4200 32	25598	1	
	63 A	4 Pole	4200 33	25440	1	
	80 A	4 Pole	4200 34	25358	1	
	100 A	4 Pole	4200 35	25358	1	
	125 A	4 Pole	4200 36	27098	1	
	160 A	4 Pole	4200 37	32936	1	
	DPX ³ 160 ① Icu = 25 kA	16 A	4 Pole	4200 70	32960	1
		25 A	4 Pole	4200 71	32624	1
40 A		4 Pole	4200 72	32212	1	
63 A		4 Pole	4200 73	28972	1	
80 A		4 Pole	4200 74	29368	1	
100 A		4 Pole	4200 75	29088	1	
125 A		4 Pole	4200 76	31546	1	
160 A		4 Pole	4200 77	37850	1	
DPX ³ 160 ① Icu = 36 kA	16 A	4 Pole	4201 10	34608	1	
	25 A	4 Pole	4201 11	33378	1	
	40 A	4 Pole	4201 12	33918	1	
	63 A	4 Pole	4201 13	30998	1	
	80 A	4 Pole	4201 14	31012	1	
	100 A	4 Pole	4201 15	30714	1	
	125 A	4 Pole	4201 16	33502	1	
	160 A	4 Pole	4201 17	40120	1	
DPX ³ 160 ① Icu = 50 kA	16 A	4 Pole	4201 50	38972	1	
	25 A	4 Pole	4201 51	37226	1	
	40 A	4 Pole	4201 52	38194	1	
	63 A	4 Pole	4201 53	35762	1	
	80 A	4 Pole	4201 54	35440	1	
	100 A	4 Pole	4201 55	35440	1	
	125 A	4 Pole	4201 56	37724	1	
	160 A	4 Pole	4201 57	45180	1	

*LP-List Price Inclusive of excise duty but exclusive of sales tax or any other taxes.

Bold Cat.Nos are products normally available with Legrand (India) Stockists. Cat.Nos that are not bold - delivery within 4 - 8 weeks from the date of order. Bold packing quantity is our mandatory packing. Orders to be placed by Legrand (India) Stockist in multiples of the same.

DPX³ 250 thermal magnetic MCCBs from 100 to 250 A Ics = 100% Icu



4202 05

Type and frame sizes	Amps.	Poles	Cat.Nos	LP* ₹ / Unit	Pack
----------------------	-------	-------	---------	-----------------	------

MCCBs

DPX ³ 250 Icu = 25 kA	100 A	3 Pole	4202 05	9466	1
	160 A	3 Pole	4202 07	13996	1
	200 A	3 Pole	4202 08	17392	1
	250 A	3 Pole	4202 09	21736	1
	100 A	4 Pole	4202 15	11834	1
	160 A	4 Pole	4202 17	17498	1
	200 A	4 Pole	4202 18	21736	1
	250 A	4 Pole	4202 19	27170	1
DPX ³ 250 Icu = 36 kA	100 A	3 Pole	4202 35	16422	1
	160 A	3 Pole	4202 37	17498	1
	200 A	3 Pole	4202 38	20180	1
	250 A	3 Pole	4202 39	22090	1
	100 A	4 Pole	4202 45	17624	1
	160 A	4 Pole	4202 47	21908	1
	200 A	4 Pole	4202 48	24634	1
	250 A	4 Pole	4202 49	28280	1
DPX ³ 250 Icu = 50 kA	100 A	3 Pole	4202 65	17870	1
	160 A	3 Pole	4202 67	19490	1
	200 A	3 Pole	4202 68	22598	1
	250 A	3 Pole	4202 69	24576	1
	100 A	4 Pole	4202 75	22626	1
	160 A	4 Pole	4202 77	24506	1
	200 A	4 Pole	4202 78	28120	1
	250 A	4 Pole	4202 79	30570	1
DPX ³ 250 Icu = 70 kA	100 A	3 Pole	4206 05	20286	1
	160 A	3 Pole	4206 07	25176	1
	200 A	3 Pole	4206 08	30842	1
	250 A	3 Pole	4206 09	32728	1
	100 A	4 Pole	4206 15	22656	1
	160 A	4 Pole	4206 17	31470	1
	200 A	4 Pole	4206 18	38126	1
	250 A	4 Pole	4206 19	39650	1

MCCBs with electronic earth leakage module



4202 25

DPX ³ 250 Icu = 25 kA	100 A	4 Pole	4202 25	39722	1
	160 A	4 Pole	4202 27	46750	1
	200 A	4 Pole	4202 28	48520	1
	250 A	4 Pole	4202 29	51818	1
DPX ³ 250 Icu = 36 kA	100 A	4 Pole	4202 55	44098	1
	160 A	4 Pole	4202 57	51396	1
	200 A	4 Pole	4202 58	56860	1
	250 A	4 Pole	4202 59	57522	1

*LP-List Price Inclusive of excise duty but exclusive of sales tax or any other taxes.

DPX³ 250 thermal magnetic MCCBs from 100 to 250 A Ics = 100% Icu

Type and frame sizes	Amps.	Poles	Cat.Nos	LP* ₹ / Unit	Pack
----------------------	-------	-------	---------	-----------------	------

MCCBs with electronic earth leakage module

DPX ³ 250 Icu = 50 kA	100 A	4 Pole	4202 85	51972	1
	160 A	4 Pole	4202 87	59998	1
	200 A	4 Pole	4202 88	63158	1
	250 A	4 Pole	4202 89	67042	1
DPX ³ 250 Icu = 70 kA	100 A	4 Pole	4206 25	52306	1
	160 A	4 Pole	4206 27	65390	1
	200 A	4 Pole	4206 28	71408	1
	250 A	4 Pole	4206 29	74728	1

DPX³ 250 electronic release MCCBs from 40 to 250 A Ics = 100% Icu

MCCBs

DPX ³ 250 Icu = 25 kA	40 A	3 Pole	4203 02	15816	1
	100 A	3 Pole	4203 05	15816	1
	160 A	3 Pole	4203 07	20376	1
	250 A	3 Pole	4203 09	28012	1
	40 A	4 Pole	4203 12	21216	1
	100 A	4 Pole	4203 15	21216	1
	160 A	4 Pole	4203 17	26744	1
	250 A	4 Pole	4203 19	35906	1
DPX ³ 250 Icu = 36 kA	40 A	3 Pole	4203 32	16716	1
	100 A	3 Pole	4203 35	16716	1
	160 A	3 Pole	4203 37	21862	1
	250 A	3 Pole	4203 39	30562	1
	40 A	4 Pole	4203 42	22246	1
	100 A	4 Pole	4203 45	22246	1
	160 A	4 Pole	4203 47	29892	1
	250 A	4 Pole	4203 49	39858	1
DPX ³ 250 Icu = 50 kA	40	3 Pole	4203 62	20282	1
	100	3 Pole	4203 65	21264	1
	160	3 Pole	4203 67	26230	1
	250	3 Pole	4203 69	32472	1
	40 A	4 Pole	4203 72	25838	1
	100 A	4 Pole	4203 75	25716	1
	160 A	4 Pole	4203 77	32154	1
	250 A	4 Pole	4203 79	42150	1
DPX ³ 250 Icu = 70 kA	40 A	3 Pole	4206 35	25196	1
	100 A	3 Pole	4206 37	25440	1
	160 A	3 Pole	4206 38	38020	1
	250 A	3 Pole	4206 39	43278	1
	40 A	4 Pole	4206 45	33032	1
	100 A	4 Pole	4206 47	32716	1
	160 A	4 Pole	4206 48	43542	1
	250 A	4 Pole	4206 49	55584	1



4203 69

Bold Cat.Nos are products normally available with Legrand (India) Stockists. Cat.Nos that are not bold - delivery within 4 - 8 weeks from the date of order. Bold packing quantity is our mandatory packing. Orders to be placed by Legrand (India) Stockist in multiples of the same.

DPX³ 250 electronic release

MCCBs from 40 to 250 A Ics = 100% Icu

Type and frame sizes	Amps.	Poles	Cat.Nos	LP* ₹ / Unit	Pack
----------------------	-------	-------	---------	-----------------	------

MCCBs with electronic earth leakage module

DPX ³ 250 ② Icu = 25 kA	40 A	4 Pole	4203 22	63800	1
	100 A	4 Pole	4203 25	63800	1
	160 A	4 Pole	4203 27	68038	1
	250 A	4 Pole	4203 29	79836	1
DPX ³ 250 ② Icu = 36 kA	40 A	4 Pole	4203 52	64910	1
	100 A	4 Pole	4203 55	64910	1
	160 A	4 Pole	4203 57	71334	1
	250 A	4 Pole	4203 59	83206	1
DPX ³ 250 ② Icu = 50 kA	40 A	4 Pole	4203 82	68336	1
	100 A	4 Pole	4203 85	68336	1
	160 A	4 Pole	4203 87	73814	1
	250 A	4 Pole	4203 89	85802	1
DPX ³ 250 ② Icu = 70 kA	40 A	4 Pole	4206 55	74464	1
	100 A	4 Pole	4206 57	74464	1
	160 A	4 Pole	4206 58	84018	1
	250 A	4 Pole	4206 59	114712	1

MCCBs with energy metering central unit

DPX ³ 250 ② Icu = 25 kA	40 A	3 Pole	4204 02	48280	1
	100 A	3 Pole	4204 05	48280	1
	160 A	3 Pole	4204 07	52296	1
	250 A	3 Pole	4204 09	56572	1
DPX ³ 250 ② Icu = 36 kA	40 A	4 Pole	4204 12	52748	1
	100 A	4 Pole	4204 15	52748	1
	160 A	4 Pole	4204 17	57096	1
	250 A	4 Pole	4204 19	64740	1
	40 A	3 Pole	4204 32	49280	1
	100 A	3 Pole	4204 35	49280	1
	160 A	3 Pole	4204 37	53666	1
	250 A	3 Pole	4204 39	57938	1
DPX ³ 250 ② Icu = 50 kA	40 A	4 Pole	4204 42	53802	1
	100 A	4 Pole	4204 45	53802	1
	160 A	4 Pole	4204 47	60252	1
	250 A	4 Pole	4204 49	67662	1
	40 A	3 Pole	4204 62	52454	1
	100 A	3 Pole	4204 65	52454	1
	160 A	3 Pole	4204 67	57544	1
	250 A	3 Pole	4204 69	60804	1
DPX ³ 250 ② Icu = 70 kA	40 A	4 Pole	4204 72	57068	1
	100 A	4 Pole	4204 75	57068	1
	160 A	4 Pole	4204 77	62632	1
	250 A	4 Pole	4204 79	70442	1

*LP-List Price Inclusive of excise duty but exclusive of sales tax or any other taxes.



4203 25

DPX³ 250 electronic release

MCCBs from 40 to 250 A Ics = 100% Icu

Type and frame sizes	Amps.	Poles	Cat.Nos	LP* ₹ / Unit	Pack
----------------------	-------	-------	---------	-----------------	------

MCCBs with energy metering central unit

DPX ³ 250 ② Icu = 70 kA	40 A	3 Pole	4206 65	56612	1
	100 A	3 Pole	4206 67	56612	1
	160 A	3 Pole	4206 68	67530	1
	250 A	3 Pole	4206 69	67642	1
DPX ³ 250 ② Icu = 50 kA	40 A	4 Pole	420675	62914	1
	100 A	4 Pole	420677	62914	1
	160 A	4 Pole	420678	72020	1
	250 A	4 Pole	420679	98406	1



4206 79

MCCBs with energy metering central unit and electronic earth leakage module

DPX ³ 250 ② Icu = 25 kA	40 A	4 Pole	4204 22	85568	1
	100 A	4 Pole	4204 25	85568	1
	160 A	4 Pole	4204 27	90044	1
	250 A	4 Pole	4204 29	101290	1
DPX ³ 250 ② Icu = 36 kA	40 A	4 Pole	4204 52	86656	1
	100 A	4 Pole	4204 55	86656	1
	160 A	4 Pole	4204 57	93286	1
	250 A	4 Pole	4204 59	102987	1
DPX ³ 250 ② Icu = 50 kA	40 A	4 Pole	4204 82	90012	1
	100 A	4 Pole	4204 85	90012	1
	160 A	4 Pole	4204 87	95732	1
	250 A	4 Pole	4204 89	107538	1
DPX ³ 250 ② Icu = 70 kA	40 A	4 Pole	4206 85	96022	1
	100 A	4 Pole	4206 87	96022	1
	160 A	4 Pole	4206 88	105390	1
	250 A	4 Pole	4206 89	133964	1



4204 25

Microprocessor based release Sg MCCBs

DPX ³ 250 ② Icu = 25 kA	40 A	3 Pole	4205 02	38664	1
	100 A	3 Pole	4205 05	38664	1
	160 A	3 Pole	4205 07	42648	1
	250 A	3 Pole	4205 09	47086	1
DPX ³ 250 ② Icu = 36 kA	40 A	4 Pole	4205 12	43318	1
	100 A	4 Pole	4205 15	43318	1
	160 A	4 Pole	4205 17	47628	1
	250 A	4 Pole	4205 19	55338	1
DPX ³ 250 ② Icu = 50 kA	40 A	3 Pole	4205 22	39894	1
	100 A	3 Pole	4205 25	39894	1
	160 A	3 Pole	4205 27	44064	1
	250 A	3 Pole	4205 29	48024	1
	40 A	4 Pole	4205 32	44636	1
	100 A	4 Pole	4205 35	44636	1
	160 A	4 Pole	4205 37	50888	1
	250 A	4 Pole	4205 39	59024	1

Bold Cat.Nos are products normally available with Legrand (India) Stockists. Cat.Nos that are not bold - delivery within 4 - 8 weeks from the date of order. Bold packing quantity is our mandatory packing. Orders to be placed by Legrand (India) Stockist in multiples of the same.

DPX³ 250
Microprocessor based release
MCCBs from 40 to 250 A Ics = 100% Icu

Type and frame sizes	Amps.	Poles	Cat.Nos	LP* ₹ / Unit	Pack
----------------------	-------	-------	---------	--------------	------

Microprocessor based release Sg MCCBs

DPX ³ 250 Ⓢ Icu = 50 kA	40 A	3 Pole	4205 42	43012	1
	100 A	3 Pole	4205 45	43012	1
	160 A	3 Pole	4205 47	48078	1
	250 A	3 Pole	4205 49	50978	1
	40 A	4 Pole	4205 52	48048	1
	100 A	4 Pole	4205 55	48048	1
	160 A	4 Pole	4205 57	53368	1
	250 A	4 Pole	4205 59	61578	1
DPX ³ 250 Ⓢ Icu = 70 kA	40 A	3 Pole	4206 92	48998	1
	100 A	3 Pole	4206 95	48998	1
	160 A	3 Pole	4206 97	60482	1
	250 A	3 Pole	4206 99	62082	1
	40 A	4 Pole	4207 02	55794	1
	100 A	4 Pole	4207 05	55794	1
	160 A	4 Pole	4207 07	65616	1
	250 A	4 Pole	4207 09	95116	1

DPX³ 630
thermal magnetic release
MCCBs from 250 to 630 A Ics = 100% Icu

MCCBs thermal magnetic release

DPX ³ 630 Ⓢ Icu = 36 kA	320 A	3 Pole	4220 01	26762	1
	400 A	3 Pole	4220 02	26762	1
	500 A	3 Pole	4220 03	31044	1
	630 A	3 Pole	4220 04	33136	1
	320 A	4 Pole	4220 06	33552	1
	400 A	4 Pole	4220 07	33552	1
	500 A	4 Pole	4220 08	39156	1
	630 A	4 Pole	4220 09	41320	1
	DPX ³ 630 Ⓢ Icu = 50 kA	320 A	3 Pole	4220 15	28832
400 A		3 Pole	4220 16	28832	1
500 A		3 Pole	4220 17	33748	1
630 A		3 Pole	4220 18	36170	1
320 A		4 Pole	4220 20	35994	1
400 A		4 Pole	4220 21	35994	1
500 A		4 Pole	4220 22	43224	1
630 A		4 Pole	4220 23	45860	1
DPX ³ 630 Ⓢ Icu = 70 kA		320 A	3 Pole	4220 29	33088
	400 A	3 Pole	4220 30	33088	1
	500 A	3 Pole	4220 31	42404	1
	630 A	3 Pole	4220 32	44438	1
	320 A	4 Pole	4220 34	40874	1
	400 A	4 Pole	4220 35	40874	1
	500 A	4 Pole	4220 36	54278	1
	630 A	4 Pole	4220 37	56018	1

■ Price available on request.

*LP -List Price Inclusive of excise duty but exclusive of sales tax or any other taxes.

DPX³ 630 - thermal magnetic release
MCCBs from 250 to 630 A Ics = 100% Icu

Type and frame sizes	Amps.	Poles	Cat.Nos	LP* ₹ / Unit	Pack
----------------------	-------	-------	---------	--------------	------

MCCBs thermal magnetic release

DPX ³ 630 Ⓢ Icu = 100 kA	320 A	3 Pole	4220 43	■	1
	400 A	3 Pole	4220 44	■	1
	500 A	3 Pole	4220 45	■	1
	630 A	3 Pole	4220 46	■	1
	320 A	4 Pole	4220 48	■	1
	400 A	4 Pole	4220 49	■	1
	500 A	4 Pole	4220 50	■	1
	630 A	4 Pole	4220 51	■	1

DPX³ 630
S2 electronic release
MCCBs from 250 to 630 A Ics = 100% Icu

MCCBs electronic based release S2

DPX ³ 630 Ⓢ Icu = 36 kA	320 A	3 Pole	4220 57	33496	1
	400 A	3 Pole	4220 58	33496	1
	500 A	3 Pole	4220 59	37146	1
	630 A	3 Pole	4220 60	37146	1
DPX ³ 630 Ⓢ Icu = 50 kA	320 A	4 Pole	4220 62	40206	1
	400 A	4 Pole	4220 63	40206	1
	500 A	4 Pole	4220 64	48758	1
	630 A	4 Pole	4220 65	48758	1
	320 A	3 Pole	4220 67	36448	1
	400 A	3 Pole	4220 68	36448	1
	500 A	3 Pole	4220 69	45848	1
	630 A	3 Pole	4220 70	45848	1
DPX ³ 630 Ⓢ Icu = 70 kA	320 A	4 Pole	4220 72	45684	1
	400 A	4 Pole	4220 73	45684	1
	500 A	4 Pole	4220 74	53792	1
	630 A	4 Pole	4220 75	53792	1
	320 A	3 Pole	4220 77	43470	1
	400 A	3 Pole	4220 78	43470	1
	500 A	3 Pole	4220 79	49128	1
	630 A	3 Pole	4220 80	49128	1
	320 A	4 Pole	4220 82	56276	1
DPX ³ 630 Ⓢ Icu = 100 kA	400 A	4 Pole	4220 83	56276	1
	500 A	4 Pole	4220 84	62852	1
	630 A	4 Pole	4220 85	62852	1
	320 A	3 Pole	4220 87	■	1
	400 A	3 Pole	4220 88	■	1
	500 A	3 Pole	4220 89	■	1
	630 A	3 Pole	4220 90	■	1
	320 A	4 Pole	4220 92	■	1
	400 A	4 Pole	4220 93	■	1
	500 A	4 Pole	4220 94	■	1
630 A	4 Pole	4220 95	■	1	

Bold Cat.Nos are products normally available with Legrand (India) Stockists. Cat.Nos that are not bold - delivery within 4 - 8 weeks from the date of order. Bold packing quantity is our mandatory packing. Orders to be placed by Legrand (India) Stockist in multiples of the same.

DPX³ 630

S2 electronic release MCCBs from 250 to 630 A

Type and frame sizes	Amps.	Poles	Cat.Nos	LP* ₹ / Unit	Pack
----------------------	-------	-------	---------	-----------------	------

MCCBs electronic release S2 with energy metering central unit

DPX ³ 630 Ⓢ Icu = 36 kA	320 A	3 Pole	4220 97	46004	1
	400 A	3 Pole	4220 98	46004	1
	500 A	3 Pole	4220 99	49688	1
	630 A	3 Pole	4221 00	49688	1
	320 A	4 Pole	4221 02	54994	1
	400 A	4 Pole	4221 03	54994	1
	500 A	4 Pole	4221 04	61412	1
	630 A	4 Pole	4221 05	61412	1
DPX ³ 630 Ⓢ Icu = 50 kA	320 A	3 Pole	4221 07	48632	1
	400 A	3 Pole	4221 08	48632	1
	500 A	3 Pole	4221 09	58476	1
	630 A	3 Pole	4221 10	58476	1
	320 A	4 Pole	4221 12	58308	1
	400 A	4 Pole	4221 13	58308	1
	500 A	4 Pole	4221 14	65976	1
	630 A	4 Pole	4221 15	65976	1
DPX ³ 630 Ⓢ Icu = 70 kA	320 A	3 Pole	4221 17	57870	1
	400 A	3 Pole	4221 18	57870	1
	500 A	3 Pole	4221 19	61312	1
	630 A	3 Pole	4221 20	61312	1
	320 A	4 Pole	4221 22	68462	1
	400 A	4 Pole	4221 23	68462	1
	500 A	4 Pole	4221 24	75036	1
	630 A	4 Pole	4221 25	75036	1
DPX ³ 630 Ⓢ Icu = 100 kA	320 A	3 Pole	4221 27	■	1
	400 A	3 Pole	4221 28	■	1
	500 A	3 Pole	4221 29	■	1
	630 A	3 Pole	4221 30	■	1
	320 A	4 Pole	4221 32	■	1
	400 A	4 Pole	4221 33	■	1
	500 A	4 Pole	4221 34	■	1
	630 A	4 Pole	4221 35	■	1

MCCBs electronic release Sg

DPX ³ 630 Ⓢ Icu = 36 kA	320 A	3 Pole	4221 37	45070	1
	400 A	3 Pole	4221 38	45070	1
	500 A	3 Pole	4221 39	49034	1
	630 A	3 Pole	4221 40	49034	1
DPX ³ 630 Ⓢ	320 A	4 Pole	4221 42	52700	1
	400 A	4 Pole	4221 43	52700	1
	500 A	4 Pole	4221 44	61890	1
	630 A	4 Pole	4221 45	61890	1



4221 38



4221 43

■ Price available on request.

*LP -List Price Inclusive of excise duty but exclusive of sales tax or any other taxes.

DPX³ 630

S2 electronic release MCCBs from 250 to 630 A

Type and frame sizes	Amps.	Poles	Cat.Nos	LP* ₹ / Unit	Pack
----------------------	-------	-------	---------	-----------------	------

MCCBs electronic release Sg

DPX ³ 630 Ⓢ Icu = 50 kA	320 A	3 Pole	4221 47	46822	1
	400 A	3 Pole	4221 48	46822	1
	500 A	3 Pole	4221 49	53354	1
	630 A	3 Pole	4221 50	53354	1
	320 A	4 Pole	4221 52	57542	1
	400 A	4 Pole	4221 53	57542	1
	500 A	4 Pole	4221 54	68968	1
	630 A	4 Pole	4221 55	68968	1
DPX ³ 630 Ⓢ Icu = 70 kA	320 A	3 Pole	4221 57	55304	1
	400 A	3 Pole	4221 58	55304	1
	500 A	3 Pole	4221 59	63310	1
	630 A	3 Pole	4221 60	63310	1
	320 A	4 Pole	4221 62	68534	1
	400 A	4 Pole	4221 63	68534	1
	500 A	4 Pole	4221 64	86146	1
	630 A	4 Pole	4221 65	86146	1
DPX ³ 630 Ⓢ Icu = 100 kA	320 A	3 Pole	4221 67	■	1
	400 A	3 Pole	4221 68	■	1
	500 A	3 Pole	4221 69	■	1
	630 A	3 Pole	4221 70	■	1
	320 A	4 Pole	4221 72	■	1
	400 A	4 Pole	4221 73	■	1
	500 A	4 Pole	4221 74	■	1
	630 A	4 Pole	4221 75	■	1

MCCBs electronic release Sg with energy metering central unit

DPX ³ 630 Ⓢ Icu = 36 kA	320 A	3 Pole	4221 77	60178	1
	400 A	3 Pole	4221 78	60178	1
	500 A	3 Pole	4221 79	63704	1
	630 A	3 Pole	4221 80	63704	1
DPX ³ 630 Ⓢ	320 A	4 Pole	4221 82	69010	1
	400 A	4 Pole	4221 83	69010	1
	500 A	4 Pole	4221 84	77690	1
	630 A	4 Pole	4221 85	77690	1
DPX ³ 630 Ⓢ Icu = 50 kA	320 A	3 Pole	4221 87	63074	1
	400 A	3 Pole	4221 88	63074	1
	500 A	3 Pole	4221 89	69154	1
	630 A	3 Pole	4221 90	69154	1
	320 A	4 Pole	4221 92	73342	1
	400 A	4 Pole	4221 93	73342	1
	500 A	4 Pole	4221 94	84770	1
	630 A	4 Pole	4221 95	84770	1



4221 85

Bold Cat.Nos are products normally available with Legrand (India) Stockists. Cat.Nos that are not bold - delivery within 4 - 8 weeks from the date of order. Bold packing quantity is our mandatory packing. Orders to be placed by Legrand (India) Stockist in multiples of the same.

DPX³ 630

S2 electronic release MCCBs from 250 to 630 A

Type and frame sizes	Amps.	Poles	Cat.Nos	LP* ₹ / Unit	Pack
----------------------	-------	-------	---------	-----------------	------

MCCBs electronic release Sg with energy metering central unit

DPX ³ 630 S ² Icu = 70 kA	320 A	3 Pole	4221 97	71106	1
	400 A	3 Pole	4221 98	71106	1
	500 A	3 Pole	4221 99	79110	1
	630 A	3 Pole	4222 00	79110	1
	320 A	4 Pole	4222 02	84336	1
	400 A	4 Pole	4222 03	84336	1
	500 A	4 Pole	4222 04	101946	1
	630 A	4 Pole	4222 05	101946	1
DPX ³ 630 S ² Icu = 100 kA	320 A	3 Pole	4222 07	■	1
	400 A	3 Pole	4222 08	■	1
	500 A	3 Pole	4222 09	■	1
	630 A	3 Pole	4222 10	■	1
	320 A	4 Pole	4222 12	■	1
	400 A	4 Pole	4222 13	■	1
	500 A	4 Pole	4222 14	■	1
	630 A	4 Pole	4222 15	■	1

DPX³ 630

earth leakage modules

Earth leakage modules

Standard

DPX ³ 630 S ²	400 A	3 Pole	0260 60	72598	1
	630 A	3 Pole	0260 64	74130	1
	400 A	4 Pole	0260 61	65908	1
	630 A	4 Pole	0260 65	67102	1

LED version

DPX ³ 630 S ²	400 A	4 Pole	0260 63	92026	1
	630 A	4 Pole	0260 67	95218	1

DPX³ 1600

thermal magnetic release

MCCBs from 630 to 1250 A Ics = 100% Icu

MCCBs thermal magnetic release

DPX ³ 1600 S ² Icu = 36 kA	800 A	3 Pole	4222 52	52660	1
	1000 A	3 Pole	4222 53	63632	1
	1250 A	3 Pole	4222 54	85574	1
	800 A	4 Pole	4222 57	61438	1
	1000 A	4 Pole	4222 58	75700	1
	1250 A	4 Pole	4222 59	91060	1
	DPX ³ 1600 S ² Icu = 50 kA	800 A	3 Pole	4222 64	55548
1000 A		3 Pole	4222 65	77812	1
1250 A		3 Pole	4222 66	107656	1
	800 A	4 Pole	4222 69	69928	1
	1000 A	4 Pole	4222 70	110170	1
	1250 A	4 Pole	4222 71	120640	1

■ Price available on request.

*LP -List Price Inclusive of excise duty but exclusive of sales tax or any other taxes.

DPX³ 1600 - thermal magnetic release

MCCBs from 630 to 1250 A Ics = 100% Icu

Type and frame sizes	Amps.	Poles	Cat.Nos	LP* ₹ / Unit	Pack
----------------------	-------	-------	---------	-----------------	------

MCCBs thermal magnetic release

DPX ³ 1600 S ² Icu = 70 kA	800 A	3 Pole	4222 76	71812	1
	1000 A	3 Pole	4222 77	108746	1
	1250 A	3 Pole	4222 78	115860	1
	800 A	4 Pole	4222 81	88058	1
	1000 A	4 Pole	4222 82	153972	1
	1250 A	4 Pole	4222 83	177546	1
DPX ³ 1600 S ² Icu = 100 kA	800 A	3 Pole	4222 88	■	1
	1000 A	3 Pole	4222 89	■	1
	1250 A	3 Pole	4222 90	■	1
	800 A	4 Pole	4222 93	■	1
	1000 A	4 Pole	4222 94	■	1
	1250 A	4 Pole	4222 95	■	1

DPX³ 1600

S2 electronic release

MCCBs from 630 to 1600 A Ics = 100% Icu

MCCBs electronic release S2

DPX ³ 1600 S ² Icu = 36 kA	800 A	3 Pole	4223 00	59914	1	
	1000 A	3 Pole	4223 01	91754	1	
	1250 A	3 Pole	4223 02	110602	1	
	1600 A	3 Pole	4223 03	122904	1	
	800 A	4 Pole	4223 06	69974	1	
	1000 A	4 Pole	4223 07	135432	1	
	1250 A	4 Pole	4223 08	155746	1	
	1600 A	4 Pole	4223 09	173804	1	
	DPX ³ 1600 S ² Icu = 50 kA	800 A	3 Pole	4223 12	68632	1
1000 A		3 Pole	4223 13	90288	1	
1250 A		3 Pole	4223 14	109544	1	
	1600 A	3 Pole	4223 15	138608	1	
	800 A	4 Pole	4223 18	87524	1	
	1000 A	4 Pole	4223 19	133174	1	
	1250 A	4 Pole	4223 20	169590	1	
	1600 A	4 Pole	4223 21	195056	1	
	DPX ³ 1600 S ² Icu = 70 kA	800 A	3 Pole	4223 24	81260	1
		1000 A	3 Pole	4223 25	113876	1
		1250 A	3 Pole	4223 26	136372	1
	1600 A	3 Pole	4223 27	183320	1	
	800 A	4 Pole	4223 30	102838	1	
	1000 A	4 Pole	4223 31	162518	1	
	1250 A	4 Pole	4223 32	189604	1	
	1600 A	4 Pole	4223 33	234738	1	
	DPX ³ 1600 S ² Icu = 100 kA	800 A	3 Pole	4223 36	■	1
		1000 A	3 Pole	4223 37	■	1
		1250 A	3 Pole	4223 38	■	1
	800 A	4 Pole	4223 42	■	1	
	1000 A	4 Pole	4223 43	■	1	
	1250 A	4 Pole	4223 44	■	1	

Bold Cat.Nos are products normally available with Legrand (India) Stockists. Cat.Nos that are not bold - delivery within 4 - 8 weeks from the date of order. Bold packing quantity is our mandatory packing. Orders to be placed by Legrand (India) Stockist in multiples of the same.



4222 78



4222 83



0260 63



4223 27



4223 33

DPX³ 1600

S2 electronic release MCCBs from 630 to 1600 A

Type and frame sizes	Amps.	Poles	Cat.Nos	LP* ₹ / Unit	Pack
----------------------	-------	-------	---------	-----------------	------

MCCBs electronic release S2 with energy metering central unit

DPX ³ 1600 Icu = 36 kA	800 A	3 Pole	4223 48	77424	1
	1000 A	3 Pole	4223 49	108684	1
	1250 A	3 Pole	4223 50	127530	1
	1600 A	3 Pole	4223 51	139834	1
800 A	4 Pole	4223 54	86904	1	
	1000 A	4 Pole	4223 55	152362	1
	1250 A	4 Pole	4223 56	172676	1
	1600 A	4 Pole	4223 57	190734	1
DPX ³ 1600 Icu = 50 kA	800 A	3 Pole	4223 60	81710	1
	1000 A	3 Pole	4223 61	102704	1
	1250 A	3 Pole	4223 62	123016	1
	1600 A	3 Pole	4223 63	152362	1
800 A	4 Pole	4223 66	100784	1	
	1000 A	4 Pole	4223 67	145590	1
	1250 A	4 Pole	4223 68	182004	1
	1600 A	4 Pole	4223 69	209356	1
DPX ³ 1600 Icu = 70 kA	800 A	3 Pole	4223 72	93674	1
	1000 A	3 Pole	4223 73	126290	1
	1250 A	3 Pole	4223 74	150104	1
	1600 A	3 Pole	4223 75	197506	1
800 A	4 Pole	4223 78	116244	1	
	1000 A	4 Pole	4223 79	174934	1
	1250 A	4 Pole	4223 80	202020	1
	1600 A	4 Pole	4223 81	249420	1
DPX ³ 1600 Icu = 100 kA	800 A	3 Pole	4223 84	■	1
	1000 A	3 Pole	4223 85	■	1
	1250 A	3 Pole	4223 86	■	1
800 A	4 Pole	4223 90	■	1	
	1000 A	4 Pole	4223 91	■	1
	1250 A	4 Pole	4223 92	■	1

DPX³ 1600

Sg Microprocessor based release MCCBs from 630 to 1600 A Ics = 100% Icu

MCCBs Microprocessor based release Sg

DPX ³ 1600 Icu = 36 kA	800 A	3 Pole	4223 96	87814	1
	1000 A	3 Pole	4223 97	117938	1
	1250 A	3 Pole	4223 98	129336	1
	1600 A	3 Pole	4223 99	138028	1
800 A	4 Pole	4224 02	105074	1	
	1000 A	4 Pole	4224 03	160262	1
	1250 A	4 Pole	4224 04	180576	1
	1600 A	4 Pole	4224 05	212176	1

■ Price available on request.

*LP -List Price Inclusive of excise duty but exclusive of sales tax or any other taxes.

DPX³ 1600

Sg electronic release MCCBs from 630 to 1600 A

Type and frame sizes	Amps.	Poles	Cat.Nos	LP* ₹ / Unit	Pack
----------------------	-------	-------	---------	-----------------	------

MCCBs electronic release Sg

DPX ³ 1600 Icu = 50 kA	800 A	3 Pole	4224 08	77728	1
	1000 A	3 Pole	4224 09	99440	1
	1250 A	3 Pole	4224 10	148976	1
	1600 A	3 Pole	4224 11	178318	1
800 A	4 Pole	4224 14	100602	1	
	1000 A	4 Pole	4224 15	156492	1
	1250 A	4 Pole	4224 16	194498	1
	1600 A	4 Pole	4224 17	228590	1
DPX ³ 1600 Icu = 70 kA	800 A	3 Pole	4224 20	87796	1
	1000 A	3 Pole	4224 21	146718	1
	1250 A	3 Pole	4224 22	170756	1
	1600 A	3 Pole	4224 23	230574	1
800 A	4 Pole	4224 26	117938	1	
	1000 A	4 Pole	4224 27	199106	1
	1250 A	4 Pole	4224 28	230494	1
	1600 A	4 Pole	4224 29	271722	1
DPX ³ 1600 Icu = 100 kA	800 A	3 Pole	4224 32	■	1
	1000 A	3 Pole	4224 33	■	1
	1250 A	3 Pole	4224 34	■	1
800 A	4 Pole	4224 38	■	1	
	1000 A	4 Pole	4224 39	■	1
	1250 A	4 Pole	4224 40	■	1

MCCBs electronic release Sg with energy metering central unit

DPX ³ 1600 Icu = 36 kA	800 A	3 Pole	4224 44	105592	1
	1000 A	3 Pole	4224 45	134868	1
	1250 A	3 Pole	4224 46	146266	1
	1600 A	3 Pole	4224 47	154956	1
800 A	4 Pole	4224 50	123016	1	
	1000 A	4 Pole	4224 51	177192	1
	1250 A	4 Pole	4224 52	197506	1
	1600 A	4 Pole	4224 53	229106	1
DPX ³ 1600 Icu = 50 kA	800 A	3 Pole	4224 56	95408	1
	1000 A	3 Pole	4224 57	113944	1
	1250 A	3 Pole	4224 58	162518	1
	1600 A	3 Pole	4224 59	191862	1
800 A	4 Pole	4224 62	115118	1	
	1000 A	4 Pole	4224 63	171548	1
	1250 A	4 Pole	4224 64	209920	1
	1600 A	4 Pole	4224 65	244342	1

Bold Cat.Nos are products normally available with Legrand (India) Stockists. Cat.Nos that are not bold - delivery within 4 - 8 weeks from the date of order. Bold packing quantity is our mandatory packing. Orders to be placed by Legrand (India) Stockist in multiples of the same.

DPX³ 1600

Sg electronic release MCCBs from 630 to 1600 A

Type and frame sizes	Amps.	Poles	Cat.Nos	LP* ₹ / Unit	Pack
----------------------	-------	-------	---------	-----------------	------

MCCBs electronic release Sg with energy metering central unit

DPX ³ 1600 ④ Icu = 70 kA	800 A	3 Pole	4224 68	101338	1
	1000 A	3 Pole	4224 69	160262	1
	1250 A	3 Pole	4224 70	184300	1
	1600 A	3 Pole	4224 71	244116	1
	800 A	4 Pole	4224 74	131482	1
	1000 A	4 Pole	4224 75	212650	1
	1250 A	4 Pole	4224 76	244036	1
	1600 A	4 Pole	4224 77	285264	1
	DPX ³ 1600 ④ Icu = 100 kA	800 A	3 Pole	4224 80	■
1000 A	3 Pole	4224 81	■	1	
1250 A	3 Pole	4224 82	■	1	
	800 A	4 Pole	4224 86	■	1
	1000 A	4 Pole	4224 87	■	1
	1250 A	4 Pole	4224 88	■	1

DPX³ magnetic only

motor protection MCCBs up to 400 A

DPX³ 160

DPX ³ 160 ① Icu = 16kA	16 A	3 Pole	4207 10	11764	1
	25 A	3 Pole	4207 11	11764	1
	50 A	3 Pole	4207 12	11764	1
	63 A	3 Pole	4207 13	11764	1
DPX ³ 160 ① Icu = 25kA	16 A	3 Pole	4207 14	13070	1
	25 A	3 Pole	4207 15	13070	1
	50 A	3 Pole	4207 16	13070	1
	63 A	3 Pole	4207 17	13070	1

DPX³ 250

DPX ³ 250 ② Icu = 36 kA	100 A	3 Pole	4207 18	23524	1
	160 A	3 Pole	4207 19	23524	1
	200 A	3 Pole	4207 20	24832	1
	250 A	3 Pole	4207 21	26136	1
DPX ³ 250 ② Icu = 25 kA	100 A	3 Pole	4207 22	20908	1
	160 A	3 Pole	4207 23	20908	1
	200 A	3 Pole	4207 24	22218	1
	250 A	3 Pole	4207 25	23524	1

DPX³-I trip-free switches

160 to 1600 A

Trip free switches

DPX ³ -I 160 ①	160 A	3 Pole	4201 98	11226	1
	160 A	4 Pole	4201 99	14090	1
	160 A	4 Pole with elm	4201 97	41798	1

■ Price available on request.

*LP -List Price Inclusive of excise duty but exclusive of sales tax or any other taxes.

DPX³-I trip-free switches

160 to 1600 A

Type and frame sizes	Amps.	Poles	Cat.Nos	LP* ₹ / Unit	Pack
----------------------	-------	-------	---------	-----------------	------

Trip free switches

DPX ³ -I 250 ②	250 A	3 Pole	4202 99	25858	1
	250 A	4 Pole	4203 00	31376	1
	250 A	4 Pole with elm	4202 98	78220	1
DPX ³ -I 630 ③	400 A	3 Pole	4222 16	39276	1
	630 A	3 Pole	4222 17	44016	1
	400 A	4 Pole	4222 18	49434	1
	630 A	4 Pole	4222 19	65458	1
DPX ³ -I 1600 ④	630 A	3 Pole	4224 90	47628	1
	800 A	3 Pole	4224 91	60944	1
	1250 A	3 Pole	4224 92	72570	1
	1600 A	3 Pole	4224 93	94802	1
	630 A	4 Pole	4224 94	58688	1
	800 A	4 Pole	4224 95	76744	1
	1250 A	4 Pole	4224 96	94802	1
	1600 A	4 Pole	4224 97	133174	1



4202 99



4210 40

DPX³ 160

equipment and mounting accessories

Cat.Nos	Description	LP* ₹ / Unit	Pack
---------	-------------	-----------------	------

Equipment for plug-in version

4210 40	For DPX ³ 160 - 3P	■	1
4210 41	For DPX ³ 160 - 4P with or without earth leakage module	■	1
4210 44	Set of connectors for auxiliary contacts	■	1
4210 45	Key barrel and flat key for Padlocks	■	1
4210 46	Key barrel and star key for Padlocks	■	1
4210 47	Padlock accessory	■	1

Connection accessories

4210 26	Set of 3 terminals for High capacity cage terminals	6224	1
4210 27	Set of 4 terminals for High capacity cage terminals	8226	1
4210 70	Set of 3 insulated shields	136	1
4210 28	Set of 3 terminals Screw terminals for copper bars connection	706	1
4210 29	Set of 4 terminals Screw terminals for copper bars connection	846	1
6250 02	Set of 3 spreaders for DPX ³ 160 3P	378	1
6250 06	Set of 4 spreaders for DPX ³ 160 4P	824	1

Bold Cat.Nos are products normally available with Legrand (India) Stockists. Cat.Nos that are not bold - delivery within 4 - 8 weeks from the date of order. Bold packing quantity is our mandatory packing. Orders to be placed by Legrand (India) Stockist in multiples of the same.

DPX³ MCCB

Rotary handles for DPX³



- Smaller dimension of rotary handle base for better visibility of parameters and better access to trip unit
- Only 3 parts for easy installation
- Spring for better play
- Door defeat mechanism for easy maintenance
- ON / OFF indication on the knob
- Pad Locking on the knob – upto 3 Locks

DPX ³ MCCB selection chart									
	DPX ³	DPX ³ 160	DPX ³ 250	DPX ³ 630	DPX ³ 1600				
	Ratings	upto 160 A	40 A - 250 A	250 - 630 A	800 A	1000 A	1250 A	1600 A	
Rotary Handles	Direct	4201 60 ₹ 1538*		4201 62 ₹ 2460*		0262 61 ₹ 3278*			
	Vary Depth	4201 61 ₹ 2226*		4201 63 ₹ 4230*		0262 83 ₹ 6228*			
Motor Operator	Side	24-230 V	4210 60 ₹ 27272*	-	-	-	-	-	
		24 V			0261 40 ₹ 42792*		0261 24 ₹ 81544*		0261 19 ₹ 82398*
	Front	48 V			0261 41 ₹ 42792*		0261 25 ₹ 70358*		0261 28 ₹ 71030*
		110 V	4210 61 ₹ 24496*		-		0261 26		0261 29
		230 V			-		0261 23 ₹ 65882*		0261 27 ₹ 66512*
		230 V F			0261 44 ₹ 40068*		0261 54 ₹ 70358*		
Aux Contacts	1 NO + 1NC for RoH	4210 10 ₹ 1374*		-	-	-	-	-	
	Fault Signalling / ON-OFF			4210 11 ₹ 1072*					
Shunt Release	12 V	4210 12 ₹ 2538*		-	-	-	-	-	
	24 V	4210 13 ₹ 2538*				4222 39 ₹ 2418*			
	48 V	4210 14 ₹ 2538*				4222 40 ₹ 2418*			
	110-130 V / 110 V	4210 15 ₹ 2538*				4222 41 ₹ 2418*			
	200-277 V / 230 V	4210 16 ₹ 2538*				4222 42 ₹ 2418*			
	380-480 V / 400 V	4210 17 ₹ 2538*				4222 43 ₹ 2418*			
UV Release	12 V	4210 18 ₹ 2884*		-	-	-	-	-	
	24V DC	-	-	-		4222 44 ₹ 2860*			
	24 V	4210 19 ₹ 2884*				4222 45 ₹ 2860*			
	48 V	4210 20 ₹ 2884*				4222 46 ₹ 2860*			
	110-130 V / 110 V	4210 21 ₹ 2856*				4222 47 ₹ 2832*			
	200-240 V / 230 V	4210 22 ₹ 2856*				4222 48 ₹ 2832*			
	277 V	4210 23 ₹ 2856*		-	-	-	-	-	
	380-415 V / 400 V	4210 24 ₹ 2856*				4222 49 ₹ 2832*			
Spreaders	3P	6250 02 ₹ 378*	6250 14 ₹ 672*	6250 04 ₹ 2618*		4226 24		0262 73	
	4P	6250 06 ₹ 842*	6250 18 ₹ 1006*	6250 08 ₹ 3556*		4226 25		0262 74	

■ Price available on request.

*LP -List Price Inclusive of excise duty but exclusive of sales tax or any other taxes.

Bold Cat.Nos are products normally available with Legrand (India) Stockists. Cat.Nos that are not bold - delivery within 4 - 8 weeks from the date of order. Bold packing quantity is our mandatory packing. Orders to be placed by Legrand (India) Stockist in multiples of the same.

DPX³ 160 equipment and mounting accessories



4210 36

Cat.Nos	Description	LP* ₹ / Unit	Pack
---------	-------------	--------------------	------

Connection accessories

4210 36	Set of 3 rear terminals for DPX ³ 160 3P	5822	1
4210 37	Set of 4 rear terminals for DPX ³ 160 4P	7814	1

Sealable terminal shields

For front terminals

4210 54	For DPX ³ 160 3P	6362	1
4210 55	For DPX ³ 160 3P	6718	1

For rear terminals

4210 50	For DPX ³ 160 3P	4020	1
4210 51	For DPX ³ 160 4P	3574	1

Fixing plates

4210 71	For DPX ³ 160 3P / 4P without earth leakage module	332	1
4210 73	For DPX ³ 160 4P with earth leakage module	814	1
4210 68	For DPX ³ 160 3P / 4P with side mounting motor operator	1480	1

DPX³ 160 and 250 common auxiliaries and accessories



4210 58

Supply inverter type

4210 58	For fixed version	5368	1
4210 59	For plug-in and draw-out version	5722	1

Rotary handles

4201 60	Standard handle for thermal magnetic DPX ³	1538	1
4201 61	Vari-depth standard handles	2226	1
4201 67	Key Lock for VD RH DPX ³ 160 & 250	■	1
4201 65	Key Lock for DIR RH Type A DPX ³ 160 & 250	■	1
4201 68	Key Lock for VD RH Type A DPX ³ 160 & 250	■	1
4201 66	Key Lock for DIR RH Type B DPX ³ 160 & 250	■	1
4201 69	Key Lock for VD RH Type B DPX ³ 160 & 250	■	1

Motor-driven handles

4210 60	Side motor operator	27272	1
4210 61	Front motor operator	24496	1
4210 62	Ronis key barrel for front motor operator	9794	1
4210 63	Profalux key barrel for front motor operator	23268	1

■ Price available on request.

*LP -List Price Inclusive of excise duty but exclusive of sales tax or any other taxes.

Red Cat.Nos - new products

DPX³ 160 and 250 common auxiliaries and accessories

Cat.Nos	Description	LP* ₹ / Unit	Pack
---------	-------------	--------------------	------

Motor-driven handles

4210 64	Padlock for front motor operator	3320	1
4210 65	Ronis key barrel for side motor operator	25834	1
4210 66	Profalux key barrel for side motor operator	23476	1
4210 67	Padlock for side motor operator	3528	1

Auxiliary contacts

4210 10	1 N/C + 1 N/O auxiliary contact for rotary handles	1374	1
4210 11	Auxiliary contact or fault signalling contact	1072	1
4210 48	Signalling contact plugged-in/drawn-out (for DPX ³ plug-in version)	■	1



4210 10



4210 11



4210 16



4210 22

Shunt releases

4210 12	12 V~	2538	1
4210 13	24 V~	2538	1
4210 14	48 V~	2538	1
4210 15	110-130 V~	2538	1
4210 16	200-277 V~	2538	1
4210 17	380-480 V~	2538	1

Undervoltage releases

4210 18	12 V~	2884	1
4210 19	24 V~	2884	1
4210 20	48 V~	2884	1
4210 21	110-130 V~	2856	1
4210 22	200-240 V~	2856	1
4210 23	277 V~	2856	1
4210 24	380-415 V~	2856	1
4210 25	440-480 V~	2856	1

Locking accessory

4210 49	Padlock for locking in "open" position	1672	1
---------	--	------	---

Communication interface

4210 75	Modbus	20702	1
---------	--------	-------	---

DPX³ 250 equipment and mounting accessories

Equipment for plug-in version

4210 42	For DPX ³ 250 - 3P	■	1
4210 43	For DPX ³ 250 - 4P with or without earth leakage module	■	1
4210 44	Set of connectors for auxiliary contacts	■	1
4210 45	Key barrel and flat key N° ABA90GEL6149 for Padlocks	■	1
4210 46	Key barrel and star key N° HBA90GPS6149 for Padlocks	■	1
4210 47	Padlock accessory	■	1



4210 44

Connection accessories

4210 30	Set of 3 cage terminals	2508	1
4210 31	Set of 4 cage terminals	3266	1
4210 70	Set of 3 insulated shields	136	1



4210 31

Bold Cat.Nos are products normally available with Legrand (India) Stockists. Cat.Nos that are not bold - delivery within 4 - 8 weeks from the date of order. Bold packing quantity is our mandatory packing. Orders to be placed by Legrand (India) Stockist in multiples of the same.

DPX³ 250

equipment and mounting accessories

Cat.Nos	Description	LP* ₹ / Unit	Pack
---------	-------------	--------------------	------

Connection accessories

6250 14	Set of 3 spreaders for DPX ³ 250 3P	672	1
6250 18	Set of 4 spreaders for DPX ³ 250 4P	1006	1
4210 38	Set of 3 rear terminals for DPX ³ 250 3P	5296	1
4210 39	Set of 4 rear terminals for DPX ³ 250 4P	7130	1

Sealable terminal shields

For front terminals

4210 56	For DPX ³ 250 3P	6588	1
4210 57	For DPX ³ 250 4P	6974	1

For rear terminals

4210 52	For DPX ³ 250 3P	3928	1
4210 53	For DPX ³ 250 4P	4318	1

Fixing plates

4210 72	For DPX ³ 250 3P / 4P without earth leakage module	332	1
4210 74	For DPX ³ 250 4P with earth leakage module	1404	1
4210 69	For DPX ³ 250 3P / 4P with side mounting motor operator	1456	1



4210 72

DPX³ 630

equipment and accessories

Plug-in version

4222 20	Set of incoming and outgoing terminals - 3P (6 terminals for 3P DPX ³ or 8 terminals for 4P DPX ³)	■	1
4222 21	Set of incoming and outgoing terminals - 4P (6 terminals for 3P DPX ³ or 8 terminals for 4P DPX ³)	■	1
4222 22	Front terminal mounting base for DPX ³ only - 3P	■	1
4222 24	Flat rear terminal mounting base for DPX ³ only - 3P	■	1
4222 23	Front terminal mounting base for DPX ³ only - 4P	■	1
4222 25	Flat rear terminal mounting base for DPX ³ only - 4P	■	1
4222 26	Front terminal mounting base for DPX ³ with earth leakage module - 4 P	■	1
4222 27	Flat rear terminal mounting base for DPX ³ with earth leakage module - 4P	■	1
4222 37	For fixing the signalling contact - 4P Cat.No 0265 74 on a DPX ³ plug-in version	■	1
4222 28	Set of 2 extractor handle	■	1
4222 29	Set of connectors (24-pin)	■	1

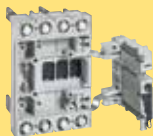

4222 25

■ Price available on request.

*LP -List Price Inclusive of excise duty but exclusive of sales tax or any other taxes.

Red Cat.Nos - new products

DPX³ 630

equipment and accessories

Cat.Nos	Description	LP* ₹ / Unit	Pack
---------	-------------	--------------------	------

Draw-out version

4222 31	"Debro-lift" mechanism for DPX ³ base only - 3P	■	1
4222 32	"Debro-lift" mechanism for DPX ³ base only - 4P	■	1
4222 33	"Debro-lift" mechanism for DPX ³ base with elm - 4P	■	1
0265 76	One key for "Debro-lift" mechanism for DPX ³ only - Flat key	■	1
0265 78	Two keys (one key supplied) for "Debro-lift" mechanism for motorised DPX ³ or with rotary handle - Flat key	■	1
0263 48	One key for "Debro-lift" mechanism for DPX ³ only - Star key	■	1
0265 77	Two keys (one key supplied) for motorised DPX ³ or with rotary handle - Star key	■	1
0265 75	Handle for drawing-out for "Debro-lift" mechanism	■	1
0265 74	Signalling contact (plugged-in/drawn-out) for "Debro-lift" mechanism	■	1
4222 36	For fixing the signalling contact Cat.No 0265 74 on a DPX ³ draw-out version	■	1
4222 30	Block of 6 automatic auxiliary contacts for DPX ³ draw-out version (up to 2 blocks by DPX ³)	■	1



4222 32

Supply inverter type

0264 09	Plate for MCCB or trip-free switch fixed version	8042	1
0264 04	Plate for MCCB or trip-free switch plug-in and draw-out version	16666	1

Rotary handles

4201 62	Direct rotary handle	2460	1
4201 63	Vari-depth rotary handle	4230	1
4201 70	Key Lock for VD RH DPX3 630	■	1
4201 71	Key Lock for VD RH Type A DPX ³ 630	■	1
4201 72	Key Lock for VD RH Type B DPX ³ 630	■	1

Motor-driven handles

0261 40	Front operated 24 V~	42792	1
0261 41	Front operated 48 V~	42792	1
0261 44	Front operated 230 V~	40068	1
0261 59	Lock and flat key	13506	1
0261 58	Lock and star key	14718	1



0261 40

Accessories

0262 30	Set of 3 Insulated shields	170	1
0262 44	Set of 2 sealable terminal shields - 3P	5006	1
0262 45	Set of 2 sealable terminal shields - 4P	4958	1

Bold Cat.Nos are products normally available with Legrand (India) Stockists. Cat.Nos that are not bold - delivery within 4 - 8 weeks from the date of order. Bold packing quantity is our mandatory packing. Orders to be placed by Legrand (India) Stockist in multiples of the same.

DPX³ 630 equipment and accessories

Cat.Nos	Description	LP* ₹ / Unit	Pack
---------	-------------	--------------------	------

Accessories

0262 40	Padlock for locking in "OPEN" position - 4P	1688	1
0262 46	Set of 4 adaptors + insulated shields for lug - 4P	7286	1
0262 47	Set of 4 extended front terminals - 4P	10522	1
6250 04	Set of incoming or outgoing spreaders - 3P	2618	1
6250 08	Set of incoming or outgoing spreaders - 4P	3556	1
0263 50	Set of incoming or outgoing swivel rear terminals - 3P	29142	1
0263 52	Set of incoming or outgoing flat rear terminals - 3P	34882	1
0263 51	Set of incoming or outgoing swivel terminals - 4P	38562	1
0263 53	Set of incoming or outgoing flat terminals - 4P	■	1
4222 34	Set of 2 IP 20 terminal covers - 3P	■	1
4222 35	Set of 2 IP 20 terminal covers - 4P	■	1



6250 04



4222 34



4222 35

DPX³ 1600 equipment and accessories

Draw-out version

4225 86	Front terminals - 3P	■	1
4225 88	Rear terminals - 3P	■	1
4225 87	Front terminals - 4P	■	1
4225 89	Rear terminals - 4P	■	1
4225 93	Debro-lift mechanism for DPX ³ 1600 - 3P	■	1
4225 94	Debro-lift mechanism for DPX ³ 1600 - 4P	■	1
4225 95	For fixing the signalling contact Cat.No 0265 74 on a DPX ³ draw-out version	■	1
0265 76	One key for "Debro-lift" mechanism for DPX ³ only - Flat key	■	1
0265 80	Two key (one key supplied) for motorised DPX ³ or with rotary handle	■	1
0263 48	One key for DPX ³ only - Starkey	■	1
0265 79	Two key (one key supplied) for motorised DPX ³ or with rotary handle	■	1
0265 75	Handle for drawing-out for "Debro-lift" mechanism	■	1
0265 74	Signalling contact (plugged-in/drawn-out)	■	1
4222 30	Block of 6 automatic auxiliary contacts for DPX ³ draw-out version (up to 2 blocks by DPX ³)	■	1

4225 88
+
4225 93

Supply inverter type

0264 10	Plate for MCCBs or trip-free switch fixed version	10166	1
0264 05	Plate for MCCBs or trip-free switch plug-in and draw-out version	18022	1

■ Price available on request.

*LP - List Price Inclusive of excise duty but exclusive of sales tax or any other taxes.

Red Cat.Nos - new products

DPX³ 1600 equipment and accessories

Cat.Nos	Description	LP* ₹ / Unit	Pack
---------	-------------	--------------------	------

Rotary handles

0262 61	Standard (black) direct on DPX ³	3278	1
0262 83	Standard (black) vari-depth handle IP 55	6228	1
0262 93	Key barrel and flat key	13506	1
0262 94	Key barrel and star key	10502	1

Motor-driven handles

0261 54	Front operated 230 V~	70358	1
0261 24	Front operated 24 V~/= for In ≤ 1250 A	81544	1
0261 25	Front operated 48 V~/= for In ≤ 1250 A	70358	1

Motor-driven handles

0261 26	Front operated 110 V~/= for In ≤ 1250 A	■	1
0261 23	Front operated 230 V~/= for In ≤ 1250 A	65882	1
0261 19	Front operated 24 V~/= for In = 1600 A	82398	1
0261 28	Front operated 48 V~/= for In = 1600 A	71030	1
0261 29	Front operated 110 V~/= for In = 1600 A	■	1
0261 27	Front operated 230 V~/= for In = 1600 A	66512	1
0261 59	Key and flat key	13506	1
0261 58	Key and star key	14718	1

Accessories

0262 66	Set of 3 insulated shields	324	1
0262 64	Set of 2 sealable terminal shields - 3P	8242	1
0262 65	Set of 2 sealable terminal shields - 4P	8536	1
0262 60	Padlock for locking in "open" position	1952	1
0262 67	Set of 4 extended front short terminals for 630 - 1250 A (2 bars max. per pole)	10008	1
0262 68	Set of 4 extended front Long terminals for 1600 A (3 bars max. per pole)	18694	1
4226 24	Set of incoming or outgoing spreaders for 800 A & 1000 A - 3P	■	1
4226 25	Set of incoming or outgoing spreaders for 800 A & 1000 A - 4P	■	1
0262 73	Set of incoming or outgoing spreaders for 1250 A & 1600 A - 3P	■	1
0262 74	Set of incoming or outgoing spreaders for 1250 A & 1600 A - 4P	■	1
0263 80	Short rear terminals - 3P	■	1
0263 81	Long rear terminals - 3P	■	1
0263 82	Short rear terminals - 4P	■	1
0263 83	Long rear terminals - 4P	■	1
4225 90	Set of 2 IP 20 terminal covers - 3P	1354	1
4225 91	Set of 2 IP 20 terminal covers - 4P	2030	1
4225 92	External neutral - 4P	■	1



0262 60

0262 67
+
0262 68

Bold Cat.Nos are products normally available with Legrand (India) Stockists. Cat.Nos that are not bold - delivery within 4 - 8 weeks from the date of order. Bold packing quantity is our mandatory packing. Orders to be placed by Legrand (India) Stockist in multiples of the same.

DPX³ 630 and 1600 common auxiliaries

Cat.Nos	Description	LP* ₹ / Unit	Pack
---------	-------------	--------------------	------

Common auxiliaries

4210 11	For signalling the state of the contacts or opening of the MCCB on a fault For DPX ³ /DPX ³ -I Changeover switch 3 A - 240 V~	1072	1
---------	--	------	---

Releases

Allow remote tripping of a DPX³

Shunt releases

For DPX³ and DPX³-I

Shunt inrush power 300 VA

4222 39	Coil voltage 24 V~/=	2418	1
4222 40	Coil voltage 48 V~/=	2418	1
4222 41	Coil voltage 110 V~/=	2418	1
4222 42	Coil voltage 230 V~/=	2418	1
4222 43	Coil voltage 400 V~/=	2418	1

Undervoltage releases

For DPX³ and DPX³-I

Shunt inrush power 300 VA

4222 44	Coil voltage 24 V=	2860	1
4222 45	Coil voltage 24 V~	2860	1
4222 46	Coil voltage 48 V~/=	2860	1
4222 47	Coil voltage 110 V~/=	2832	1
4222 48	Coil voltage 230 V~/=	2832	1
4222 49	Coil voltage 400 V~/=	2832	1

Time-lag undervoltage releases (800 ms)

Prevent false tripping in the event of power supply microbreaks.

Require a time-lag module connected to the undervoltage release Cat.No 4226 23

0261 90	Time-lag module 230 V~ 3 module	20606	1
0261 91	Time-lag module 400 V~ 3 module	22928	1
4226 23	Undervoltage release for DPX ³ 630 and 1600	■	1

Automation control unit

4226 80	Standard unit	72978	1
4226 82	Advanced unit	79616	1
4226 89	Communication module	20702	1



4226 82

DPX³ 160, 250, 630 and 1600 power supervision system

Auxiliary power supply for DPX³

4210 83	Input voltage 24 V~/=	■	1
---------	-----------------------	---	---

RS485 Modbus communication interface

4210 75	DPX ³ electronic interface for connecting thermal-magnetic DPX ³ with residual current protection and electronic DPX ³ to an RS485 Modbus	■	1
---------	--	---	---

Modular power supply

0035 67	230 V~ - 27 V~- - 0.6 A 2 modules	■	1
---------	--------------------------------------	---	---

■ Price available on request.

*LP -List Price Inclusive of excise duty but exclusive of sales tax or any other taxes.

❖ For Cat.Nos. and further details please contact th nearest branch.

Red Cat.Nos - new products

DPX³ 160, 250, 630 and 1600 power supervision system

Cat.Nos	Description	LP* ₹ / Unit	Pack
---------	-------------	--------------------	------

Communication and supervision

0261 78	Web servers for 32 metering points (meters or multi-function measuring units)	■	1
0261 79	Web servers for an unlimited number of metering points (meters or multi-function measuring units)	■	1
0261 88	Legrand Software For 32 metering points (supplied on CD)	■	1
0261 89	Legrand Software For an unlimited number of metering points (supplied on CD)	■	1



0261 78

Panel board display

0261 56	Allows to chek information coming from different protection devices: DX ³ -HP, DPX ³ , DMX ³ or EMDX ³	19938	1
---------	--	-------	---



0261 56

Residual current relay

0260 88	Residual current relay to clip on module 2 rail	19236	1
---------	---	-------	---



0260 88

Coils

0260 92	Coil Ø35 mm	■	1
0260 93	Coil Ø80 mm	■	1
0260 94	Coil Ø110 mm	■	1
0260 95	Coil Ø140 mm	■	1
0260 96	Coil Ø210 mm	■	1
0260 97	Coil Ø150 mm - open	■	1
0260 98	Coil Ø300 mm - open	■	1



0260 93
coil for use
with relay



0260 98

Residual current relay and coils

Measurement and control of electric equipment

0261 35	Central position	■	1/2
0261 37	Microprocessor interface	■	1/3
0261 36	Interface signaling and control	■	1/2
0261 45	Kit configurator	■	1/4
0466 23	Stabilized power	■	1/20



0261 37

DPX³ automatic transfer switch

DPX³ ready-to-install ATS kit without MCCBs

6253 80*	Ready to use assembly for DPX ³ 160	255240	1
6253 81*	Ready to use assembly for DPX ³ 160 & DPX ³ 250	255240	1
6253 82*	Ready to use assembly for DPX ³ 250	277930	1
6253 87*	Ready to use assembly for DPX ³ 630	305594	1
6253 93	Kit assembly for ATS for DPX ³ 160	17468	1
6253 94	Kit assembly for ATS for DPX ³ 250	22054	1
6253 95	Kit assembly for ATS for DPX ³ 630	28934	1



6253 93

Bold Cat.Nos are products normally available with Legrand (India) Stockists. Cat.Nos that are not bold - delivery within 4 - 8 weeks from the date of order. Bold packing quantity is our mandatory packing. Orders to be placed by Legrand (India) Stockist in multiples of the same.

Mini contactors CTX³ 6 to 16 A industrial contactors

NEW!



4170 00



4170 01

Cat.Nos	Max. opt. current AC 3	Control voltage	MRP* ₹ / Unit	Pack
---------	------------------------	-----------------	---------------	------

3 pole mini contactors

With integrated auxiliary contact
Power terminals: screw terminals

6 A - Integrated auxiliary contact 1 NO

4170 00	6 A	24 V~	916	1
4170 01	6 A	24 V=	1376	1
4170 04	6 A	110 V~	916	1
4170 06	6 A	230 V~	916	1
4170 09	6 A	415 V~	916	1

6 A - Integrated auxiliary contact 1 NC

4170 10	6 A	24 V~	916	1
4170 11	6 A	24 V=	1376	1
4170 14	6 A	110 V~	916	1
4170 16	6 A	230 V~	916	1
4170 19	6 A	415 V~	916	1

9 A - Integrated auxiliary contact 1 NO

4170 20	9 A	24 V~	1004	1
4170 21	9 A	24 V=	1462	1
4170 24	9 A	110 V~	1004	1
4170 26	9 A	230 V~	1004	1
4170 29	9 A	415 V~	1004	1

9 A - Integrated auxiliary contact 1 NC

4170 30	9 A	24 V~	1004	1
4170 31	9 A	24 V=	1462	1
4170 34	9 A	110 V~	1004	1
4170 36	9 A	230 V~	1004	1
4170 39	9 A	415 V~	1004	1

12 A - Integrated auxiliary contact 1 NO

4170 40	12 A	24 V~	1092	1
4170 41	12 A	24 V=	1790	1
4170 44	12 A	110 V~	1092	1
4170 46	12 A	230 V~	1092	1
4170 49	12 A	415 V~	1092	1

12 A - Integrated auxiliary contact 1 NC

4170 50	12 A	24 V~	1092	1
4170 51	12 A	24 V=	1790	1
4170 54	12 A	110 V~	1092	1
4170 56	12 A	230 V~	1092	1
4170 59	12 A	415 V~	1092	1

16 A - Integrated auxiliary contact 1 NO

4170 60	16 A	24 V~	1310	1
4170 61	16 A	24 V=	2074	1
4170 64	16 A	110 V~	1310	1
4170 66	16 A	230 V~	1310	1
4170 69	16 A	415 V~	1310	1

16 A - Integrated auxiliary contact 1 NC

4170 70	16 A	24 V~	1310	1
4170 71	16 A	24 V=	2074	1
4170 74	16 A	110 V~	1310	1
4170 76	16 A	230 V~	1310	1
4170 79	16 A	415 V~	1310	1

4-pole mini contactors

Without integrated auxiliary contact
Power terminals: screw terminals

Cat.Nos	Max. opt. current AC 1	Max. opt. current AC 3	Control voltage	MRP* ₹ / Unit	Pack
---------	------------------------	------------------------	-----------------	---------------	------

20 A

4171 40	20 A	16 A	24 V~	1004	1
4171 41	20 A	16 A	24 V=	1638	1
4171 44	20 A	16 A	110 V~	1004	1
4171 46	20 A	16 A	230 V~	1004	1
4171 49	20 A	16 A	415 V~	1004	1

* MRP - Maximum Retail Price Inclusive of all taxes.
Red Cat.Nos - new products

NEW!



4170 88



4171 55

Thermal relays and accessories for mini contactors

Cat.Nos	Description	MRP* ₹ / Unit	Pack
---------	-------------	---------------	------

Thermal overload relays for 3 pole mini contactors

Class 10A - Integrated auxiliary contacts 1 NO + 1 NC

4170 80	0.16 A	1048	1
4170 81	0.25 A	1048	1
4170 82	0.40 A	1048	1
4170 83	0.63 A	1048	1
4170 84	1 A	1048	1
4170 85	1.6 A	1048	1
4170 86	2.5 A	1048	1
4170 87	4 A	1048	1
4170 88	6 A	1048	1
4170 89	8 A	1048	1
4170 90	9 A	1048	1
4170 91	10 A	1048	1
4170 92	13 A	1048	1
4170 93	16 A	1048	1

Add on auxiliary blocks for mini contactors

Ith : 10 A

Front mounting

4171 50	1 NO + 1 NC	284	15
4171 51	2 NO	284	15
4171 52	2 NC	284	15
4171 53	4 NO	436	15
4171 54	3 NO + 1 NC	436	15
4171 55	2 NO + 2 NC	436	15
4171 56	1 NO + 3 NC	436	15
4171 57	4 NC	436	15

Side mounting

4171 58	1 NO	284	20
4171 59	1 NC	284	20

Interlock Unit

4171 60	Mechanical interlock for mini contactors	458	5
---------	--	-----	---

Spare coils

4171 70	24 V~	546	10
4171 71	24 V=	742	10
4171 74	110 V~	546	10
4171 76	230 V~	546	10
4171 79	415 V~	546	10

3-pole contactors CTX³

9 A to 100 A industrial contactors

Cat.Nos	Max. opt. current AC 3	Control voltage	MRP* ₹ / Unit	Pack
---------	------------------------	-----------------	---------------	------

CTX³ 22

With integrated auxiliary contacts
Power terminals: screw terminals

9 A - Integrated auxiliary contacts 1 NO + 1 NC

4160 80	9 A	24 V~	952	1
4160 81	9 A	24 V=	1818	1
4160 82	9 A	48 V~	952	1
4160 83	9 A	48 V=	1818	1
4160 84	9 A	110 V~	952	1
4160 86	9 A	230 V~	952	1
4160 88	9 A	380 V~	952	1
4160 89	9 A	415 V~	952	1

12 A - Integrated auxiliary contacts 1 NO + 1 NC

4160 90	12 A	24 V~	1060	1
4160 91	12 A	24 V=	1962	1
4160 92	12 A	48 V~	1060	1

Bold Cat.Nos are products normally available with Legrand (India) Stockists.
Cat.Nos that are not bold - delivery within 4 - 8 weeks from the date of order.
Bold packing quantity is our mandatory packing. Orders to be placed by Legrand (India) Stockist in multiples of the same.

3 pole contactors CTX³ 9 A to 100 A industrial contactors

NEW!



4160 96

Cat.Nos	Max. opt. current AC 3	Control voltage	MRP* ₹ / Unit	Pack
---------	------------------------	-----------------	---------------	------

12 A - Integrated auxiliary contacts 1 NO + 1 NC

4160 93	12 A	48 V~	1962	1
4160 94	12 A	110 V~	1060	1
4160 96	12 A	230 V~	1060	1
4160 98	12 A	380 V~	1060	1
4160 99	12 A	415 V~	1060	1

18 A - Integrated auxiliary contacts 1 NO + 1 NC

4161 00	18 A	24 V~	1210	1
4161 01	18 A	24 V=	2424	1
4161 02	18 A	48 V~	1210	1
4161 03	18 A	48 V=	2424	1
4161 04	18 A	110 V~	1210	1
4161 06	18 A	230 V~	1210	1
4161 08	18 A	380 V~	1210	1
4161 09	18 A	415 V~	1210	1

22 A - Integrated auxiliary contacts 1 NO + 1 NC

4161 10	22 A	24 V~	1730	1
4161 11	22 A	24 V=	3304	1
4161 12	22 A	48 V~	1730	1
4161 13	22 A	48 V=	3304	1
4161 14	22 A	110 V~	1730	1
4161 16	22 A	230 V~	1730	1
4161 18	22 A	380 V~	1730	1
4161 19	22 A	415 V~	1730	1

CTX³ 40

With integrated auxiliary contacts
Power terminals: screw terminals



4161 26

32 A - Integrated auxiliary contacts 2 NO + 2 NC

4161 20	32 A	24 V~	3460	1
4161 21	32 A	24 V=	6940	1
4161 22	32 A	48 V~	3460	1
4161 23	32 A	48 V=	6940	1
4161 24	32 A	110 V~	3460	1
4161 26	32 A	230 V~	3460	1
4161 28	32 A	380 V~	3460	1
4161 29	32 A	415 V~	3460	1

40 A - Integrated auxiliary contacts 2 NO + 2 NC

4161 30	40 A	24 V~	5448	1
4161 31	40 A	24 V=	9254	1
4161 32	40 A	48 V~	5448	1
4161 33	40 A	48 V=	9254	1
4161 34	40 A	110 V~	5448	1
4161 36	40 A	230 V~	5448	1
4161 38	40 A	380 V~	5448	1
4161 39	40 A	415 V~	5448	1

CTX³ 65

With integrated auxiliary contacts



4161 46

50 A - Integrated auxiliary contacts 2 NO + 2 NC
Screw terminals

4161 40	50 A	24 V~	6766	1
4161 41	50 A	24 V=	11236	1
4161 42	50 A	48 V~	6766	1
4161 43	50 A	48 V=	11236	1
4161 44	50 A	110 V~	6766	1
4161 46	50 A	230 V~	6766	1
4161 48	50 A	380 V~	6766	1
4161 49	50 A	415 V~	6766	1

50 A - Integrated auxiliary contacts 2 NO + 2 NC
Cage terminals



4161 56

4161 50	50 A	24 V~	6766	1
4161 51	50 A	24 V=	11236	1
4161 52	50 A	48 V~	6766	1
4161 53	50 A	48 V=	11236	1
4161 54	50 A	110 V~	6766	1
4161 56	50 A	230 V~	6766	1
4161 58	50 A	380 V~	6766	1
4161 59	50 A	415 V~	6766	1

* MRP - Maximum Retail Price Inclusive of all taxes.
Red Cat.Nos - new products

3 pole contactors CTX³ 9 A to 100 A industrial contactors

NEW!

Cat.Nos	Max. opt. current AC 3	Control voltage	MRP* ₹ / Unit	Pack
---------	------------------------	-----------------	---------------	------

65 A - Integrated auxiliary contacts 2 NO + 2 NC
Screw terminals

4161 60	65 A	24 V~	9168	1
4161 61	65 A	24 V=	12998	1
4161 62	65 A	48 V~	9168	1
4161 63	65 A	48 V=	12998	1
4161 64	65 A	110 V~	9168	1
4161 66	65 A	230 V~	9168	1
4161 68	65 A	380 V~	9168	1
4161 69	65 A	415 V~	9168	1

65 A - Integrated auxiliary contacts 2 NO + 2 NC
Cage terminals

4161 70	65 A	24 V~	9168	1
4161 71	65 A	24 V=	12998	1
4161 72	65 A	48 V~	9138	1
4161 73	65 A	48 V=	12998	1
4161 74	65 A	110 V~	9168	1
4161 76	65 A	230 V~	9168	1
4161 78	65 A	380 V~	9168	1
4161 79	65 A	415 V~	9168	1

3 pole contactors CTX³ 130 A to 800 A industrial contactors

CTX³ 100

With integrated auxiliary contacts



4161 86

75 A - Integrated auxiliary contacts 2 NO + 2 NC
Screw terminals

4161 80	75 A	24 V~	11896	1
4161 81	75 A	24 V=	15974	1
4161 82	75 A	48 V~	11896	1
4161 83	75 A	48 V=	15974	1
4161 84	75 A	110 V~	11896	1
4161 86	75 A	230 V~	11896	1
4161 88	75 A	380 V~	11896	1
4161 89	75 A	415 V~	11896	1

75 A - Integrated auxiliary contacts 2 NO + 2 NC
Cage terminals

4161 90	75 A	24 V~	11896	1
4161 91	75 A	24 V=	15974	1
4161 92	75 A	48 V~	11896	1
4161 93	75 A	48 V=	15974	1
4161 94	75 A	110 V~	11896	1
4161 96	75 A	230 V~	11896	1
4161 98	75 A	380 V~	11896	1
4161 99	75 A	415 V~	11896	1

85 A - Integrated auxiliary contacts 2 NO + 2 NC
Screw terminals

4162 00	85 A	24 V~	11896	1
4162 01	85 A	24 V=	15974	1
4162 02	85 A	48 V~	11896	1
4162 03	85 A	48 V=	15974	1
4162 04	85 A	110 V~	11896	1
4162 06	85 A	230 V~	11896	1
4162 08	85 A	380 V~	11896	1
4162 09	85 A	415 V~	11896	1

85 A - Integrated auxiliary contacts 2 NO + 2 NC
Cage terminals

4162 10	85 A	24 V~	11896	1
4162 11	85 A	24 V=	15974	1
4162 12	85 A	48 V~	11896	1
4162 13	85 A	48 V=	15974	1
4162 14	85 A	110 V~	11896	1
4162 16	85 A	230 V~	11896	1
4162 18	85 A	380 V~	11896	1
4162 19	85 A	415 V~	11896	1

Bold Cat.Nos are products normally available with Legrand (India) Stockists.
Cat.Nos that are not bold - delivery within 4 - 8 weeks from the date of order.
Bold packing quantity is our mandatory packing. Orders to be placed by Legrand (India) Stockist in multiples of the same.

Thermal relays RTX³ for CTX³ 3 pole industrial contactors

NEW!

Cat.Nos	I min. (A)	I max. (A)	MRP* ₹ / Unit	Pack
---------	---------------	---------------	---------------------	------

RTX³ 40 - for CTX³ 22 and 40
Standard type with screw terminals

4166 50	6	9	1488	1
4166 51	7	10	1488	1
4166 52	9	13	1488	1
4166 53	12	18	1488	1
4166 54	16	22	1488	1
4166 55	18	25	1488	1
4166 56	22	32	1488	1
4166 57	28	40	1488	1

RTX³ 40 - for CTX³ 22 and 40
Differential type with screw terminals

4166 60	0.1	0.16	1784	1
4166 61	0.16	0.25	1784	1
4166 62	0.25	0.4	1784	1
4166 63	0.4	0.63	1784	1
4166 64	0.63	1	1784	1
4166 65	1	1.6	1784	1
4166 66	1.6	2.5	1784	1
4166 67	2.5	4	1784	1
4166 68	4	6	1784	1
4166 69	5	8	1784	1
4166 70	6	9	1784	1
4166 71	7	10	1784	1
4166 72	9	13	1784	1
4166 73	12	18	1784	1
4166 74	16	22	1784	1
4166 75	18	25	1784	1
4166 76	22	32	1784	1
4166 77	28	40	1784	1



4166 70

RTX³ 65 - for CTX³ 65
Standard type with screw terminals

4166 83	9	13	2964	1
4166 84	12	18	2964	1
4166 85	16	22	2964	1
4166 86	18	25	2964	1
4166 87	24	36	2964	1
4166 88	28	40	2964	1
4166 89	34	50	2964	1
4166 90	45	65	2964	1



4166 90

RTX³ 65 - for CTX³ 65
Differential type with cage terminals

4167 03	9	13	3556	1
4167 04	12	18	3556	1
4167 05	16	22	3556	1
4167 06	18	25	3556	1
4167 07	24	36	3556	1
4167 08	28	40	3556	1
4167 09	34	50	3556	1
4167 10	45	65	3556	1

RTX³ 100 - for CTX³ 100
Standard type with screw terminals

4167 23	18	25	4626	1
4167 24	24	36	4626	1
4167 25	28	40	4626	1
4167 26	34	50	4626	1
4167 27	45	65	4626	1
4167 28	54	75	4626	1
4167 29	63	85	4626	1
4167 30	70	95	4626	1
4167 31	80	100	4626	1



4167 31

RTX³ 100 - for CTX³ 100
Differential type with cage terminals

4167 43	18	25	5552	1
4167 44	24	36	5552	1
4167 45	28	40	5552	1
4167 46	34	50	5552	1
4167 47	45	65	5552	1
4167 48	54	75	5552	1

* MRP - Maximum Retail Price Inclusive of all taxes.
Red Cat.Nos - new products

Thermal relays RTX³ for CTX³ 3 pole industrial contactors

NEW!

Cat.Nos	I min. (A)	I max. (A)	MRP* ₹ / Unit	Pack
---------	---------------	---------------	---------------------	------

RTX³ 100 - for CTX³ 100
Differential type with cage terminals

4167 49	63	85	5552	1
4167 50	70	95	5552	1
4167 51	80	100	5552	1

RTX³ 150 - for CTX³ 150
Standard type with screw terminals

4167 60	45	65	6390	1
4167 61	54	75	6390	1
4167 62	63	85	6390	1
4167 63	80	105	6390	1
4167 64	95	130	6390	1
4167 65	110	150	6390	1



4167 65

RTX³ 150 - for CTX³ 150
Differential type with cage terminals

4167 70	45	65	7818	1
4167 71	54	75	7818	1
4167 72	63	85	7818	1
4167 73	80	105	7818	1
4167 74	95	130	7818	1
4167 75	110	150	7818	1

Separate mounting units

To mount the relays separately from contactors,
on DIN rail or panel by fixing screws

Cat.Nos	Description	MRP* ₹ / Unit	Pack
---------	-------------	---------------------	------

4165 91	For RTX ³ 40 up to 32 A	572	1
4165 92	For RTX ³ 40 40 A	572	1
4165 93	For RTX ³ 65 with screw terminals	704	1
4165 94	For RTX ³ 65 with cage terminals	704	1
4165 95	For RTX ³ 100 with screw terminals	902	1
4165 96	For RTX ³ 100 with cage terminals	902	1
4165 97	For RTX ³ 150 with screw terminals	1438	1
4165 98	For RTX ³ 150 with cage terminals	1438	1

Thermal overload relays

Class 10 A - Integrated auxiliary contacts 1 NO + 1 NC

Cat.Nos	I min. (A)	I max. (A)	MRP* ₹ / Unit	Pack
---------	---------------	---------------	---------------------	------

RTX³ 225 - for CTX³ 225
Differential type with screw terminals

4167 80	65	100	9254	1
4167 81	85	125	9254	1
4167 82	100	160	9254	1
4167 83	120	185	9254	1
4167 84	160	240	9254	1

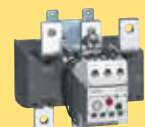

4167 84

Bold Cat.Nos are products normally available with Legrand (India) Stockists.
Cat.Nos that are not bold - delivery within 4 - 8 weeks from the date of order.
Bold packing quantity is our mandatory packing. Orders to be placed by Legrand (India) Stockist in multiples of the same.

Thermal relays RTX³ for CTX³ 3 pole industrial contactors

NEW!

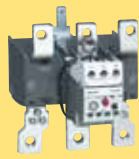

4167 91

Cat.Nos	I min. (A)	I max. (A)	MRP* ₹ / Unit	Pack
---------	------------	------------	---------------	------

RTX³ 400 - for CTX³ 400
Differential type with screw terminals

4167 86	85	125	13220	1
4167 87	100	160	13220	1
4167 88	120	185	13220	1
4167 89	160	240	13220	1
4167 90	200	330	13220	1
4167 91	260	400	13220	1

RTX³ 800 - for CTX³ 800
Differential type with screw terminals

4167 92	200	300	15422	1
4167 93	260	400	15422	1
4167 94	400	630	15422	1
4167 95	520	800	15422	1

4-pole contactors CTX³ 40A to 900A industrial contactors and spare coils



4164 36

Cat.Nos	Max. opt. current AC-1	Max. opt. current AC-3	Control voltage	MRP* ₹ / Unit	Pack
---------	------------------------	------------------------	-----------------	---------------	------

Contactors CTX³

Power terminals: screw terminals

Without integrated auxiliary contact

4164 26	40 A	22 A	230 V~	2644	1
4164 36	60 A	40 A	230 V~	7138	1
4164 46	100 A	65 A	230 V~	10466	1
4164 56	135 A	85 A	230 V~	16964	1



4164 56

With integrated auxiliary contacts

Auxiliary contacts: 2 NO + 2 NC

416466	165 A	130 A	100-240 V~/=	22032	1
416476	250 A	150 A	100-240 V~/=	27980	1
416486	330 A	225 A	100-240 V~/=	37454	1
416496	420 A	330 A	100-240 V~/=	50674	1
4165 06	500 A	400 A	100-240 V~/=	54420	1
4165 16	750 A	630 A	200-240 V~/=	111262	1
4165 26	900 A	800 A	200-240 V~/=	130980	1



4164 86

Spare coils for CTX³ 4P contactors

Cat.Nos	Description	MRP* ₹ / Unit	Pack
---------	-------------	---------------	------

Control voltage 230 V~

4165 46	For CTX ³ 40 A to 60 A (AC-1)	1310	3
4165 56	For CTX ³ 100 A to 135 A (AC-1)	1310	4
4165 66	For CTX ³ 165 A to 330 A (AC-1)	8186	1
4165 76	For CTX ³ 420 A to 500 A (AC-1)	15280	3
4165 86	For CTX ³ 750 A to 900 A (AC-1)	22920	3

■ Price available on request.

* MRP - Maximum Retail Price Inclusive of all taxes.

Red Cat.Nos - new products

NEW!

CTX³ accessories

Cat.Nos	Description	MRP* ₹ / Unit	Pack
---------	-------------	---------------	------



4168 50



4168 55

CTX³ add-on auxiliary contact blocks

Front mounting

For CTX³ 3P form 9 A to 150 A (AC-3) and CTX³ 4P from 40 A to 135 A (AC-1) - 2 and 4 pole - lth: 16 A

4168 50	1 NO + 1 NC	348	20
4168 51	2 NO	348	20
4168 52	2 NC	348	20
4168 53	4 NO	588	10
4168 54	3 NO + 1 NC	588	10
4168 55	2 NO + 2 NC	588	10
4168 56	1 NO + 3 NC	588	10
4168 57	4 NC	588	10

Side mounting

2 pole - Mounting on both sides

4168 58	For CTX ³ 3P Form 9 A to 150 A (AC-3) 1 NO + 1 NC - lth: 16 A	654	20
4168 59	For CTX ³ 3P Form 185 A to 800 A (AC-3) and CTX ³ 4P from 165 A to 900 A (AC-1) 1 NO + 1 NC - lth: 16 A	654	50
4168 49	For CTX ³ 4P From 40 A to 135 A (AC-1) 1 NO + 1 NC - lth: 16 A	654	60

CTX³ time delay blocks

For CTX³ 3P Form 9 A to 150 A (AC-3)

Time delay: 1 to 30 s

Front mounting

On delay

4168 70	24-48 V~/=	1764	1
4168 71	110-230 V~	1764	1



4168 70

Off delay

4168 72	24-48 V~/=	2424	1
4168 73	110-230 V~	2424	1

CTX³ capacitor switching units

AC-6b

Operating power from 9.7 kVAR to 62 kVAR (400/440 V)

4168 74	For contactors CTX ³ 3P from 9 to 40 A	1746	1
4168 75	For contactors CTX ³ 3P 50 and 65 A with screw terminals	2424	1
4168 76	For contactors CTX ³ 3P 50 and 65 A with cage terminals	2646	1
4168 77	For contactors CTX ³ 3P 75 to 100 A with screw terminals	2646	1

CTX³ interlocking

Component parts for assembling by customer

Horizontal mounting

Interlock units

4168 79	Mechanical interlocks for CTX ³ 4P from 40 to 135 A (AC-1)	982	50
---------	---	-----	----



4168 79

Bold Cat.Nos are products normally available with Legrand (India) Stockists. Cat.Nos that are not bold - delivery within 4 - 8 weeks from the date of order. Bold packing quantity is our mandatory packing. Orders to be placed by Legrand (India) Stockist in multiples of the same.

NEW!
CTX³ accessories

Cat.Nos	Description	MRP* ₹ / Unit	Pack
---------	-------------	------------------	------

Interlock units

4168 80	Mechanical interlocks for CTX ³ 3P from 9 to 150 A Provides 2 NC contacts for use in electrielectrical interlocking	2402	1
4168 87	Mechanical interlocks for CTX ³ 3P from 185 to 400 A and CTX ³ 4P from 165 to 500 A	3602	12
4168 88	Mechanical interlocks for CTX ³ 3P from 500 to 800 A	3930	1
4168 89	Mechanical interlocks for CTX ³ 4P from 750 to 900 A	4148	1

Wire kits

Used for making reversing between two 3P contactors

4168 82	For CTX ³ 22	1048	4
4168 83	For CTX ³ 40	1418	6
4168 84	For CTX ³ 65	1746	2
4168 85	For CTX ³ 100	2926	1



4168 91

Boxes for motor starter

 For CTX³ 22 equipped with RTX³ 40 (0.1 - 22 A)

4168 90	Without pushbuttons	2670	1
4168 91	With pushbuttons	3274	1

CTX³ transient voltage suppressor blocks

Absorbs the surge arisen out of the coil of the contactor

4168 95	24-48 V V~/=	492	10
4168 96	100-125 V~/=	492	10
4168 97	200-240 V~/=	492	10
4168 98	380-400 V~	492	10



4168 97

CTX³ terminals covers

4168 42	For CTX ³ 3P from 185 to 225 A (AC-3)	450	10
4168 43	For CTX ³ 3P from 265 to 400 A (AC-3)	674	25
4168 44	For CTX ³ 3P from 500 to 900 A (AC-3)	1010	5
4168 45	For CTX ³ 4P from 165 to 330 A (AC-1)	562	10
4168 46	For CTX ³ 4P from 420 to 500 A (AC-1)	854	10
4168 47	For CTX ³ 4P from 750 to 900 A (AC-1)	1438	5

CTX³ safety front cover

4168 40	For CTX ³ 3P from 9 to 150 A (AC-3) and CTX ³ 4P from 40 to 135 A (AC-1)	28	150
4168 41	For CTX ³ 3P from 85 to 800 A (AC-3) and CTX ³ 4P from 165 to 900 A (AC-1)	110	150



4168 40

* MRP - Maximum Retail Price Inclusive of all taxes.
Red Cat.Nos - new products

NEW!
CTX³ accessories

Cat.Nos	Description	MRP* ₹ / Unit	Pack
---------	-------------	------------------	------

Distant reset flexible cables for thermal relays

4168 92	400 mm	654	1
4168 93	500 mm	654	1
4168 94	600 mm	654	1

CTX³ spare coils
Spare coils for CTX³ 3 P contactors
For CTX³ 22

4169 00	24 V~	588	4
4169 02	48 V~	588	4
4169 04	110 V~	588	4
4169 06	230 V~	588	4
4169 08	380 V~	588	4
4169 09	415 V~	588	4

For CTX³ 40

4169 20	24 V~	588	6
4169 21	24 V=	588	6
4169 22	48 V~	588	6
4169 23	48 V=	588	6
4169 24	110 V~	588	6
4169 26	230 V~	588	6
4169 28	380 V~	588	6
4169 29	415 V~	588	6

For CTX³ 65

4169 30	24 V~	698	4
4169 31	24 V=	698	2
4169 32	48 V~	698	4
4169 33	48 V=	698	2
4169 34	110 V~	698	4
4169 36	230 V~	698	4
4169 38	380 V~	698	4
4169 39	415 V~	698	4

For CTX³ 100

4169 40	24 V~	852	3
4169 41	24 V=	852	2
4169 42	48 V~	852	3
4169 43	48 V=	852	2
4169 44	110 V~	852	3
4169 46	230 V~	852	3
4169 48	380 V~	852	3
4169 49	415 V~	852	3

For CTX³ 150

4169 50	24 V~	5020	2
4169 51	24 V=	5020	2
4169 52	48 V~	5020	2
4169 53	48 V=	5020	2
4169 56	100-240 V~/=	5020	2
4169 59	400-440 V~	5020	2

For CTX³ 225

4169 60	24 V~/=	5894	1
4169 62	48 V~/=	5894	1
4169 66	100-240 V~/=	5894	1
4169 69	400-440 V~	5894	1

For CTX³ 400

4169 76	100-240 V~/=	10914	3
4169 79	380-450 V~	10914	3

For CTX³ 400

4169 86	200-240 V~/=	17244	3
4169 89	380-450 V~	17244	3



4169 66

Bold Cat.Nos are products normally available with Legrand (India) Stockists. Cat.Nos that are not bold - delivery within 4 - 8 weeks from the date of order. Bold packing quantity is our mandatory packing. Orders to be placed by Legrand (India) Stockist in multiples of the same.

NEW!

Control relays CTX³

Cat.Nos	Description	MRP* ₹ / Unit	Pack
---------	-------------	------------------	------

CTX³ control relays

4 pole
Conform to IEC 60 947-1, IEC 60 947-4-1 and IEC 60 947-5-1 for the auxiliary contacts
Can be equipped with CTX³ mini
Ith = 10 A
Low consumption coil

4 NO

4168 00	24 V~	1058	1
4168 01	24 V=	1652	1
4168 02	48 V~	1058	1
4168 03	48 V=	1652	1
4168 04	110 V~	1058	1
4168 06	230 V~	1058	1
4168 09	400 V~	1058	1

3 NO + 1 NC

4168 10	24 V~	1058	1
4168 11	24 V=	1652	1
4168 12	48 V~	1058	1
4168 13	48 V=	1652	1
4168 14	110 V~	1058	1
4168 16	230 V~	1058	1
4168 19	400 V~	1058	1

2 NO + 2 NC

4168 20	24 V~	1058	1
4168 21	24 V=	1652	1
4168 22	48 V~	1058	1
4168 23	48 V=	1652	1
4168 24	110 V~	1058	1
4168 26	230 V~	1058	1
4168 29	400 V~	1058	1



4168 10

**MPCBs MPX³
motor protection circuit breakers from 0.16 A to 100 A**

Cat.Nos	Rated 3Ph Motor	Thermal release adj. range (A)	Magnetic release operating current (A)	MRP* ₹ / Unit	Pack
---------	-----------------	--------------------------------	--	------------------	------

Thermal magnetic MPCBs

Adjustable thermal release Magnetic release 13 le max.

MPX³ 32S - 3P

Standard breaking capacity with toggle handle
Fixing on rail □
415 V breaking capacity Icu (kA) - 100

4173 00	0.02	0.1 to 0.16	2.1	3098	1
4173 01	0.06	0.16 to 0.25	3.3	3098	1
4173 02	0.09	0.25 to 0.4	5.2	3098	1
4173 03	0.12	0.4 to 0.63	8.2	3602	1
4173 04	0.18 / 0.25	0.63 to 1	13	3602	1
4173 05	0.37 / 0.55	1 to 1.6	20.8	3624	1
4173 06	0.75	1.6 to 2.5	32.5	3624	1
4173 07	1.5	2.5 to 4	52	3754	1
4173 08	2.2	4 to 6	78	3754	1
4173 09	3	5 to 8	104	3754	1



4173 08

* MRP - Maximum Retail Price Inclusive of all taxes.
Red Cat.Nos - new products

NEW!

MPCBs MPX³

motor protection circuit breakers from 0.16 A to 100 A

Cat.Nos	Rated 3Ph Motor	Thermal release adj. range (A)	Magnetic release operating current (A)	MRP* ₹ / Unit	Pack
---------	-----------------	--------------------------------	--	------------------	------

415 V breaking capacity Icu (kA) - 50

4173 10	4	6 to 10	130	3754	1
4173 11	5.5	9 to 13	169	4256	1

415 V breaking capacity Icu (kA) - 20

4173 12	7.5	11 to 17	221	4584	1
---------	-----	----------	-----	------	---

415 V breaking capacity Icu (kA) - 15

4173 13	7.5	14 to 22	286	5238	1
4173 14	11	18 to 26	338	5238	1
4173 15	15	22 to 32	416	8622	1

MPX³ 32H - 3P

High breaking capacity with rotary handle
Fixing on rail □
415 V breaking capacity Icu (kA) - 100

4173 20	0.02	0.1 to 0.16	2.1	3862	1
4173 21	0.06	0.16 to 0.25	3.3	3862	1
4173 22	0.09	0.25 to 0.4	5.2	3862	1
4173 23	0.12	0.4 to 0.63	8.2	4236	1
4173 24	0.18 / 0.25	0.63 to 1	13	4236	1
4173 25	0.37 / 0.55	1 to 1.6	20.8	4236	1
4173 26	0.75	1.6 to 2.5	32.5	4236	1
4173 27	1.5	2.5 to 4	52	4366	1
4173 28	2.2	4 to 6	78	4366	1
4173 29	3	5 to 8	104	4672	1
4173 30	4	6 to 10	130	4672	1
4173 31	5.5	9 to 13	169	5282	1

415 V breaking capacity Icu (kA) - 50

4173 32	7.5	11 to 17	221	6548	1
4173 33	7.5	14 to 22	286	6548	1
4173 34	11	18 to 26	338	6548	1
4173 35	15	22 to 32	416	10260	1

MPX³ 63H - 3P

High breaking capacity with rotary handle
Fixing on rail □ or by screw
415 V breaking capacity Icu (kA) - 100

4173 60	4	6 to 10	130	9822	1
4173 61	5.5	9 to 13	169	9822	1

415 V breaking capacity Icu (kA) - 50

4173 62	7.5	11 to 17	221	9822	1
4173 63	7.5	14 to 22	286	11132	1
4173 64	11	18 to 26	338	11132	1
4173 65	15	22 to 32	416	11132	1
4173 66	18.5	28 to 40	520	12442	1
4173 67	22	34 to 50	650	15280	1
4173 68	30	45 to 63	819	16152	1



4173 68

MPX³ 100H - 3P

High breaking capacity with rotary handle
Fixing on rail □ or by screw
415 V breaking capacity Icu (kA) - 100

4173 70	7.5	11 to 17	221	13576	1
4173 71	7.5	14 to 22	286	13576	1
4173 72	11	18 to 26	338	13576	1
4173 73	15	22 to 32	416	13576	1
4173 74	18.5	28 to 40	520	13576	1
4173 75	22	34 to 50	650	16136	1
4173 76	30	45 to 63	819	16914	1

Bold Cat.Nos are products normally available with Legrand (India) Stockists.
Cat.Nos that are not bold - delivery within 4 - 8 weeks from the date of order.
Bold packing quantity is our mandatory packing. Orders to be placed by Legrand (India) Stockist in multiples of the same.

MPCBs MPX³

motor protection circuit breakers from 0.16 A to 100 A

NEW!



4173 79

Cat.Nos	Rated 3Ph Motor	Thermal release adj. range (A)	Magnetic release operating current (A)	MRP* ₹ / Unit	Pack
415 V breaking capacity Icu (kA) - 75					
4173 77	37	55 to 75	975	18186	1
4173 78	45	70 to 90	1170	18186	1
4173 79	45	80 to 100	1300	18186	1

Magnetic only MPCBs

Without thermal release
Magnetic release 13 x Ie max.

Cat.Nos	Rated 3Ph Motor	Magnetic release operating current (A)	MRP* ₹ / Unit	Pack
4173 40	0.02	2.1	3492	1
4173 41	0.06	3.3	3492	1
4173 42	0.09	5.2	3492	1
4173 43	0.12	8.2	3886	1
4173 44	0.18 / 0.25	13	3886	1
4173 45	0.37 / 0.55	20.8	3886	1
4173 46	0.75	32.5	3886	1
4173 47	1.5	52	3930	1
4173 48	2.2	78	3930	1
4173 49	3	104	3930	1
4173 50	4	130	4148	1
4173 51	5.5	169	4408	1

MPX³ 32MA - 3P

High breaking capacity with rotary handle
Fixing on rail

415 V breaking capacity Icu (kA) - 100

4173 40	0.02	2.1	3492	1
4173 41	0.06	3.3	3492	1
4173 42	0.09	5.2	3492	1
4173 43	0.12	8.2	3886	1
4173 44	0.18 / 0.25	13	3886	1
4173 45	0.37 / 0.55	20.8	3886	1
4173 46	0.75	32.5	3886	1
4173 47	1.5	52	3930	1
4173 48	2.2	78	3930	1
4173 49	3	104	3930	1
4173 50	4	130	4148	1
4173 51	5.5	169	4408	1

4173 48

415 V breaking capacity Icu (kA) - 50

4173 52	7.5	221	5676	1
4173 53	7.5	286	5676	1
4173 54	11	338	5676	1
4173 55	15	416	9386	1

MPCBs MPX³ accessories

Cat.Nos	Description	MRP* ₹ / Unit	Pack
---------	-------------	---------------	------

Auxiliary contacts

2 pole

Side mounting

Mounting on the left side of MPCBs
Two auxiliary contacts per MPCB

4174 00	1 NO + 1 NC	742	2
4174 01	2 NO	742	2
4174 02	2 NC	742	2

4174 00

Front mounting

One auxiliary contact per MPCB

4174 03	1 NO + 1 NC	764	10
4174 04	2 NO	764	10
4174 05	2 NC	764	10

4174 03

Alarm contacts

1 NO + 1 NC

Any trip alarm contact

Operate in case of trip
Mounting on the left side of MPCBs
Set alarm contact first in case of using auxiliary contact together (MPX³ 63H can not accept auxiliary contact and alarm contact together)

4174 06	For MPX ³ 32	1200	1
4174 08	For MPX ³ 63 and 100	1200	1

* MRP - Maximum Retail Price Inclusive of all taxes.
Red Cat.Nos - new products

NEW!

MPCBs MPX³ accessories

Cat.Nos	Description	MRP* ₹ / Unit	Pack
---------	-------------	---------------	------

Magnetic trip alarm contact

Operate in case of instantaneous trip
Mounting on the left side of MPCBs
Set alarm contact first in case of using auxiliary contact together

4174 07	1 NO + 1 NC	1200	2
---------	-------------	------	---

Shunt release

Mounting on the right side of MPCBs
One release per MPCB

4174 10	24 V - 50 Hz / 28 V - 60 Hz	1964	1
4174 11	110 V - 50 Hz / 120 V - 60 Hz	1964	1
4174 12	220-230 V - 50 Hz / 240-260 V - 60 Hz	1964	1
4174 13	380-400 V - 50 Hz / 440-460 V - 60 Hz	1964	1

4174 12

Undervoltage release

Mounting on the right side of MPCBs
One release per MPCB

Without auxiliary contact

4174 20	24 V - 50 Hz / 28 V - 60 Hz	1964	1
4174 21	110 V - 50 Hz / 120 V - 60 Hz	1964	1
4174 22	220-230 V - 50 Hz / 240-260 V - 60 Hz	1964	1
4174 23	380-400 V - 50 Hz / 440-460 V - 60 Hz	1964	1

4174 22

With 2 NO auxiliary contacts

Can not attach to MPX³ 32S

4174 30	24 V - 50 Hz / 28 V - 60 Hz	2620	1
4174 31	110 V - 50 Hz / 120 V - 60 Hz	2620	1
4174 32	220-230 V - 50 Hz / 240-260 V - 60 Hz	2620	1
4174 33	380-400 V - 50 Hz / 440-460 V - 60 Hz	2620	1

Dial Cover

Sealable cover to protect the set value from the operation that is not intended

Without auxiliary contact

4174 79	For all types of MPX ³	88	100
---------	-----------------------------------	----	-----

Direct adaptor and mounting unit

For mounting CTX³ contactors under MPX³ MPCBs

Direct adaptators

Used to connect MPX³ directly with the contactor

4174 40	For MPX ³ 32S with CTX ³ mini AC	436	2
4174 41	For MPX ³ 32S with CTX ³ mini DC	436	2
4174 42	For MPX ³ 32H/32MA with CTX ³ mini AC	436	2
4174 43	For MPX ³ 32H/32MA with CTX ³ mini DC	436	2
4174 48	For MPX ³ 32S with CTX ³ 22 AC	524	2
4174 49	For MPX ³ 32S with CTX ³ 22 DC	524	2
4174 50	For MPX ³ 32H/32MA with CTX ³ 22 AC	524	2



4174 50

Bold Cat.Nos are products normally available with Legrand (India) Stockists. Cat.Nos that are not bold - delivery within 4 - 8 weeks from the date of order. Bold packing quantity is our mandatory packing. Orders to be placed by Legrand (India) Stockist in multiples of the same.

NEW!

MPCBs MPX³ accessories

Cat.Nos	Description	MRP* ₹ / Unit	Pack
---------	-------------	------------------	------

Direct adaptators

Used to connect MPX³ directly with the contactor

4174 51	For MPX ³ 32H/32MA with CTX ³ 22 DC	524	2
4174 52	For MPX ³ 32S with CTX ³ 40 AC	634	2
4174 53	For MPX ³ 32S with CTX ³ 40 DC	634	2
4174 54	For MPX ³ 32H/32MA with CTX ³ 40 AC	634	2
4174 55	For MPX ³ 32H/32MA with CTX ³ 40 DC	634	2
4174 56	For MPX ³ 63H with CTX ³ 65 AC with cage type terminals	764	2
4174 57	For MPX ³ 63H with CTX ³ 65 DC with cage type terminals	764	2
4174 58	For MPX ³ 100H with CTX ³ 100 AC with cage type terminals	764	1
4174 59	For MPX ³ 100H with CTX ³ 100 DC with cage type terminals	764	1

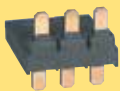

4174 56



4174 61



4174 63



4174 73



4174 81

Mounting unit

This device is used for joining together MPX³ MCPBs and CTX³ contactors

4174 60	For MPX ³ 32S/32H/32MA	588	2
4174 61	For MPX ³ 63H	1092	1
4174 62	For MPX ³ 100H	1310	1

Rotary handle

Mounting on panel's door to control the MPX³

4174 63	For MPX ³ 32H and 32 MA	2182	1
4174 64	For MPX ³ 63H	2182	1
4174 65	For MPX ³ 100H	2182	1

Phase busbar

For parallel connection of MPX³

For MPX³ 32S, 32H and 32MA

Rated current 63 A

4174 71	2 devices	612	10
4174 73	3 devices	1528	10
4174 75	4 devices	1528	10
4174 76	5 devices	1528	10
4174 77	Feeder for phase busbar 32 A	426	4

For MPX³ 63H

Rated current 108 A

4174 72	2 devices	1092	4
4174 74	3 devices	1638	4

Enclosures for MPX³ 32H and 32MA

IP 65 enclosure to use in dusty areas as well as in presence of corrosive gas or liquid

4174 80	Yellow/red with rotary handle	890	1
4174 81	With black rotary handle	1638	1

* MRP - Maximum Retail Price Inclusive of all taxes.
Red Cat.Nos - new products

XL³

XL³ enclosure for safety and flexibility



- Totally type-tested system as per IEC 61439-1
- Completely bolted system for ease of assembly
- Modular design for numerous configurations
- Short time current withstand capacity upto 110 kA
- Design suitable for Form 4b
- IP 55 degree of protection also available
- Fire resistance of 750 °C for 30 sec
- Compatible with Zucchini busbar trunking system
- Adjustable plinth height for the better spreading of cables
- Permanent earthing for internal components and external faceplates
- Perfectly house the whole range of Legrand ACBs, MCCBs, Capacitors, MCBs, Metering devices and OMPs like VSP, MPCB etc.

Bold Cat.Nos are products normally available with Legrand (India) Stockists. Cat.Nos that are not bold - delivery within 4 - 8 weeks from the date of order. Bold packing quantity is our mandatory packing. Orders to be placed by Legrand (India) Stockist in multiples of the same.

Alpican™

Resin filled capacitors

Cat.Nos	Description	LP* ₹ / Unit	Pack
---------	-------------	--------------------	------

Standard duty Resin filled capacitor 440 V, 3 phase, 50 Hz

4151 00	1 KVAR	250	1/12
4151 01	2.1 KVAR	526	1/12
4151 02	3 KVAR	754	1/12
4151 03	4.2 KVAR	1046	1/12
4151 04	5 KVAR	1246	1/12
4151 05	7.5 KVAR	1690	1/6
4151 06	10 KVAR	2190	1/4
4151 07	12.5 KVAR	2846	1/4
4151 08	15 KVAR	3284	1/4
4151 09	20 KVAR	4380	1/4
4151 10	25 KVAR	5472	1/4
4151 11	30 KVAR	6824	1/4



4151 10

Heavy duty Resin filled capacitor 440 V, 3 phase

4151 12	1 KVAR	436	1/12
4151 13	2.1 KVAR	924	1/12
4151 14	3 KVAR	1318	1/6
4151 15	4.2 KVAR	1846	1/6
4151 16	5 KVAR	2158	1/6
4151 17	7.5 KVAR	3150	1/4
4151 18	10 KVAR	4160	1/4
4151 19	12.5 KVAR	5198	1/4
4151 20	15 KVAR	6238	1/4
4151 21	20 KVAR	8316	1/4
4151 22	25 KVAR	10300	1/2
4151 23	30 KVAR	12950	1/2



4151 23

Alpican™

Gas filled capacitors

Heavy duty gas filled capacitor 440 V, 3 phase, 50 Hz

4151 24	5.2 KVAR	2434	1/4
4151 25	7.3 KVAR	3386	1/4
4151 26	8.8 KVAR	4002	1/4
4151 27	10.5 KVAR	4870	1/4
4151 28	12.6 KVAR	5730	1/4
4151 29	16.8 KVAR	8038	1/4
4151 30	21 KVAR	9556	1/4
4151 31	25.2 KVAR	11358	1/4



4151 29

* LP -List Price Inclusive of excise duty but exclusive of sales tax or any other taxes.

Alpican™

Resin filled capacitor for reactors

Cat.Nos	Description	LP* ₹ / Unit	Pack
---------	-------------	--------------------	------

Standard duty Resin filled capacitor 525 V, 3 phase, 50 Hz

4151 32	5 KVAR	2406	1/6
4151 33	8.3 KVAR	3996	1/4
4151 34	10.4 KVAR	5000	1/4
4151 35	12.5 KVAR	6014	1/4
4151 36	17.5 KVAR	8036	1/4
4151 37	20.8 KVAR	10008	1/4
4151 38	25 KVAR	11916	1/4

Reactors and power factor controllers

Reactors 7 % duty

4151 48	Reactor 10 KVAR	13780	1
4151 49	Reactor 12.5 KVAR	18044	1
4151 50	Reactor 25 KVAR	22752	1
4151 51	Reactor 50 KVAR	37002	1
4151 52	Reactor 100 KVAR	74114	1



4151 50

Reactors 14 % duty

4151 53	Reactor 12.5 KVAR	21444	1
4151 54	Reactor 25 KVAR	35742	1
4151 55	Reactor 50 KVAR	47254	1

Power factor controller

ALPTEC3.2	Controller 3 steps	12800	1
ALPTEC5.2	Controller 5 steps	14800	1
ALPTEC8.2	Controller 8 steps	18400	1
ALPTEC8	Controller 8 steps static	22000	1
EXT2GR	Module extension 2 steps	2000	1
EXT3GR	Module extension 3 steps	4200	1
EXT4GRS	Module extension 4 steps for static with Alptec8	6000	1
EXTETH	Ethernet module for Alptec 8.2 & Alptec 8	22000	1
EXTHARM	Harmonic protection module Alptec 8.2 & Alptec 8.2	18000	1
EXTRS485	RS 485 module	8000	1

Alpican™

Guarantee

- The Company, at its discretion, will replace products if they have any manufacturing defect within 1 years for capacitor, Reactor & APFC controller.
- The above guarantee is applicable when the products are selected taken into consideration all the technical characteristics of the product published in our catalogue.
- The guarantee is only applicable when the products are installed as per the Company's instructions and not tampered in any manner.
- The guarantee states the Company's entire liability. It does not extend to cover consequential loss or damage or installation costs arising from defective products.

Bold Cat.Nos are products normally available with Legrand (India) Stockists. Cat.Nos that are not bold - delivery within 4 - 8 weeks from the date of order. Bold packing quantity is our mandatory packing. Orders to be placed by Legrand (India) Stockist in multiples of the same.



Sliding shutters



COPYTRACER
Anti-counterfeit registration number



Improved air channels



Bottom clamp



Environment friendly



DX³ The Next Step.

Presenting, DX³, an international range of protection devices. Its revolutionary design supports all kind of installations thus giving a never before experience. With 10 patents and 13 new features, it defines the next step in the protection category.

New top clamp
for all tools

Technical
labelling area



Integrated label
holder



Black handle: circuit breakers
Grey handle: switches

Breaking capacity

- 16 kA
- 25 kA
- 36 kA
- 50 kA

Colour coded
handle with
ON/OFF
colour indication



DX³ MCBs

Cat.Nos	Nominal Rating	Number of 17.5 mm modules	MRP* ₹ / Unit	Pack
---------	----------------	---------------------------	---------------	------

MCBs for AC applications till 63 A

10 kA ISI marked as per IS/IEC 60898-1 2002
 Integrated label holder
 Sliding bottom clamp
 Improved air channels
 Color coded On/Off indication on dolly
 Biconnect lower terminals
 IP 20 protected terminals
 Sliding shutters
 DC-80 V per pole - 1 kA

C Curve

Single pole 240/410 V

4085 80	0.5	1	448	1/10/120
4085 81	1	1	448	1/10/120
4085 83	2	1	448	1/10/120
4085 84	3	1	448	1/10/120
4085 85	4	1	448	1/10/120
4085 87	6	1	294	1/10/120
4085 90	10	1	294	1/10/120
4085 92	16	1	294	1/10/120
4085 93	20	1	294	1/10/120
4085 94	25	1	294	1/10/120
4085 95	32	1	294	1/10/120
4085 96	40	1	638	1/10/120
4085 97	50	1	638	1/10/120
4085 98	63	1	638	1/10/120



4085 90

Single pole + Neutral 240 V

4086 02	0.5	2	1216	1/5/60
4086 03	1	2	1216	1/5/60
4086 05	2	2	1216	1/5/60
4086 06	3	2	1216	1/5/60
4086 07	4	2	1216	1/5/60
4086 09	6	2	872	1/5/60
4086 12	10	2	872	1/5/60
4086 14	16	2	872	1/5/60
4086 15	20	2	872	1/5/60
4086 16	25	2	872	1/5/60
4086 17	32	2	872	1/5/60
4086 18	40	2	1404	1/5/60
4086 19	50	2	1404	1/5/60
4086 20	63	2	1404	1/5/60



4086 14

Double pole 415 V

4086 21	0.5	2	1216	1/40
4086 22	1	2	1216	1/40
4086 24	2	2	1216	1/40
4086 25	3	2	1216	1/40
4086 26	4	2	1216	1/40
4086 28	6	2	872	1/40
4086 31	10	2	872	1/40
4086 33	16	2	872	1/40
4086 34	20	2	872	1/40
4086 35	25	2	872	1/40
4086 36	32	2	872	1/40
4086 37	40	2	1404	1/40
4086 38	50	2	1404	1/40
4086 39	63	2	1404	1/40



4086 37

Triple pole 415 V

4086 43	0.5	3	1882	1/32
4086 44	1	3	1882	1/32
4086 46	2	3	1882	1/32
4086 47	3	3	1882	1/32
4086 48	4	3	1882	1/32
4086 50	6	3	1422	1/32
4086 53	10	3	1422	1/32
4086 55	16	3	1422	1/32
4086 56	20	3	1422	1/32
4086 57	25	3	1422	1/32
4086 58	32	3	1422	1/32
4086 59	40	3	2174	1/32
4086 60	50	3	2174	1/32
4086 61	63	3	2174	1/32



4086 55

* MRP - Maximum Retail Price Inclusive of all taxes.

* For further details on product contact nearest Legrand Sales Office.

DX³ MCBs

Cat.Nos	Nominal Rating	Number of 17.5 mm modules	MRP* ₹ / Unit	Pack
---------	----------------	---------------------------	---------------	------

Triple pole + Neutral 415 V

4086 65	0.5	4	2360	1/32
4086 66	1	4	2360	1/32
4086 68	2	4	2360	1/32
4086 69	3	4	2360	1/32
4086 70	4	4	2360	1/32
4086 72	6	4	1924	1/32
4086 75	10	4	1924	1/32
4086 77	16	4	1924	1/32
4086 78	20	4	1924	1/32
4086 79	25	4	1924	1/32
4086 80	32	4	1924	1/32
4086 81	40	4	2774	1/32
4086 82	50	4	2774	1/32
4086 83	63	4	2774	1/32



4086 77

Four pole 415 V

4086 84	0.5	4	2360	1/32
4086 85	1	4	2360	1/32
4086 87	2	4	2360	1/32
4086 88	3	4	2360	1/32
4086 89	4	4	2360	1/32
4086 91	6	4	1924	1/32
4086 94	10	4	1924	1/32
4086 96	16	4	1924	1/32
4086 97	20	4	1924	1/32
4086 98	25	4	1924	1/32
4086 99	32	4	1924	1/32
4087 00	40	4	2774	1/32
4087 01	50	4	2774	1/32
4087 02	63	4	2774	1/32



4086 94

D Curve

Single pole 240/415 V

4087 06	0.5	1	448	1/10/120
4087 07	1	1	448	1/10/120
4087 09	2	1	448	1/10/120
4087 10	3	1	448	1/10/120
4087 11	4	1	448	1/10/120
4087 12	6	1	376	1/10/120
4087 14	10	1	376	1/10/120
4087 16	16	1	376	1/10/120
4087 17	20	1	376	1/10/120
4087 18	25	1	376	1/10/120
4087 19	32	1	376	1/10/120
4087 20*	40	1	674	1/10/120
4087 21*	50	1	674	1/10/120
4087 22*	63	1	674	1/10/120



4087 19

Single pole + Neutral 240 V

4087 26	0.5	2	1216	1/5/60
4087 27	1	2	1216	1/5/60
4087 29	2	2	1216	1/5/60
4087 30	3	2	1216	1/5/60
4087 31	4	2	1216	1/5/60

Double pole 415 V

4087 32	0.5	2	1216	1/40
4087 33	1	2	1216	1/40
4087 35	2	2	1216	1/40
4087 36	3	2	1216	1/40
4087 37	4	2	1216	1/40
4087 38	6	2	900	1/40
4087 40	10	2	900	1/40
4087 42	16	2	900	1/40
4087 43	20	2	900	1/40
4087 44	25	2	876	1/40
4087 45	32	2	900	1/40
4087 46*	40	2	1456	1/40
4087 47*	50	2	1456	1/40
4087 48*	63	2	1456	1/40



4087 46

Bold Cat.Nos are products normally available with Legrand (India) Stockists. Cat.Nos that are not bold - delivery within 4 - 8 weeks from the date of order. Bold packing quantity is our mandatory packing. Orders to be placed by Legrand (India) Stockist in multiples of the same.

DX³ MCBs

Cat.Nos	Nominal Rating	Number of 17.5 mm modules	MRP* ₹ / Unit	Pack
---------	----------------	---------------------------	---------------	------

Triple pole 415 V

4087 52	0.5	3	1882	1/32
4087 53	1	3	1882	1/32
4087 55	2	3	1882	1/32
4087 56	3	3	1882	1/32
4087 57	4	3	1882	1/32
4087 58	6	3	1484	1/32
4087 60	10	3	1484	1/32
4087 62	16	3	1484	1/32
4087 63	20	3	1484	1/32
4087 64	25	3	1484	1/32
4087 65	32	3	1484	1/32
4087 66*	40	3	2290	1/32
4087 67*	50	3	2290	1/32
4087 68*	63	3	2290	1/32



4087 52

Triple pole + Neutral 415 V

4087 72	0.5	4	2360	1/32
4087 73	1	4	2360	1/32
4087 75	2	4	2360	1/32
4087 76	3	4	2360	1/32
4087 77	4	4	2360	1/32

Four pole 415 V

4087 78	0.5	4	2360	1/32
4087 79	1	4	2360	1/32
4087 81	2	4	2360	1/32
4087 82	3	4	2360	1/32
4087 83	4	4	2360	1/32
4087 84	6	4	1978	1/32
4087 86	10	4	1978	1/32
4087 88	16	4	1978	1/32
4087 89	20	4	1978	1/32
4087 90	25	4	1978	1/32
4087 91	32	4	1978	1/32
4087 92*	40	4	2852	1/32
4087 93*	50	4	2852	1/32
4087 94*	63	4	2852	1/32



4087 90

Circuit breakers AC applications 80 - 125 A

10 kA as per IEC 60947-2
Integrated label holder
Sliding insulating shield
Color coded contact indication window
IP 20 protected terminals
50 sq mm terminals



4086 00

Single pole 230 V / 400 V

4085 99	80	1.5	2312	1/5/160
4086 00	100	1.5	2590	1/5/161
4086 01	125	1.5	2796	1/5/162



4086 40

Double pole 230 V / 400 V

4086 40	80	3	5124	1/5/60
4086 41	100	3	5466	1/5/60
4086 42	125	3	6010	1/5/60



4086 63

Triple pole 400 V

4086 62	80	4.5	8078	1/9
4086 63	100	4.5	8608	1/9
4086 64	125	4.5	9550	1/9



4087 05

Four pole 400 V

4087 03	80	6	10528	1/9
4087 04	100	6	10970	1/9
4087 05	125	6	12412	1/9

* MRP - Maximum Retail Price Inclusive of all taxes.

* For further details on product contact nearest Legrand Sales Office.

DX³ MCBs

Cat.Nos	Nominal Rating	Number of 17.5 mm modules	MRP* ₹ / Unit	Pack
---------	----------------	---------------------------	---------------	------

Circuit breakers DC applications upto 63 A

6 kA as per IEC 60947-2
Integrated label holder
Sliding bottom clamp
Improved air channels
Color coded On/Off indication on dolly
Biconnect lower terminals
IP 20 protected terminals
Sliding shutters

Single pole 250 V

4087 98*	0.5	1	708	1/10/120
4087 99*	1	1	708	1/10/120
4088 01*	2	1	708	1/10/120
4088 02*	3	1	708	1/10/120
4088 03*	4	1	708	1/10/120
4088 04*	6	1	598	1/10/120
4088 06*	10	1	598	1/10/120
4088 08*	16	1	598	1/10/120
4088 09*	20	1	598	1/10/120
4088 10*	25	1	598	1/10/120
4088 11*	32	1	598	1/10/120
4088 12*	40	1	788	1/10/120
4088 13*	50	1	788	1/10/120
4088 14*	63	1	788	1/10/120



4088 12

Double pole 250 V

4088 15*	0.5	1	1446	1/5/60
4088 16*	1	1	1446	1/5/60
4088 18*	2	1	1446	1/5/60
4088 19*	3	1	1446	1/5/60
4088 20*	4	1	1446	1/5/60
4088 21*	6	1	1266	1/5/60
4088 23*	10	1	1266	1/5/60
4088 25*	16	1	1266	1/5/60
4088 26*	20	1	1266	1/5/60
4088 27*	25	1	1266	1/5/60
4088 28*	32	1	1266	1/5/60
4088 29*	40	1	1594	1/5/60
4088 30*	50	1	1594	1/5/60
4088 31*	63	1	1594	1/5/60

RDSO DC MCB

Single pole

4088 32	0.5	1	680	1/10/120
4088 33	1	1	680	1/10/120
4088 34	1.5	1	680	1/10/120
4088 35	1.6	1	680	1/10/120
4088 36	2.5	1	680	1/10/120
4088 37	3	1	508	1/10/120
4088 38	4	1	508	1/10/120
4088 39	5	1	616	1/10/120
4088 40	10	1	616	1/10/120
4088 41	15	1	616	1/10/120
4088 42	20	1	616	1/10/120
4088 43	25	1	616	1/10/120
4088 44	30	1	730	1/10/120
4088 45	35	1	730	1/10/120
4088 46	40	1	800	1/10/120
4088 47	50	1	800	1/10/120
4088 48	60	1	800	1/10/120

Bold Cat.Nos are products normally available with Legrand (India) Stockists. Cat.Nos that are not bold - delivery within 4 - 8 weeks from the date of order. Bold packing quantity is our mandatory packing. Orders to be placed by Legrand (India) Stockist in multiples of the same.

DX³ isolators

Cat.Nos	Nominal Rating	Number of 17.5 mm modules	MRP* ₹ / Unit	Pack
---------	----------------	---------------------------	---------------	------

Isolators for AC applications upto 125 A

ISI marked as per IEC 60947-3
 Integrated label holder
 Ergonomic red color dolly
 Sliding bottom clamp
 Double break mechanism
 Improved air channels
 Color coded On/Off indication on dolly
 Biconnect lower terminals
 IP 20 protected terminals
 Sliding shutters

Double pole 240 V

4065 00	32	2	482	1/5/60
4065 01	40	2	528	1/5/60
4065 02	63	2	700	1/5/60
4065 04	100	2	952	1/5/60
4065 05	125	2	1082	1/5/60



4065 00



4065 10



4065 20

Triple pole 415 V

4065 09	32	3	862	1/40
4065 10	40	3	920	1/40
4065 11	63	3	1090	1/40
4065 13	100	3	1216	1/40
4065 14	125	3	1406	1/40

Four pole 415 V

4065 18	32	4	946	1/32
4065 19	40	4	1176	1/32
4065 20	63	4	1286	1/32
4065 22	100	4	1584	1/32
4065 23	125	4	1744	1/32

DX³ RCCBs

RCCBs for AC applications upto 63 A

ISI marked as per IS 12640-1
 Integrated label holder
 Ergonomic Grey color dolly
 Sliding bottom clamp
 Color coded On/Off indication on dolly
 Biconnect lower terminals
 IP 20 protected terminals
 35 sq mm terminals
 Sliding shutters

Double pole 240 V

30 mA

4118 51	25	2	3108	1/5/60
4118 52	40	2	3640	1/5/60
4118 53	63	2	4350	1/5/60



4118 51



4118 57

100 mA

4118 56	25	2	3350	1/5/60
4118 57	40	2	3888	1/5/60
4118 58	63	2	4618	1/5/60

300 mA

4118 61	25	2	3412	1/5/60
4118 62	40	2	3974	1/5/60
4118 63	63	2	4646	1/5/60

Four pole 415 V

30 mA

4118 76	25	4	4282	1/32
4118 77	40	4	4232	1/32
4118 78	63	4	4908	1/32



4118 77

DX³ RCCBs

Cat.Nos	Nominal Rating	Number of 17.5 mm modules	MRP* ₹ / Unit	Pack
---------	----------------	---------------------------	---------------	------

100 mA

4118 81	25	4	4444	1/32
4118 82	40	4	4470	1/32
4118 83	63	4	5278	1/32

300 mA

4118 86	25	4	4550	1/32
4118 87	40	4	4618	1/32
4118 88	63	4	5278	1/32



4118 83



4118 93



4118 97



4115 08



4115 27



4117 05



4117 15



4117 25

Four pole 415 V, A-S

300 mA

4118 91	25	2	6594	1/5/60
4118 92	40	2	6678	1/5/60
4118 93	63	2	6976	1/5/60
4118 94	80	2	8160	1/5/60

Double pole 240 V, HPI

30 mA

4118 71	25	2	6506	1/5/60
4118 72	40	2	6832	1/5/60
4118 73	63	2	7028	1/5/60
4118 74	80	2	8420	1/5/60

Four pole 415 V, HPI

30 mA

4118 96	25	4	7326	1/32
4118 97	40	4	7556	1/32
4118 98	63	4	7754	1/32
4118 99	80	4	9154	1/32

DX³ circuit breakers

AC applications upto 100 A

Integrated label holder
 Ergonomic Grey color dolly
 Color coded On/Off indication on dolly
 Biconnect lower terminals
 IP 20 protected terminals
 35 sq mm terminals
 Sliding shutters

Double pole 240 V

30 mA

4115 07	80	2	7270	1/5/60
4115 08	100	2	7900	1/5/60

100 mA

4115 17	80	2	7270	1/5/60
4115 18	100	2	7900	1/5/60

300 mA

4115 27	80	2	7270	1/5/60
4115 28	100	2	7900	1/5/60

Four pole 415 V

30 mA

4117 05	80	4	8534	1/32
4117 63	100	4	8814	1/32

100 mA

4117 15	80	4	8534	1/32
4117 73	100	4	8814	1/32

300 mA

4117 25	80	4	8534	1/32
4117 83	100	4	8814	1/32

Bold Cat.Nos are products normally available with Legrand (India) Stockists. Cat.Nos that are not bold - delivery within 4 - 8 weeks from the date of order. **Bold packing quantity** is our mandatory packing. Orders to be placed by Legrand (India) Stockist in multiples of the same.

* MRP - Maximum Retail Price Inclusive of all taxes.

DX³ RCBOs

Cat.Nos	Nominal Rating	Number of 17.5 mm modules	MRP* ₹ / Unit	Pack
---------	----------------	---------------------------	---------------	------

RCBOs assembled for AC applications upto 63 A

ISI marked as per IS 12640-2
 Integrated label holder
 Ergonomic design
 Color coded On/Off indication on dolly
 Front face indication for earth leakage fault
 IP 20 protected terminals
 35 sq mm terminals
 Sliding shutters

Double pole 240 V, AC Type

30 mA

4113 22	6	4	3832	1/32
4113 23	10	4	3796	1/32
4113 24	16	4	3674	1/32
4113 25	25	4	3674	1/32
4113 26	32	4	4020	1/32
4113 27	40	4	4784	1/32
4113 28	63	4	5722	1/32

100 mA

4113 29	6	4	4728	1/32
4113 30	10	4	4728	1/32
4113 31	16	4	4550	1/32
4113 32	25	4	4468	1/32
4113 33	32	4	4550	1/32
4113 34	40	4	5236	1/32
4113 35	63	4	6060	1/32

300 mA

4113 36	16	4	4658	1/32
4113 37	25	4	4658	1/32
4113 38	32	4	4658	1/32
4113 39	40	4	5334	1/32
4113 40	63	4	6114	1/32

Four pole 415 V, AC Type

30 mA

4113 88	6	7	5254	1/16
4113 89	10	7	5254	1/16
4113 65	16	7	5178	1/16
4113 66	25	7	5178	1/16
4113 67	32	7	5342	1/16
4113 68	40	7	5442	1/16
4113 69	63	7	6420	1/16

Four pole 415 V, AC Type

100 mA

4113 70	16	7	5786	1/16
4113 71	25	7	5534	1/16
4113 72	32	7	5596	1/16
4113 73	40	7	5758	1/16
4113 74	63	7	6542	1/16

Four pole 415 V, AC Type

300 mA

4113 75	16	7	5904	1/16
4113 76	25	7	5700	1/16
4113 77	32	7	5700	1/16
4113 78	40	7	5814	1/16
4113 79	63	7	6592	1/16

RCBOs compact for AC applications upto 32 A, 6 kA

Conforms to IEC 60947
 Integrated label holder
 Ergonomic design
 Color coded On/Off indication on dolly
 Front face indication for earth leakage fault
 IP 20 protected terminals
 35 sq mm terminals
 Sliding shutters

Double pole 240 V, AC Type

30 mA

4113 90	6	2	4462	1/32
---------	---	---	------	------

DX³ RCBOs

Cat.Nos	Nominal Rating	Number of 17.5 mm modules	MRP* ₹ / Unit	Pack
---------	----------------	---------------------------	---------------	------

Double pole 240 V, AC Type

30 mA

4113 91	10	2	4462	1/32
4113 92	16	2	4462	1/32
4113 93	20	2	4462	1/32
4113 94	25	2	4462	1/32
4113 95	32	2	4684	1/32

300 mA

4113 97	6	2	4588	1/32
4113 98	10	2	4588	1/32
4113 99	16	2	4588	1/32
4114 00	20	2	4588	1/32
4114 01	25	2	4588	1/32
4114 02	32	2	4820	1/32

Double pole 240 V, HPI Type

30 mA

4114 15	25	2	8556	1/32
4114 16	32	2	9044	1/32

Four pole 415 V, AC Type

30 mA

4114 18	10	4	6066	1/16
4114 19	16	4	6066	1/16
4114 20	20	4	6066	1/16
4114 21	25	4	6066	1/16
4111 89	32	4	6066	1/16

Four pole 415 V, AC Type

300 mA

4114 23	10	4	6694	1/16
4114 24	16	4	6694	1/16
4114 25	20	4	6694	1/16
4114 26	25	4	6694	1/16
4112 08	32	4	6694	1/16

Four pole 415 V, A Type

30 mA

4114 28	10	4	6844	1/16
4114 29	16	4	6844	1/16
4114 30	20	4	6844	1/16
4114 31	25	4	6844	1/16
4112 37	32	4	6844	1/16

Four pole 415 V, A Type

300 mA

4114 33	10	4	7334	1/16
4114 34	16	4	7334	1/16
4114 35	20	4	7334	1/16
4114 36	25	4	7334	1/16
4112 42	32	4	7334	1/16

DX³ RCD add on module

For 125 A

Conform to IEC 61009-1
 AC type : detect AC components faults
 Hpi type :detect faults with AC and DC components, increased
 Immunity to false tripping
 For mounting on the right-hand side of 1.5 module per pole DX³ MCBs
 Easy & fast association mechanism
 Terminal cover for locking
 70 sq mm terminals

Double pole 240 V, AC Type

30 mA

4105 68	125 A	4	13444	1
---------	-------	---	-------	---

100 mA

4105 69	125 A	4	15156	1
---------	-------	---	-------	---

300 mA

4105 71	125 A	4	15156	1
---------	-------	---	-------	---

Bold Cat.Nos are products normally available with Legrand (India) Stockists.
Cat.Nos that are not bold - delivery within 4 - 8 weeks from the date of order.
Bold packing quantity is our mandatory packing. Orders to be placed by Legrand (India) Stockist in multiples of the same.



4113 24



4113 94



4111 89



4112 08



4112 42



4105 68



4113 79

* MRP - Maximum Retail Price Inclusive of all taxes.

DX³ RCD add on module

Cat.Nos	Nominal Rating	Number of 17.5 mm modules	MRP* ₹ / Unit	Pack
---------	----------------	---------------------------	---------------	------

Four pole 415 V, AC Type

30 mA

4106 25	125 A	4	21220	1
---------	-------	---	-------	---

100 mA

4106 26	125 A	4	23712	1
---------	-------	---	-------	---

300 mA

4106 29	125 A	4	23712	1
---------	-------	---	-------	---

Double pole 240 V, HPI type

30 mA

4105 78	125 A	6	17110	1
---------	-------	---	-------	---

100 mA

4105 79	125 A	6	19124	1
---------	-------	---	-------	---

300 mA

4105 82	125 A	6	19124	1
---------	-------	---	-------	---

Four pole 415 V, HPI type

30 mA

4106 38	125 A	6	29332	1
---------	-------	---	-------	---

100 mA

4106 39	125 A	6	31044	1
---------	-------	---	-------	---

300 mA

4106 42	125 A	6	31044	1
---------	-------	---	-------	---

DX³ auxiliaries

Auxiliaries common for MCBs, Isolators, RCCBs & RCBOs

Easy & fast fixation on site
On site clip on mounting
Clip on fitting on left side

Cat.Nos	Description	Number of 17.5 mm modules	MRP* ₹ / Unit	Pack
---------	-------------	---------------------------	---------------	------

Signalling auxiliaries

4062 50	Auxiliary changeover switch 6 A	0.5	856	1
4062 52	Fault signalling changeover switch 6 A	0.5	1006	1
4062 64	Changeover + fault signalling switch	1	1618	1

Control auxiliaries

4062 76	Shunt release 12 /48 V AC/DC	1	2346	1
4062 78	Shunt release 110/415 V V AC	1	2346	1
4062 80	Undervoltage release 24/48 V AC/DC	1	2014	1
4062 82	Undervoltage release 230 V AC	1	2014	1

* MRP - Maximum Retail Price Inclusive of all taxes.



4105 78



4062 50



4062 52



4062 78



4062 82

DX³ auxiliaries

Cat.Nos	Description	Number of 17.5 mm modules	MRP* ₹ / Unit	Pack
---------	-------------	---------------------------	---------------	------

Control auxiliaries

4062 86	Pop over voltage release	1	2548	1
4062 90	Motor control 24/48 V AC/DC	1	9732	1
4062 91	Motor control 110/415 V AC	1	9732	1
4062 93	Motor control 24/48 V AC/DC	2	21894	1
4062 95	Motor control 110/415 V AC	2	21894	1
4062 88	Automatic resetter	2	9732	1
4062 89	Automatic resetter with autotest	2	14596	1

Rotary handle

4063 19	Black rotary handle	-	1946	10
4063 20	Yellow/red rotary handle	-	2190	10

Support for padlock

4063 03	Support for padlock till 63 A	-	456	10
---------	-------------------------------	---	-----	----

Sealable screw cover

4063 04	Devices upto 63 A	-	462	10
4063 06	For 80-125 A devices	-	462	10

1/2 module spacing unit

4063 07	1/2 module spacing unit	0.5	172	10
---------	-------------------------	-----	-----	----

5mm padlock

4063 13	5 mm Padlock	-	364	10
---------	--------------	---	-----	----

Manual changover switch

Compact design
Manual switching operation
Easy to assemble
Ergonomic design

For 1 mod/pole devices

4063 14	Manual change-over switch for DP	1	2190	5
4063 15	Manual change-over switch for TP	1	2676	5
4063 16	Manual change-over switch for FP	1	2920	5

Bold Cat.Nos are products normally available with Legrand (India) Stockists. Cat.Nos that are not bold - delivery within 4 - 8 weeks from the date of order. **Bold packing quantity** is our mandatory packing. Orders to be placed by Legrand (India) Stockist in multiples of the same.

DX³ RCD add on module with measurement & metering

Cat.Nos	Nominal Rating	Number of 17.5 mm modules	MRP* ₹ / Unit	Pack
---------	----------------	---------------------------	---------------	------

Conform to IEC 61009-1
Hpi type: detect faults with AC and DC components, increased
Immunity to false tripping
Inbuilt measurement/metering option
Measurement - V, A, F, PF, KWh, KVA, KVAR, THD
Metering - V, A, F, KWh
RS 485 port for remote reading
Di-electric test button inbuilt
Ergonomic test button
Scroll button for easy readings
RLCD display on front facia
For mounting on the right-hand side of 1.5 module per pole DX³ MCBs
Easy & fast association mechanism
70 sq mm terminals

Adjustable metering, four pole 415 V

4106 57	63 A	7	14668	1
4106 58	125 A	7	26630	1

Adjustable measurement

4106 59	125 A	7	29050	1
---------	-------	---	-------	---

DX³ time switches

Cat.Nos	Description	MRP* ₹ / Unit	Pack
---------	-------------	---------------	------

Time switches

Alpharex³ digital time switches

Daily and weekly time switch
Quick and easy programming due to the option to select day blocks, day blocks can be individually set or selected from the blocks Mon-Sun, Mon-Fri or Sat-Sun
Programming with precision to the second
Switch times visible in weekly overview on display

4126 31	AlphaRex ³ D21, 1 channel	4668	1
4126 41	AlphaRex ³ D22, 2 channels	7002	1
4126 34	AlphaRex ³ D21s, 1 channel	5550	1

Alpharex³ digital time switches - Astro

- For switching on/off lights and other electric devices according to the rising/setting of the sun
- With combination function for creating switching programs in which the devices are switched according to astronomical time and/or fixed preset times
- Daily astronomical calculation of the sunrise/sunset times based on the entered location or location coordinates

4126 54	AlphaRex ³ D21 astro, 1 channel	9336	1
4126 57	AlphaRex ³ D22 astro, 2 channels	10736	1

Alpharex³ yearly time switch

- Yearly and weekly time switch with additional astronomical function for all channels
- 84 switching programs per channel, comprising:
 - 28 weekly programs
 - 28 yearly programs
 - 28 special programs (priority program)

4126 29	AlphaRex ³ DY21, 1 channel	25440	1
4126 30	AlphaRex ³ DY22, 2 channels	26174	1

* MRP - Maximum Retail Price Inclusive of all taxes.



4106 57



4126 41



4126 54



4126 57



4126 29



4128 12



4128 14



4125 44

DX³ time switches

Cat.Nos	Description	MRP* ₹ / Unit	Pack
---------	-------------	---------------	------

Programming accessories

4128 72	Data key	1358	1
4128 73	PC adapter for USB port	4626	1

Twilight switches

- Including light sensor
- Wire for light sensor: 2 x 1.5 mm², maximum wire length: 50 m
- LED switching status indicator

4126 23	Luxo switch	6300	1
---------	-------------	------	---

MicroRex analog time switches

In accordance with IEC 60730-1 and 60730-2-7
Manual switching ON/automatic/OFF
Hourly/daily/weekly switching dial with captive segments
Clock precision: +/- 5 min for the daily time switch
-10 °C to +55 °C operating temperature

4128 23	MicroRex T31 Su/Wi – Daily time switch	5892	1
4128 28	MicroRex W31 Su/Wi – Weekly time switch	6304	1

MicroRex analog time switches

4128 12	MicroRex T31 – Daily time switch	4712	1
4128 13	MicroRex QT31 – Daily time switch	5284	1
4128 14	MicroRex W31 – Weekly time switch	5656	1
4127 90	MicroRex QT11 – Daily time switch	3300	1
4127 94	MicroRex QW11 – Weekly time switch	3808	1

Accessory

4128 59	Wall bracket	978	1
---------	--------------	-----	---

DX³ contactors

Power contactors CX³

Conform to IEC/EN 61095
Space for power supply busbar on top (up to 25 A)

4125 44	25 A 2 NO contactor	1896	1
4125 45	40 A 2 NO contactor	3240	1
4125 47	63 A 2 NO contactor	3770	1
4125 48	63 A 2 NC contactor	3770	1
4125 49	40 A 3 NO contactor	5418	1
4125 50	63 A 3 NO contactor	6128	1
4125 51	25 A 4 NO contactor	2240	1
4125 53	40 A 4 NO contactor	5718	1
4125 56	63 A 4 NO contactor	6768	1
4125 57	63 A 4 NC contactor	6834	1

Signalling auxiliaries for contactors

Auxiliary changeover switch

4124 29	For 1 module contactors 16 A to 25 A	2834	1
4124 30	For 2 module contactors 25 A	2846	1
4124 31	For 40 and 63 A contactors	3734	1

Bold Cat.Nos are products normally available with Legrand (India) Stockists. Cat.Nos that are not bold - delivery within 4 - 8 weeks from the date of order. Bold packing quantity is our mandatory packing. Orders to be placed by Legrand (India) Stockist in multiples of the same.

NEW!

DX³ for photovoltaic applications

Cat.Nos	Description	MRP* ₹ / Unit	Pack
---------	-------------	------------------	------

DC MCBs

Breaking capacity 4.5 kA according to EN 60947-2

800 V_{DC} circuit breakers

4144 24	6 A	■	1
4144 25	8 A	■	1
4144 26	10 A	■	1
4144 27	13 A	■	1
4144 28	16 A	■	1
4144 29	20 A	■	1

1000 V_{DC} circuit breakers

4144 46	10 A	■	1
4144 47	13 A	■	1
4144 48	16 A	■	1
4144 49	20 A	■	1
4144 50	25 A	■	1
4144 51	32 A	■	1

Type 2 voltage surge protectors

DC side protection of photovoltaic installations connected to the low voltage network (without energy storage system)
 Conforming to UTE guide C 61-740-51
 Protection in common mode and residual current mode (Y mode) 1
 Consisting of plug-in modules with LED indicator
 Red: modules need to be replaced

Voltage surge protectors

4141 60	600 V= 25KA I _{max}	■	1
4141 51	1000 V 40KA I _{max}	■	1

Plug-in replacement module

4141 90	+/- cassette for voltage surge protector 4141 60	■	1
4141 91	T cassette for voltage surge protector 4141 60	■	1
4141 81	+/- and T cassette for voltage surge protector 4141 51	■	1

DC rotary handle isolating switches

Category of use DC 21B according to EN 60947-3
 Double break contacts

600 V_{DC} isolating switches

4142 61	16 A	■	1
4142 62	25 A	■	1
4142 63	32 A	■	1

1000 V_{DC} isolating switches

4142 81	16 A	■	1
4142 82	25 A	■	1
4142 83	32 A	■	1

Accessories

4063 05	Pole separation divider	■	1
4063 07	Spacing unit 0.5 unit	■	10

■ Price available on request.
 * MRP - Maximum Retail Price Inclusive of all taxes.
 Red Cat.Nos - new products

SURGE PROTECTIVE DEVICES

Solutions for all installations and risk levels

Clear, easily identifiable marking for easier maintenance, design in line with other Legrand modular equipment, well thought features: the new SPDs integrate perfectly in the modular rows of Legrand distribution boards.



Easier to handle: the plug-in modules are easy to replace thanks to the extraction handles.

Status indicator and remote monitoring of information



1 Fault signal contact
 2 Status indicator

Design and marking

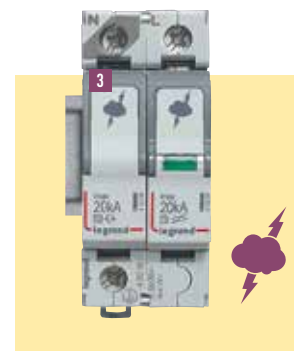

3 Dedicated marking for easier identification and maintenance of the SPDs.

Bold Cat.Nos are products normally available with Legrand (India) Stockists. Cat.Nos that are not bold - delivery within 4 - 8 weeks from the date of order. Bold packing quantity is our mandatory packing. Orders to be placed by Legrand (India) Stockist in multiples of the same.

NEW!

Class I (T1) low voltage SPDs

Cat.Nos	Number of poles	Neutral position	Total (10/350)	Remote status monitoring (FS contact)	Number of modules	LP* ₹ / Unit	Pack
---------	-----------------	------------------	----------------	---------------------------------------	-------------------	--------------	------

SPDs for general protection of main distribution board

T1+T2 - Iimp 12,5 kA/pole T2 - 60 kA

4122 70	1P	-	12.5 kA	No	1	7744	1
4122 76 ¹	1P+N	Right	25 kA	Yes	2	15488	1
4122 71	2P	-	25 kA	No	2	14960	1
4122 72	3P	-	37.5 kA	Yes	3	21076	1
4122 77 ¹	3P+N	Right	50 kA	Yes	4	28240	1
4122 73	4P	-	50 kA	No	4	25852	1

T1+T2 - Iimp 8 kA/pole T2 - 60 kA

4122 50	1P	-	8 kA	No	1	7354	1
4122 56 ¹	1P+N	Right	16 kA	No	2	13376	1
4122 51	2P	-	16 kA	No	2	14212	1
4122 52	3P	-	25 kA	No	3	20020	1
4122 57 ¹	3P+N	Right	25 kA	No	4	24332	1
4122 53	4P	-	32 kA	No	4	25786	1



4122 57

SPDs for high risk level installations

T1 - Iimp 50 kA/pole - 440 V~ (IT) - Monobloc

0030 00 ²	1P	-	50 kA	No	2	7152	1
----------------------	----	---	-------	----	---	------	---

T1 - Iimp 35 kA/pole - 440 V± (IT) - Plug-in

4122 80	1P	-	35 kA	Yes	2	6794	1
---------	----	---	-------	-----	---	------	---

T1 - Iimp 25 kA/pole

4122 81 ¹	1P+N	Right	50 kA	Yes	4	8912	1
4122 82	3P	-	75 kA	Yes	6	46316	1
4122 83 ¹	3P+N	Right	100 kA	Yes	8	50948	1



4122 83

Replacement plug-in modules

Cat.Nos	Description	LP* ₹ / Unit	Pack
---------	-------------	--------------	------

4123 02	For SPDs T1+T2 - 8 kA Cat.Nos 4122 50/ 51/52/53/56/57	5970	1
4123 03	For SPDs T1+T2 - 12.5 kA Cat.Nos 4122 70/ 71/72/73/76/77	5632	1
4122 84	For SPDs T1 - 25 kA Cat.Nos 4122 81/82/83 and 0030 20/22/23/27	16210	1
4122 85	N-PE module for SPDs T1 - 25 kA Cat.Nos 4122 81/83 and 0030 23	22000	1
4122 86	For SPDs T1 - 35 kA Cat.No 4122 80	5438	1



4123 03



4122 84

Cabling accessories

4123 10	Ready to use cabling kit consisting of 5 conductors (including the earth conductor). Cross section :16 mm ² Length : 40 cm For cabling SPDs in industrial enclosures (for EN/IEC 61439 compliance).	1158	1
---------	---	------	---

* LP - List Price Inclusive of excise duty but exclusive of sales tax or any other taxes.

¹ 1P+N and 3P+N: L-N and N-PE protection modes (common and differential modes), the N pole being protected by encapsulated spark gaps. Also called sometimes 1+1 and 3+1

² Replaced mid 2015 by Cat.No 4122 80

Red Cat.Nos - new products

NEW!

Class II (T2) low voltage SPDs

Cat.Nos	Number of poles	Neutral position	Remote status monitoring (FS contact)	Number of modules	LP* ₹ / Unit	Pack
---------	-----------------	------------------	---------------------------------------	-------------------	--------------	------

T2 SPDs

T2 - I_{max} 40 kA/pole

4122 40	1P	-	No	1	5314	1
4122 46 ¹	1P+N	Right	No	2	10120	1
4122 41	2P	-	No	2	10120	1
4122 42	3P	-	Yes	3	14822	1
4122 47 ¹	3P+N	Right	No	4	18040	1
4122 43	4P	-	No	4	18040	1



4122 43

T2 - I_{max} 40 kA/pole - 440 V~ (IT)

4122 30	1P	-	No	1	7040	1
4122 32	3P	-	Yes	3	21076	1
4122 33	4P	-	Yes	4	25852	1

T2 - I_{max} 20 kA/pole

4122 20	1P	-	No	1	3632	1
4122 26 ¹	1P+N	Right	No	2	7920	1
4122 21	2P	-	No	2	7920	1
4122 27 ¹	3P+N	Right	No	4	14740	1
4122 23	4P	-	No	4	14740	1

Replacement plug-in modules

Cat.Nos	Description	LP* ₹ / Unit	Pack
---------	-------------	--------------	------

4122 99	For SPDs T2 - 40 kA Cat.Nos 4122 40/ 41/42/43/44/45/ 46/47/66/67	3844	1
4123 00	N-PE module for SPDs T2 - 40 kA Cat.Nos 4122 46/47	7690	1
4123 01	For SPDs T2 - 440 V Cat.Nos 4122 30/32/33	5914	1
4122 97	For SPDs T2 - 20 kA Cat.Nos 4122 20/ 21/23/26/27/62/63	2904	1
4123 98	N-PE module for SPDs T2 - 20 kA Cat.Nos 4122 24/25/26/27	6206	1



4122 99

Bold Cat.Nos are products normally available with Legrand (India) Stockists. Cat.Nos that are not bold - delivery within 4 - 8 weeks from the date of order. Bold packing quantity is our mandatory packing. Orders to be placed by Legrand (India) Stockist in multiples of the same.

Class II (T2) low voltage SPDs with integrated protection

NEW!

Protection for consumer units

T2 self protected SPDs - I_{max} 12 kA/pole

Cat.Nos	Number of poles	Neutral position	Integrated protection	Number of modules	LP* ₹ / Unit	Pack
0039 51 ¹	1P+N	Left	I _{sc} ≤ 6 kA	2	9834	1
0039 53 ¹	3P+N	Left	I _{sc} ≤ 6 kA	6	21450	1



0039 51



0039 53

Protection for secondary distribution boards

T2 self protected SPDs - I_{max} 12 kA/pole

Cat.Nos	Number of poles	Neutral position	Integrated protection	Number of modules	LP* ₹ / Unit	Pack
0039 71 ¹	1P+N	Left	I _{sc} ≤ 10 kA	2	8140	1
0039 73 ¹	3P+N	Left	I _{sc} ≤ 10 kA	6	15400	1

NEW!

Replacement plug-in modules

Cat.Nos	Description	LP* ₹ / Unit	Pack
0039 54	Cat.Nos 0039 51/53	6380	1
0039 74	Cat.Nos 0039 71/73	6600	1



0039 54

For self protected SPDs

Cat.Nos	Description	LP* ₹ / Unit	Pack
0039 54	Cat.Nos 0039 51/53	6380	1
0039 74	Cat.Nos 0039 71/73	6600	1

For old SPDs

Cat.Nos	Description	LP* ₹ / Unit	Pack
0039 28	Cat.Nos 0039 20/21/22/23	6648	1
0039 34	Cat.Nos 0039 30/31/32/33	5996	1
0039 39	Cat.Nos 0039 35/36/38	5086	1
0039 44	Cat.Nos 0039 40/41/43	4072	1

SPDs for telephone lines

Cat.Nos	In/I _{max}	Max. voltage (UC)	Level of protection (Up)	No. of modules	LP* ₹ / Unit	Pack
0038 28	5/10 kA	170 V	260 V	1	11880	1
0038 29	5/10 kA	48 V	100 V	1	11012	1

SPDs for telephone and data lines

"Analogue" SPD (STN, non-unbundled ADSL, etc.)

0038 28	5/10 kA	170 V	260 V	1	11880	1
---------	---------	-------	-------	---	-------	---

"Digital" SPD (unbundled ADSL, SDSL, ISDN, etc.)

0038 29	5/10 kA	48 V	100 V	1	11012	1
---------	---------	------	-------	---	-------	---



0038 28



0038 29

* LP - List Price Inclusive of excise duty but exclusive of sales tax or any other taxes.

¹ 1P+N and 3P+N: L-N and N-PE protection modes (common and differential modes), the N pole being protected by encapsulated spark gaps. Also called sometimes 1+1 and 3+1

Red Cat.Nos - new products

ZUCCHINI™

Busbar Trunking System

For Industrial, commercial, residential and service sector buildings.

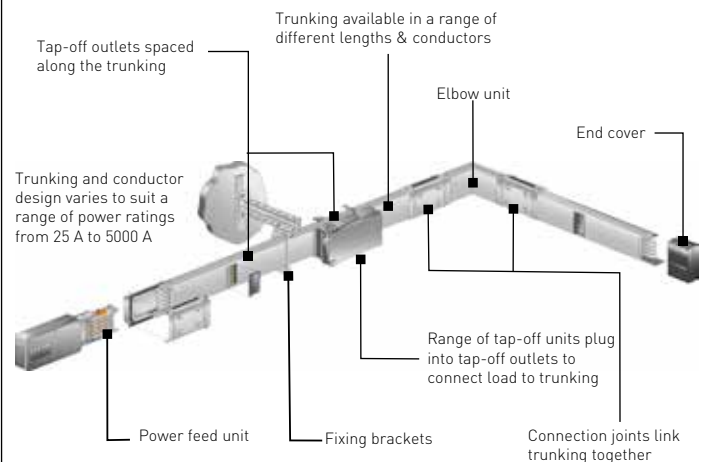

Exclusive features

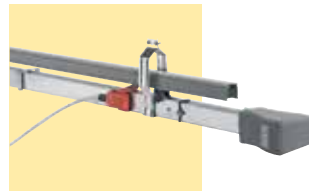

Low Power (25 A, 40 A, 63 A)

- Lighting busway
- 2, 4 & 6 pole
- IP 55 protection
- Tap off units at each 0.5 mt interval
- Copper busbars

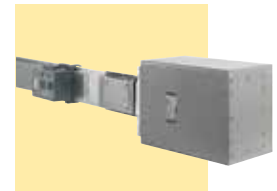

Medium Power (63 A - 1000 A)

- Riser mains application
- IP 40, IP 52, IP 55 protection
- Tap off units at each 1 mt interval
- Aluminium & copper busbars



High Power (1000 A - 5000 A)

- Air insulated type construction
- IP 30/31 protection
- Tap off boxes at each 1 mt interval
- Aluminium & copper busbars



Super Compact (630 A - 5000 A)

- Sandwich type construction
- IP 56 protection
- Tap off boxes at each 1 mt interval
- Aluminium & copper busbars

discover more on : www.zucchinispa.it



for product enquires and prices please contact Legrand personnel

Bold Cat.Nos are products normally available with Legrand (India) Stockists. **Cat.Nos that are not bold** - delivery within 4 - 8 weeks from the date of order. **Bold packing quantity** is our mandatory packing. Orders to be placed by Legrand (India) Stockist in multiples of the same.

DX³ changeover switches

Cat.Nos	Description	LP* ₹ / Unit	Pack
---------	-------------	--------------------	------

Changeover Switches

Single pole - two way - 250 V AC

4129 00	32 A	3128	10/100
---------	------	------	--------

Double pole - two way - 400 V AC

4129 01	32 A	3128	5/50
---------	------	------	------

Double pole - two way with centre off - 400 V AC

4129 03	32 A	3274	5/50
---------	------	------	------

Four pole - two way with centre off - 400 V AC

6040 22	40 A	4806	2/20
---------	------	------	------

DX³ push button

Push button cum switch

Push button cum switch - 1 module - 20 A-250 V AC

Single function

4129 08	Contact 1 NO	2728	10/100
4129 09	Contact 1 NC	2728	10/60
4129 10	Contact 2 NO	2728	10/60

Dual function

4129 14	Contact - 1 NO + green indicator	2728	10/100
4129 15	Contact - 1 NC + red indicator	2728	10/60

DX³ indicators

Single indicators - 1 module - 250 V AC

Possible to replace E10 lamps and diffusers.
E10 - 1.2 Watt, 230 V AC

4129 26	Colour - Green	682	10/100
4129 27	Colour - Red	682	10/100
4129 28	Colour - Orange	682	10/100
4129 29	Colour - Blue	682	10/100
4129 32	White + White + White	1366	10/100
4129 33	Red + Red + Red	1366	10/100
4129 34	Red + Yellow + Green	1366	10/100
4129 35	Red + Yellow + Blue	1366	10/100

Lexic dimmer

Dimmer

1000 W remote dimmer

0036 71	1000 W universal remote control dimmer 6 module	40466	1/10
---------	---	-------	------

Lexic time switches

Multifunction time delay relay

- Supply voltage : 12 to 230 V AC 50/60 Hz and DC
- Output : 8 A - 250 V AC, $\cos\phi = 1$
- Contact NO

0047 44	Multifunction time delay relay	12756	1
---------	-----------------------------------	-------	---

*LP - List Price Inclusive of excise duty but exclusive of sales tax or any other taxes.

Red Cat.Nos - new products

Rex modular time switches

Cat.Nos	Description	LP* ₹ / Unit	Pack
---------	-------------	--------------------	------

Time lag switch

0047 02	Time lag switch long time (1 module)	6612	10/100
---------	---	------	--------

Rex surface mounting time switches

MaxiRex

6499 15	MaxiRex 4QT (daily)	5294	1/30
6499 14A	MaxiRex 4QTB (daily with IP 53 box)	6112	1
6499 39	MaxiRex 5QW (weekly)	5822	1/30
6499 36A	MaxiRex 4QWB (weekly with IP 53 box)	7134	1

EconoRex

0499 86	EconoRex MQT (24 hrs.)	5574	1/30
---------	------------------------	------	------

Accessories

0498 32	Clip on support frame for facia mounting of MaxiRex QTT and QWT	364	1/5
0044 09	DIN rail adaptor for MaxiRex QTT and QWT	272	1
0044 07	DIN rail adaptor for EconoRex BQTAP	266	1
6499 49	Terminal cover for 4/5 nominal time switch	266	1/30
6499 48	IP53 box for MaxiRex 4 and 5	818	1/10

Lexic ammeters

Analogue ammeter

Measures the intensity of the current circulating in an electrical circuit in Amperes (A)

0046 02	Direct connection to alternating or direct current range : 0 - 30 A (4 modules)	5650	1/12
0046 00	Connected using a 5 A current transformer (CT) the meter is fitted with an appropriate dial for the intensity of the current being measured (4 modules)	5650	1/12

Measuring dials for ammeter Cat.No 0046 00

0046 10	0 - 50 A	332	2/84
0046 13	0 - 100 A	332	2/84
0046 15	0 - 200 A	332	2/84
0046 17	0 - 300 A	332	2/84
0046 18	0 - 400 A	332	2/84
0046 20	0 - 600 A	332	2/84
0046 21	0 - 800 A	332	2/84
0046 22	0 - 1000 A	332	2/84

Current transformers

- Used with ammeters
- Supply a current of 0 to 5 A to the secondary which is proportional to the primary current.
- Fix to plate or rail EN 50022

0046 31	50/5 Precision in % - 3 Power in VA - 2	2576	1/12
0046 34	100/5 Precision in % - 1 Power in VA - 2	3440	1/12

Bold Cat.Nos are products normally available with Legrand (India) Stockists. Cat.Nos that are not bold - delivery within 4 - 8 weeks from the date of order. Bold packing quantity is our mandatory packing. Orders to be placed by Legrand (India) Stockist in multiples of the same.

Lexic ammeters

Cat.Nos	Description	LP* ₹ / Unit	Pack
---------	-------------	-----------------	------

Current transformers

0046 36	200/5 Precision in % - 1 Power in VA - 4	3564	1/12
0047 75	300/5 Precision in % - 1 Power in VA - 8	3394	1/12
0046 38	400/5 Precision in % - 1 Power in VA - 12	3564	1/12
0047 76	600/5 Precision in % - 1 Power in VA - 15	3616	1/12
0047 77	800/5 Precision in % - 1 Power in VA - 12	5296	1/12
0047 78	1000/5 Precision in % - 1 Power in VA - 12	5596	1/12
0047 79	1200/5 Precision in % - 1 Power in VA - 15	6530	1/12

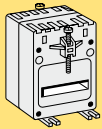
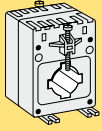

Lexic voltmeters

Analogue voltmeter

Used to measure the AC or DC voltage (V) in an electrical circuit

0046 60	Range 0-500 V - 4 M ▲	5930	1/12
---------	-----------------------	------	------



0046 63

Digital ammeter / voltmeter

0046 63	0-1200 A, 0-500 V	14904	1
---------	-------------------	-------	---

Lexic selector switches

Selector switches

For manual switching of circuits being measured

4-position ammeter selector switch

0046 50	For measuring currents in a 3-phase circuit using only 1 ammeter with a current transformer - 3 M ▲	6200	1/20
---------	---	------	------

4-position voltmeter selector switch

0046 52	For measuring phase-to-phase voltages of a 3-phase circuit without neutral using only 1 voltmeter - 3 M ▲	5690	1/20
---------	---	------	------



0046 52

7-position voltmeter selector switch

0046 53	For measuring phase-to-phase voltages and phase-neutral voltages of a 3-phase circuit with neutral - 3 M ▲	6000	1/20
---------	--	------	------



0046 53

Ekinox³ reinvented energy distribution



Ekinox³

**Ekinox³ reinvented
electrical safety**

Refer p. 52-55

With Ekinox³, we've pushed best to a better level. While others have designed countless variations of distribution boards, no one has really understood the need and complexities of projects with variable power requirements.

*LP - List Price Inclusive of excise duty but exclusive of sales tax or any other taxes.

▲ M = Module

Bold Cat.Nos are products normally available with Legrand (India) Stockists. Cat.Nos that are not bold - delivery within 4 - 8 weeks from the date of order. Bold packing quantity is our mandatory packing. Orders to be placed by Legrand (India) Stockist in multiples of the same.

Uncompromising performance for motor protection and control

A complete range of devices for the protection and control of motors



CTX³ CONTACTORS AND RTX³ THERMAL RELAYS UP TO 800 A

- Compact size
- High mechanical and electrical endurance for maximum reliability
- 3 pole and 4 pole contactors
- Screw terminals
- Complete range of auxiliaries and accessories



MPX³ MOTOR PROTECTION CIRCUIT BREAKERS UP TO 100 A

- High breaking capacity and type 2 coordination for an optimum service level
- Trip class 10
- Sensitive to phase loss
- Compact size
- Can be fixed on 35 mm DIN rail or using screws
- Easy combination with CTX³ 3 pole contactors
- Complete range of control and signalling auxiliaries and accessories



Ekinox³ reinvented energy distribution

Ekinox³ is an experience unlike any other. Imagine a distribution board built with incredible features which keep you away from the worry of constantly maintaining it. Ekinox³ is designed to work as beautifully as it looks.



Ekinox³ SPN DB's

for DX³ MCB, Isolator, RCCB and RCBO

NEW!

Cat.Nos	Number of ways	No. of modules	MRP* ₹ / Unit	Pack
---------	----------------	----------------	------------------	------

- As per IEC 61439-3
- Suitable for Flush Mounting and Surface Mounting
- With 100 A Copper Busbar
- With Neutral bar, Earthbar and Cable ties for Cable management
- Fully shrouded Neutral bars
- Prefitted masking sheet
- Reversible Door for IP 43 & IP 54 DB's

IP 30 - #IK 08

5076 00	4 way	4	1294	1
5076 01	8 way	8	1622	1
5076 02	12 way	12	1922	1
5076 03	16 way	16	2370	1
5076 04	18 way	18	2760	1
5076 05	20 way	20	2834	1



5076 05

IP 43 - #IK 09 with metal door

5076 10	4 way	4	1738	1
5076 11	8 way	8	2156	1
5076 12	12 way	12	2592	1
5076 13	16 way	16	3254	1
5076 14	18 way	18	3316	1
5076 15	20 way	20	4022	1



5076 12

IP 43 - #IK 09 with acrylic door

5076 20	4 way	4	2220	1
5076 21	8 way	8	2566	1
5076 22	12 way	12	3122	1
5076 23	16 way	16	3880	1
5076 24	18 way	18	4256	1
5076 25	20 way	20	4548	1

IP 54 - #IK 09

5076 40	4 way	4	5828	1
5076 41	8 way	8	6850	1
5076 42	12 way	12	7870	1
5076 43	16 way	16	8754	1
5076 44	18 way	18	9200	1
5076 45	20 way	20	9716	1



5076 42

Ekinox³ ETPN DB's

for DX³ MCB, Isolator, RCCB and RCBO

- As per IEC 61439-3
- Suitable for Flush Mounting and Surface Mounting
- With 100 A Copper Busbar for each phase
- With Neutral bar, Earthbar and Cable ties for Cable management
- Fully insulated busbar & shrouded Neutral bars
- Improved Pan assembly for ease of installation
- Prefitted masking sheet
- Reversible Door for IP 43 & IP 54 DB's
- With provision for FP MCB/Isolator/RCCB/RCBO as incomer and SP MCB's as outgoing
- Supplied with wireset
- Can be converted to PPI DB at site using conversion kit

IP 30 - #IK 08

5076 60	4 way	8+12	3576	1
5076 61	6 way	8+18	4412	1
5076 62	8 way	8+24	5186	1
5076 63	12 way	8+36	7686	1
5076 64	16 way	8+48	9476	1
5076 66	20 way	8+60	13218	1



5076 61

* MRP - Maximum Retail Price Inclusive of all taxes.

#IK - Refer pg - 60 for ready reckoner table.

Red Cat.Nos - new products

Ekinox³ ETPN DB's

for DX³ MCB, Isolator, RCCB and RCBO

NEW!

Cat.Nos	Number of ways	No. of modules	MRP* ₹ / Unit	Pack
---------	----------------	----------------	------------------	------

IP 43 - #IK 09 with metal door

5076 70	4 way	8+12	4252	1
5076 71	6 way	8+18	5244	1
5076 72	8 way	8+24	6286	1
5076 73	12 way	8+36	9418	1
5076 74	16 way	8+48	11678	1
5076 76	20 way	8+60	16348	1



5076 82

IP 43 - #IK 09 with acrylic door

5076 80	4 way	8+12	5526	1
5076 81	6 way	8+18	6824	1
5076 82	8 way	8+24	8186	1
5076 83	12 way	8+36	12554	1
5076 84	16 way	8+48	15066	1
5076 86	20 way	8+60	21092	1

IP 54 - #IK 09

5076 90	4 way	8+12	13886	1
5076 91	6 way	8+18	16710	1
5076 92	8 way	8+24	18276	1
5076 93	12 way	8+36	25758	1
5076 94	16 way	8+48	30910	1
5076 96	20 way	8+60	38674	1

Ekinox³ Flexy DB

for DX³ DIN modular products

Cat.Nos	Number of row	No. of modules	MRP* ₹ / Unit	Pack
---------	---------------	----------------	------------------	------

- As per IEC 61439-3
- Suitable for Flush Mounting and Surface Mounting
- Completely flexible to organise the distribution as per site requirements
- Busbars to be selected as per distribution requirements
- With Neutral and Earth bars
- Fully shrouded Neutral bars
- Improved Pan assembly for ease of installation
- Prefitted masking sheet
- Reversible door for IP 43

IP 30 - #K 08

5077 01	2 row of 14 M	28	4532	1
5077 02	3 row of 14 M	42	5438	1
5077 03	4 row of 14 M	56	6230	1



5077 01

IP 43 - #IK 09 with metal door

5077 05	2 row of 14 M	28	5340	1
5077 06	3 row of 4 M	42	6418	1
5077 07	4 row of 14 M	56	6990	1
5077 12	3 row of 14 M MCCB for DPX ³ 160 MCCB	42	7056	1



5077 11

IP 43 - #IK 09 with acrylic door

5077 09	2 row of 14 M	28	5648	1
5077 10	3 row of 14 M	42	6932	1
5077 11	4 row of 14 M	56	7848	1
5077 13	3 row of 14 M MCCB for DPX ³ 160 MCCB	42	8320	1

Bold Cat.Nos are products normally available with Legrand (India) Stockists. Cat.Nos that are not bold - delivery within 4 - 8 weeks from the date of order. Bold packing quantity is our mandatory packing. Orders to be placed by Legrand (India) Stockist in multiples of the same.

Ekinox³ TPN DB-VTPN DB's

for DX³ MCB, Isolator, RCCB and RCBO

NEW!

Cat.Nos	Number of ways	No. of modules	MRP* ₹ / Unit	Pack
---------	----------------	----------------	---------------	------

- As per IEC 61439-3
- Suitable for Flush Mounting and Surface Mounting
- With 100 A Copper Busbar for each phase
- With 2 Neutral bar, 2 Earthbar and Cable ties for Cable management
- Fully insulated busbar & shrouded Neutral bars
- Improved Pan assembly for ease of installation
- Prefitted masking sheet
- Reversible Door for IP 43 & IP 54 DB's
- With provision for FP MCB/Isolator/RCCB/RCBO as incomer and SP/TP MCB's as outgoing



5077 20

IP 30 - #IK 08

5077 20	4 way	8+12	9970	1
5077 21	6 way	8+18	10968	1
5077 22	8 way	8+24	12174	1
5077 23	12 way	8+36	17582	1

IP 43 - #IK 09 with metal door

5077 25	4 way	8+12	10482	1
5077 26	6 way	8+18	11530	1
5077 27	8 way	8+24	13334	1
5077 28	12 way	8+36	17940	1

IP 43 - #IK 09 with acrylic door

5077 30	4 way	8+12	14198	1
5077 31	6 way	8+18	15618	1
5077 32	8 way	8+24	18048	1
5077 33	12 way	8+36	24082	1



5077 31

IP 54 - #IK 09

5077 35	4 way	8+12	22492	1
5077 36	6 way	8+18	24742	1
5077 37	8 way	8+24	27054	1
5077 38	12 way	8+36	36050	1

Ekinox³ TPN DB-VTPN DPX³ 160 MCCB DB's

- As per IEC 61439-3
- Suitable for Flush Mounting and Surface Mounting
- With 250 A Copper Busbar for each phase
- With 2 Neutral bar, 2 Earthbar and Cable ties for Cable management
- Fully insulated busbar & shrouded Neutral bars
- Improved Pan assembly for ease of installation
- Prefitted masking sheet
- Reversible Door for IP 43 & IP 54 DB's
- With provision for DPX³ 160 MCCB as incomer and SP/TP MCB's as outgoing

IP 30 - #IK 08

5077 40	4 way	DPX ³ 160+12	11500	1
5077 41	6 way	DPX ³ 160+18	12420	1
5077 42	8 way	DPX ³ 160+24	13612	1
5077 43	12 way	DPX ³ 160+36	20576	1

IP 43 - #IK 09 with metal door

5077 45	4 way	DPX ³ 160+12	12632	1
5077 46	6 way	DPX ³ 160+18	14352	1
5077 47	8 way	DPX ³ 160+24	15794	1
5077 48	12 way	DPX ³ 160+36	21124	1

* MRP - Maximum Retail Price Inclusive of all taxes.

#IK - Refer pg - 60 for ready reckoner table.

Red Cat.Nos - new products

Ekinox³ TPN DB-VTPN DPX³ 160 MCCB DB's

NEW!

Cat.Nos	Number of ways	No. of modules	MRP* ₹ / Unit	Pack
---------	----------------	----------------	---------------	------

IP 54 - #IK 09

5077 50	4 way	DPX ³ 160+12	25882	1
5077 51	6 way	DPX ³ 160+18	29762	1
5077 52	8 way	DPX ³ 160+24	31112	1
5077 53	12 way	DPX ³ 160+36	41782	1



5077 53

Ekinox³ TPN DB-VTPN DPX³ 250 MCCB DB's

- As per IEC 61439-3
- Suitable for Flush Mounting and Surface Mounting
- With 250 A Copper Busbar for each phase
- With 2 Neutral bar, 2 Earthbar and Cable ties for Cable management
- Fully insulated busbar & shrouded Neutral bars
- Improved Pan assembly for ease of installation
- Prefitted masking sheet
- Reversible Door for IP 43 & IP 54 DB's
- With provision for DPX³ 250 MCCB as incomer and SP/TP MCB's as outgoing

IP 30 - #IK 08

5077 55	4 way	DPX ³ 250+12	20948	1
5077 56	8 way	DPX ³ 250+24	22488	1
5077 57	12 way	DPX ³ 250+36	25064	1



5077 55

IP 43 - #IK 09 with metal door

5077 58	4 way	DPX ³ 250+12	23386	1
5077 59	8 way	DPX ³ 250+24	27308	1
5077 60	12 way	DPX ³ 250+36	28780	1

IP 54 - #IK 09

5077 61	4 way	DPX ³ 250+12	36490	1
5077 62	8 way	DPX ³ 250+24	41210	1
5077 63	12 way	DPX ³ 250+36	48256	1

Ekinox³ TPN DB-Phase selector DB's for DX³ MCB, Isolator, RCCB and RCBO

- As per IEC 61439-3
- With inbuilt 3 nos of 63 A Phase selector switches and 3 Nos Piano Switches
- Suitable for Flush Mounting and Surface Mounting
- With 100 A Copper Busbar for each phase
- With Neutral bar, Earthbar and Cable ties for Cable management
- Fully insulated busbar & shrouded Neutral bars
- With provision for FP MCB/Isolator/RCCB/RCBO as incomer and SP MCB's as outgoing
- Supplied with wire set

IP 30 - #IK 08

5077 70	4 way	8+12	13920	1
5077 71	6 way	8+18	14806	1
5077 72	8 way	8+24	16402	1
5077 73	12 way	8+36	18010	1



5077 81

IP 43 - #IK 09 with metal door

5077 80	4 way	8+12	15056	1
5077 81	6 way	8+18	15298	1
5077 82	8 way	8+24	16390	1
5077 83	12 way	8+36	18452	1

Bold Cat.Nos are products normally available with Legrand (India) Stockists. Cat.Nos that are not bold - delivery within 4 - 8 weeks from the date of order. Bold packing quantity is our mandatory packing. Orders to be placed by Legrand (India) Stockist in multiples of the same.

Ekinox³ TPN DB - 7 segment DB's for DX³ MCB, Isolator, RCCB and RCBO

NEW!

Cat.Nos	Number of ways	No. of modules	MRP* ₹ / Unit	Pack
---------	----------------	----------------	---------------	------

- As per IEC 61439-3
- Separate compartment for incomer, sub-incomer & outgoing devices
- Suitable for Flush Mounting and Surface Mounting
- With 100 A Copper Busbar for each phase
- With Neutral bar, Earthbar and Cable ties for Cable management
- Fully insulated busbar & shrouded Neutral bars
- With provision for FP MCB/Isolator/RCCB/RCBO as incomer and SP MCB's as outgoing
- Supplied with wire set
- DB with phase segmentation and separation between incomer and Outgoings

IP 30 - #IK 08

5078 80	4 way	8+12+12	10114	1
5078 81	6 way	8+12+18	10874	1
5078 82	8 way	8+12+24	11816	1
5078 83	12 way	8+12+36	13600	1

IP 43 - #IK 09 with metal door

5078 85	4 way	8+12+12	11150	1
5078 86	6 way	8+12+18	12560	1
5078 87	8 way	8+12+24	14026	1
5078 88	12 way	8+12+36	17438	1

Ekinox³ TPN DB - 7 segment DB's for 160 A DPX³ MCCB

- As per IEC 61439-3
- DB with phase segmentation and separation between incomer and Outgoings
- Suitable for Flush Mounting and Surface Mounting
- With 100 A Copper Busbar for each phase
- With Neutral bar, Earthbar and Cable ties for Cable management
- Fully Color Shrouded Insulated bus bar and Neutral bars
- With provision for DPX³ 160 MCCB as incomer DP MCB/Isolator/RCCB/RCBO as sub incomers and SP MCB's as outgoing
- Supplied with wire set

IP 30 - #IK 08

5078 90	4 way	DPX ³ 160+12+12	14456	1
5078 91	6 way	DPX ³ 160+12+18	16632	1
5078 92	8 way	DPX ³ 160+12+24	19114	1
5078 93	12 way	DPX ³ 160+12+36	22190	1

* MRP - Maximum Retail Price Inclusive of all taxes.
#IK - Refer pg - 60 for ready reckoner table.
Red Cat.Nos - new products

Ekinox³ TPN DB - 7 segment DB's for 160 A DPX³ MCCB

NEW!

Cat.Nos	Number of ways	No. of modules	MRP* ₹ / Unit	Pack
---------	----------------	----------------	---------------	------

IP 43 - #IK 09 with metal door

5078 95	4 way	DPX ³ 160+12+12	15920	1
5078 96	6 way	DPX ³ 160+12+18	18220	1
5078 97	8 way	DPX ³ 160+12+24	20864	1
5078 98	12 way	DPX ³ 160+12+36	23762	1

Ekinox³ Metra plug & socket DB's for DX³ MCB, RCCB and RCBO

Cat.Nos	Description	No. of modules	MRP* ₹ / Unit	Pack
---------	-------------	----------------	---------------	------

- As per IEC 61439-3
- Suitable for Flush Mounting and Surface Mounting
- Suitable for protection of appliances like AC/Geyser etc
- Supplied with Neutral Links
- With provision for mounting modular devices

#IK 08

5078 10	10 A SP, 2P+E	1	1720	1
5078 11	20 A SP, 2P+E	1	1850	1
5078 14	20 A DP, 2P+E	2	2012	1
5078 17	20 A TP, 3P+E	3	3410	1
5078 18	32 A TP, 3P+E	3	4046	1
5078 20	20 A DP RCBO, 2P+E	4	1950	1
5078 21	20 A FP RCBO, 2P+E	8	3406	1
5078 22	32 A FP RCBO, 3P+E	8	4016	1

Ekinox³ P-17 Tempra plug & socket DB's for DX³ MCB, RCCB and RCBO

- As per IEC 61439-3
- Suitable for Flush Mounting and Surface Mounting
- Supplied with Neutral Links
- With provision for mounting modular devices

#IK 08

5078 60	16 A 2P+E-DP	2	2840	1
5078 63	32 A 2P+E-DP	2	3064	1
5078 61	32 A 3P+E-FP	8	4294	1
5078 62	32 A 3P+N+E-FP	8	5580	1
5078 64	63 A 3P+N+E-FP	8	14196	1

Bold Cat.Nos are products normally available with Legrand (India) Stockists. Cat.Nos that are not bold - delivery within 4 - 8 weeks from the date of order. Bold packing quantity is our mandatory packing. Orders to be placed by Legrand (India) Stockist in multiples of the same.

Ekinox³ Metal enclosures

for DX³ MCB, RCCB, RCBO and DPX³ MCCB's

NEW!

Cat.Nos	Description	No. of modules	MRP* ₹ / Unit	Pack
---------	-------------	----------------	---------------	------

- As per IEC 61439-3
- For independent mounting of DX³ MCB, RCCB, RCBO, DPX³ 160, DPX³ 250, DPX³ 630 & DRX MCCB's
- #IK 08

#IK 08

5077 90	SP enclosure	1	460	1
5077 91	DP enclosure	2	672	1
5077 92	TP enclosure	3	672	1
5077 93	FP enclosure	4	672	1
5077 94	FP RCBO enclosure	8	1138	1

Metal one way enclosures for MCCB

5078 01	DPX ³ 160 MCCB enclosure	3&4	3866	1
5078 02	DPX ³ 250 MCCB enclosure	3&4	6866	1
5078 04	DPX ³ 630 MCCB enclosure	3&4	10408	1
5078 05	DRX 100 MCCB enclosure-TP	3&4	2066	1

Ekinox³ cable end box

Cat.Nos	Description	MRP* ₹ / Unit	Pack
---------	-------------	---------------	------

- Useful for keeping extra cables
- Possible to mount on the top or bottom of the DB
- Provision for mounting terminal blocks
- Can be used as a terminal box adaptor also

For IP 30 DB's

5079 10	For SPN 4 W IP30	656	1
5079 12	For SPN 8 W IP30	762	1
5079 14	For SPN 12 W/ VTPN/Flexy	844	1
5079 16	For SPN 16 W/ ETPN 6 way DB	1190	1
5079 21	For ETPN 4 way DB	1144	1
5079 23	For ETPN 6 way DB	1190	1
5079 25	For ETPN 8 way DB	2126	1
5079 27	For ETPN 12 way DB	2832	1
5079 29	For ETPN 16 way DB	2832	1
5079 31	For ETPN 18 way DB	3114	1
5079 33	For ETPN 20 way DB	3114	1
5079 35	For all VTPN/FLEXY MCB	844	1
5079 37	For all VTPN MCCB DBS	3130	1

For IP 43 DB's

5079 11	For SPN 4 way DB	762	1
5079 13	For SPN 8 way DB	876	1
5079 15	For SPN 12 way/ VTPN/Flexy DB	984	1

* MRP - Maximum Retail Price Inclusive of all taxes.

#IK - Refer pg - 60 for ready reckoner table.

Red Cat.Nos - new products

NEW!

Ekinox³ cable end box

Cat.Nos	Description	MRP* ₹ / Unit	Pack
---------	-------------	---------------	------

For IP 43 DB's

5079 17	For SPN 16 way/ ETPN 6 way DB	1392	1
5079 18	For SPN 18 way DB	1426	1
5079 19	For SPN 20 way DB	1460	1
5079 22	For ETPN 4 way DB	1268	1
5079 24	For ETPN 6 way DB	1392	1
5079 26	For ETPN 8 way DB	2440	1
5079 28	For ETPN 12 way DB	3254	1
5079 30	For ETPN 16 way DB	3254	1
5079 32	For ETPN 18 way DB	3576	1
5079 34	For ETPN 20 way DB	3576	1
5079 36	For all VTPN/Flexy MCB	984	1
5079 38	For all VTPN MCCB DBs	3524	1

Ekinox³ DBs

meter box

- Suitable for Mounting DX³ Metering products
- Possible to mount on the top or bottom of the DB
- Provision for mounting Ammeter/Voltmeter/ASS/VSS
- #IK09

Provision for mounting meters

5079 40	For VTPN MCB INCOM IP 30	4264	1
5079 41	For VTPN MCB INCOM IP 43	5116	1
5079 42	For VTPN MCCB INCOM IP 30	4738	1
5079 43	For VTPN MCCB INCOM IP 43	5684	1

Per phase Isolation kit

5079 44	PPI conversion kit for ETPN 4 way DB	2448	1
5079 45	PPI conversion kit for ETPN 6 way DB	2756	1
5079 46	PPI conversion kit for ETPN 8 way DB	3292	1
5079 47	PPI conversion kit for ETPN 12 way DB	3558	1
5079 48	PPI conversion kit for ETPN 16 way DB	3998	1

Panel locks

5079 52	Panel knob for IP 43	276	1
5079 51	Panel knob with key	586	1

Bold Cat.Nos are products normally available with Legrand (India) Stockists. Cat.Nos that are not bold - delivery within 4 - 8 weeks from the date of order. Bold packing quantity is our mandatory packing. Orders to be placed by Legrand (India) Stockist in multiples of the same.

5077 91

5077 93

5079 43

5079 12

5079 16

5079 27

Ekinox™ distribution boards

Cat.Nos	Number of ways	No. of modules	LP* ₹ / Unit	Pack
---------	----------------	----------------	-----------------	------

SPN DBs

For DX³/MCB, Isolator, RCCB and RCBO
IP 20 - #IK 08

6077 00	4 way	4	1294	1
6077 01	8 way	8	1622	1
6077 02	12 way	12	1922	1
6077 03	16 way	16	2370	1

6077 00

IP 43 - #IK 09 with metal door

6077 10	4 way	4	1738	1
6077 11	8 way	8	2156	1
6077 12	12 way	12	2592	1
6077 13	16 way	16	3254	1
6077 24	18 way	18	3316	1

6077 10

IP 43 - #IK 09 with acrylic door

6077 20	4 way	4	2220	1
6077 21	8 way	8	2566	1
6077 22	12 way	12	3122	1
6077 23	16 way	16	3880	1

6077 20

IP 54 - #IK 09

6077 30	4 way	4	5828	1
6077 31	8 way	8	6850	1
6077 32	12 way	12	7870	1
6077 33	16 way	16	8754	1

6077 30

TPN DBs - ETPN DBs

For DX³/MCB, Isolator, RCCB and RCBO
With provision for FP MCB/Isolator/RCCB/RCBO as
incomer and SP MCBs as outgoing
Can be converted to PPI DB at site by
using conversion kit (refer p. 60)

IP 20 - #IK 08

6077 05	4 way	8+12	3576	1
6077 06	6 way	8+18	4412	1
6077 07	8 way	8+24	5186	1
6077 08	12 way	8+36	7686	1
6077 09	16 way	8+48	9476	1

6077 07

IP 43 - #IK 09 with metal door

6077 15	4 way	8+12	4252	1
6077 16	6 way	8+18	5244	1
6077 17	8 way	8+24	6286	1
6077 18	12 way	8+36	9418	1
6077 19	16 way	8+48	11678	1

6077 17

IP 43 - #IK 09 with acrylic door

6077 25	4 way	8+12	5526	1
6077 26	6 way	8+18	6824	1
6077 27	8 way	8+24	8186	1
6077 28	12 way	8+36	12554	1
6077 29	16 way	8+48	15066	1

6077 27

IP 54 - #IK 09

6077 35	4 way	8+12	13886	1
6077 36	6 way	8+18	16710	1
6077 37	8 way	8+24	18276	1
6077 38	12 way	8+36	25758	1
6077 39	16 way	8+48	30910	1

6077 37

*LP - List Price Inclusive of excise duty but exclusive of sales tax or any other taxes.

#IK - Refer pg - 60 for ready reckoner table.

Ekinox™ distribution boards

Cat.Nos	Number of ways	No. of modules	LP* ₹ / Unit	Pack
---------	----------------	----------------	-----------------	------

TPN DBs - 7 segment DBs

For DX³/MCB, Isolator, RCCB and RCBO
With provision for FP MCB/Isolator/RCCB/RCBO
as incomer, DP MCB/Isolator/RCCB/RCBO
as subincomer and SP MCBs as outgoing

IP 20 - #IK 08

6078 25	4 way	8+12+12	10942	1
6078 26	6 way	8+12+18	11916	1
6078 27	8 way	8+12+24	12756	1
6078 28	12 way	8+12+36	14828	1



6078 25

IP 42 - #IK 09 with metal door

6078 35	4 way	8+12+12	11010	1
6078 36	6 way	8+12+18	12414	1
6078 37	8 way	8+12+24	13718	1
6078 38	12 way	8+12+36	17418	1



6078 35

TPN DBs - 7 segment DBs

Common for DX³/MCB, Isolator and RCD

Cat.Nos	Number of ways	LP* ₹ / Unit	Pack
---------	----------------	-----------------	------

With phase segregation and separation
between incoming and outgoing.

IP 20 protection

6014 50 G	4	10114	1
6014 51 G	6	10874	1
6014 52 G	8	11816	1
6014 53 G	12	13600	1



6014 52 G

IP 42 protection - metal door

6014 54 G	4	11150	1
6014 55 G	6	12560	1
6014 56 G	8	14026	1
6014 57 G	12	17438	1

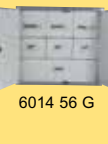

6014 56 G

TPN DBs - Phase selector DBs

For DX³/MCB, Isolator, RCCB and RCBO

Cat.Nos	Number of ways	No. of modules	LP* ₹ / Unit	Pack
---------	----------------	----------------	-----------------	------

With provision for FP MCB/Isolator/RCCB/RCBO
as incomer and SP MCBs as outgoing with inbuilt
3 nos. of 63 A phase selector switches and 3 nos.
piano switches

IP 20 - #IK 08

6078 65	4 way	8+12	13920	1
6078 66	6 way	8+18	14806	1
6078 67	8 way	8+24	16402	1
6078 68	12 way	8+36	18010	1



6078 66

IP 42 - #IK 09 with metal door

6078 75	4 way	8+12	15056	1
6078 76	6 way	8+18	15298	1
6078 77	8 way	8+24	16390	1
6078 78	12 way	8+36	18452	1



6078 76

Bold Cat.Nos are products normally available with Legrand (India) Stockists.
Cat.Nos that are not bold - delivery within 4 - 8 weeks from the date of order.
Bold packing quantity is our mandatory packing. Orders to be placed by
Legrand (India) Stockist in multiples of the same.

Ekinox™ distribution boards

Cat.Nos	Number of ways	No. of modules	LP* ₹ / Unit	Pack
---------	----------------	----------------	-----------------	------

TPN DBs - VTPN DBs

For DX³/MCB, Isolator, RCCB and RCBO

With provision for FP
MCB/Isolator/RCCB/RCBO
as incomer and SP / TP MCBs as outgoing till 63 A

IP 20 - #IK 08

6077 40	4 way	8+12	9970	1
6077 41	8 way	8+24	12174	1
6077 42	12 way	8+36	17582	1

IP 43 - #IK 09 with metal door

6077 50	4 way	8+12	10482	1
6077 51	8 way	8+24	13334	1
6077 52	12 way	8+36	17940	1

IP 43 - #IK 09 with acrylic door

6077 60	4 way	8+12	14198	1
6077 61	8 way	8+24	18048	1
6077 62	12 way	8+36	24082	1

IP 54 - #IK 09

6077 70	4 way	8+12	22492	1
6077 71	8 way	8+24	27054	1
6077 72	12 way	8+36	36050	1

7 Segment DPX³ MCCB DBs

for DX³/MCB, Isolator, RCCB and RCBO

IP 20 - IK 08

6079 28	4 way	DPX ³ 160+ 12+12	14456	1
6079 30	6 way	DPX ³ 160+ 18+12	16632	1
6079 31	8 way	DPX ³ 160+ 24+12	19114	1
6079 32	12 way	DPX ³ 160+ 36+12	22190	1

TPN DBs - 7 segment DPX³ MCCB DBs

for DX³/MCB, Isolator, RCCB and RCBO

IP 42 - IK 09 with metal door

6079 33	4 way	DPX ³ 160+ 12+12	15920	1
6079 34	6 way	DPX ³ 160+ 18+12	18220	1
6079 35	8 way	DPX ³ 160+ 24+12	20864	1
6079 36	12 way	DPX ³ 160+ 36+12	23762	1

TPN DBs - DPX³ 160 MCCB DBs for DX³/MCB

IP 20 - IK 08

6079 10	4 way	DPX ³ 160+12	11500	1
6079 11	8 way	DPX ³ 160+24	13612	1
6079 12	12 way	DPX ³ 160+36	20576	1

*LP - List Price Inclusive of excise duty but exclusive of sales tax or any other taxes.

#IK - Refer pg - 60 for ready reckoner table.

Red Cat.Nos - new products

Ekinox™ distribution boards

Cat.Nos	Number of ways	No. of modules	LP* ₹ / Unit	Pack
---------	----------------	----------------	-----------------	------

TPN DBs - DPX³ 160 MCCB DBs for DX³/MCB till 63 A as outgoing

IP 43 - IK 09 with metal door

6079 13	4 way	DPX ³ 160+12	12632	1
6076 95	6 way	DPX ³ 160+18	14352	1
6079 14	8 way	DPX ³ 160+24	15794	1
6079 15	12 way	DPX ³ 160+36	21124	1

IP 54 - IK 09

6079 16	4 way	DPX ³ 160+12	25882	1
6079 17	8 way	DPX ³ 160+24	31112	1
6079 18	12 way	DPX ³ 160+36	41782	1

TPN DBs - DPX³ 250 MCCB DBs for DX³/MCB till 63 A as outgoing

IP 20 - IK 08

6079 19	4 way	DPX ³ 250+12	20948	1
6079 20	8 way	DPX ³ 250+24	22488	1
6079 21	12 way	DPX ³ 250+36	25064	1

IP 43 - IK 09 with metal door

6079 22	4 way	DPX ³ 250+12	23386	1
6079 23	8 way	DPX ³ 250+24	27308	1
6079 24	12 way	DPX ³ 250+36	28780	1

IP 54 - IK 09

6079 25	4 way	DPX ³ 250+12	36490	1
6079 26	8 way	DPX ³ 250+24	41210	1
6079 27	12 way	DPX ³ 250+36	48256	1

Flexy DB

For DX³ modular products

IP 20 - #IK 08

6077 45	2 row of 13 modules	26	4532	1
6077 55	3 row of 13 modules	39	5438	1
6077 65	4 row of 13 modules	52	6230	1

IP 43 - #IK 09 with metal door

6077 46	2 row of 13 modules	26	5340	1
6077 56	3 row of 13 modules	39	6418	1
6077 66	4 row of 13 modules	52	6990	1
6077 68	8 modules 4 row	32	6458	1
6077 69	10 modules 4 row	40	6698	1
6076 96	13 modules 4 row DPX ³ 160 MCCB	52	7056	1

IP 43 - #IK 09 with acrylic door

6077 47	2 row of 13 modules	26	5648	1
6077 57	3 row of 13 modules	39	6932	1
6077 67	4 row of 13 modules	52	7848	1

Bold Cat.Nos are products normally available with Legrand (India) Stockists. Cat.Nos that are not bold - delivery within 4 - 8 weeks from the date of order. Bold packing quantity is our mandatory packing. Orders to be placed by Legrand (India) Stockist in multiples of the same.

Ekinox™ distribution boards

Cat.Nos	Number of ways	LP* ₹ / Unit	Pack
---------	----------------	--------------	------

Plexo³ boxes for DX³

Self-extinguishing: resistance to incandescent wire 650 °C
 Conform to EN 60439-3
 Weatherproof cabinets - IP 65 - IK 09 - Class II
 Door and cabinet fully reversible
 Removable chassis and faceplates from 2-row versions up
 2-position rail for modular products and moulded cases
 Spacing between rails 150 mm
 Box colour light grey L750A, cover colour dark grey R746A



6019 94

6019 32	2 (+1) Module	1620	1
6019 94	4 Module	1728	1
6019 96	6 Module	1980	1
6019 98	8 Module	2474	1



6018 32

Cabinets with 12 modules per row

6018 31	1 row 12 modules	3900	1
6018 32	2 rows 24 modules	5408	1
6018 33	3 rows 36 modules	7540	1

Cabinets with 18 modules per row

6018 35	18 modules x 1 row	4812	1
6018 36	18 modules x 2 rows	8320	1
6018 37	18 modules x 3 rows	11700	1
6018 38	18 modules x 4 rows	18204	1



6018 32 + 0019 17

Multifunction sleeves for P17

0019 17	For 2 row cabinets	3122	1
0019 18	For 3 row cabinets	4680	1
0019 67	Joining kit	910	1

Metra plug and socket DBs

For DX³/MCBs, RCCBs & RCBOs

With provision for SP/DP/TP MCB

Cat.Nos	Number of ways	No. of modules	LP* ₹ / Unit	Pack
6078 40	10 A SP	1	1720	1
6078 41	20 A SP	1	1850	1
6078 43	20 A DP	2	2012	1
6078 50	20 A TP	3	3410	1
6078 51	32 A TP	3	4046	1



6078 40



6078 60



6078 61

With provision for DP/FP RCCBs / RCBOs

6078 60	20 A DP RCBO	4	1950	1
6078 61	20 A FP RCBO	8	3406	1
6078 62	32 A FP RCBO	8	4016	1

P17 tempra plug and socket DBs

For DX³ / MCBs / RCCBs / RCBOs

6078 70	16 A 2P+E-DP	2	2840	1
6078 73	32 A 2P+E-DP	2	3064	1
6078 71	32 A 3P+E-FP	8	4294	1
6078 72	32 A 3P+N+E-FP	8	5580	1
6078 80	63 A 3P+N+E-FP	8	14196	1



6078 72

*LP-List Price Inclusive of excise duty but exclusive of sales tax or any other taxes.

Ekinox™ distribution boards

Cat.Nos	Number of ways	No. of modules	LP* ₹ / Unit	Pack
---------	----------------	----------------	--------------	------

Metal one way enclosures

For DX³ / MCBs / RCCBs / RCBOs / MCCBs

For independent mounting of MCBs/RCCBs/RCBOs/MCCBs

6078 81	SP Enclosure	1	460	1
6078 82	DP Enclosure	2	672	1
6078 83	TP Enclosure	3	672	1
6078 84	FP Enclosure	4	672	1
6078 85	FP RCBO enclosure	8	1138	1
6079 05	DRX 100 MCCB enclosure	3P	2066	1
6079 06	DRX 100 MCCB enclosure	4P	2066	1
6079 44	DPX ³ 160 enclosure MCCB	3P & 4P	3866	1
6079 45	DPX ³ 250 MCCB enclosure	3P & 4P	6866	1
6079 03	DPX 250 MCCB enclosure	3P & 4P	8220	1
6079 04	DPX 630 MCCB enclosure	4P	10408	1



6078 81



6078 84



6078 85

Plastic enclosures for DX³

For independent mounting of MCBs / RCDs / Isolators

Cat.Nos	Number of ways	LP* ₹ / Unit	Pack
0013 56	For 2 poles	202	1
0013 57	For 4 poles	288	1
0013 58	For 6 poles	452	1



Cable end box

For IP 20 DBs

6077 43	For SPN 4 way DB	656	1
6077 53	For SPN 8 way DB	762	1
6077 63	For SPN 12 way DB	844	1
6077 73	For SPN 16 way DB	1190	1
6077 83	For ETPN 4 way DB	1144	1
6077 73	For ETPN 6 way DB	1190	1
6077 93	For ETPN 8 way DB	2126	1
6078 03	For ETPN 12 way DB	2832	1
6078 03	For ETPN 16 way DB	2832	1
6077 63	For all VTPN MCB DB	844	1
6078 13	For all VTPN DPX ³ MCCB DBs	3130	1
6077 63	For all Flexy DBs	844	1



6077 43

For IP 43 DBs

6077 44	For SPN 4 way DB	762	1
6077 54	For SPN 8 way DB	876	1
6077 64	For SPN 12 way DB	984	1
6077 74	For SPN 16 way DB	1392	1
6077 84	For ETPN 4 way DB	1268	1
6077 74	For ETPN 6 way DB	1392	1
6077 94	For ETPN 8 way DB	2440	1



6077 44

Bold Cat.Nos are products normally available with Legrand (India) Stockists. Cat.Nos that are not bold - delivery within 4 - 8 weeks from the date of order. Bold packing quantity is our mandatory packing. Orders to be placed by Legrand (India) Stockist in multiples of the same.

Ekinox™ distribution boards

Cat.Nos	Number of ways	LP* ₹ / Unit	Pack
---------	----------------	--------------	------

Cable end box

For IP 43 DBs

6078 04	For ETPN 12 way DB	3254	1
6078 04	For ETPN 16 way DB	3254	1
6077 64	For all VTPN MCB DB	984	1
6078 14	For all VTPN DPX ³ MCCB DBs	3524	1
6077 64	For all Flexy DBs	984	1

Meter box

Provision for mounting Ammeter/Voltmeter/
Ammeter selector switch/ Voltmeter selector switch



6077 75

6077 75	For all VTPN DPX ³ MCCB IP 20 DB	4738	1
6077 76	For all VTPN DPX ³ MCCB IP 43 DBs	5684	1
6077 77	For all VTPN DPX ³ MCCB IP 54 DBs	6602	1

Per phase isolation kit

6078 90	PPI conversion kit for ETPN 4 way DB	2448	1
6078 91	PPI conversion kit for ETPN 6 way DB	2756	1
6078 92	PPI conversion kit for ETPN 8 way DB	3192	1
6078 93	PPI conversion kit for ETPN 12 way DB	3558	1
6078 94	PPI conversion kit for ETPN 16 way DB	3998	1

Panel locks



6078 95

6078 95	Panel lock for IP 43 SPN DBs	440	1
6078 96	Panel lock for IP 54 SPN DBs	470	1
6078 97	Panel lock for IP 43 ETPN, VTPN MCB, DPX ³ MCCB & Flexy DBs	586	1
6078 98	Panel lock for IP 54 ETPN, VTPN MCB, DPX ³ MCCB & Flexy DBs	618	1

*LP - List Price Inclusive of excise duty but exclusive of sales tax or any other taxes.

Distribution boards

Cat.Nos	No. of devices connected	No. of 17.5 mm modules	LP* ₹ / Unit	Pack
---------	--------------------------	------------------------	--------------	------

Supply busbars - insulated

100 A copper

Pin type

SP I/C & SP O/G

4049 26	13	13	316	1
4049 37	57	57	1226	1

SPN I/C & SPN O/G

4049 38	6	12	556	1
4049 39	28	56	2290	1

TPN I/C & SPN O/G

4049 40	5	12	574	3/30
4049 41	27	56	5596	5/10

TP I/C & TP O/G

4049 42	4	12	574	1
4049 43	19	57	5652	1

FP I/C & FP O/G

4049 44	3	12	1378	3/30
4049 45	14	56	5596	5/10

Fork type

SP I/C & SP O/G

4049 11	13	12	316	1
4049 12	57	57	1200	1

SPN I/C & SPN O/G250

4049 14	28	56	2290	1
---------	----	----	------	---

TP I/C & TP O/G

4049 17	4	12	574	1
4049 18	19	57	5596	1

FP I/C & FP O/G

4049 20	14	56	5596	5/10
---------	----	----	------	------

Cat.Nos	Description	LP* ₹ / Unit	Pack
---------	-------------	--------------	------

Accessories for fork and pin type busbars

4049 89	End caps for SP	8	6
4049 90	End caps for DP & TP	34	6
4049 91	End caps for FP	68	20/840

Cat.Nos	Number of ways	LP* ₹ / Unit	Pack
---------	----------------	--------------	------

Blanking plates

6014 70 G	-	18	10
-----------	---	----	----

Bold Cat.Nos are products normally available with Legrand (India) Stockists. Cat.Nos that are not bold - delivery within 4 - 8 weeks from the date of order. Bold packing quantity is our mandatory packing. Orders to be placed by Legrand (India) Stockist in multiples of the same.

Ekinox³

For converting ETPN DB to PPI DB

PPI DB IP 30 - IK 08

No. of ways	Combine		No. of modules
	ETPN DB	PPI Kit	
4 way	4 way 507660	4 way kit 507944	8+12
6 way	6 way 507661	6 way kit 507945	8+18
8 way	8 way 507662	8 way kit 507946	8+24
12 way	12 way 507663	12 way kit 507947	8+36
16 way	16 way 507664	16 way kit 507948	8+48

PPI DB IP 43 - IK 09 with metal door

No. of ways	Combine		No. of modules
	ETPN DB	PPI Kit	
4 way	4 way 507670	4 way kit 507944	8+12
6 way	6 way 507671	6 way kit 507945	8+18
8 way	8 way 507672	8 way kit 507946	8+24
12 way	12 way 507673	12 way kit 507947	8+36
16 way	16 way 507674	16 way kit 507948	8+48

PPI DB IP 43 - IK 09 with acrylic door

No. of ways	Combine		No. of modules
	ETPN DB	PPI Kit	
4 way	4 way 507680	4 way kit 507944	8+12
6 way	6 way 507681	6 way kit 507945	8+18
8 way	8 way 507682	8 way kit 507946	8+24
12 way	12 way 507683	12 way kit 507947	8+36
16 way	16 way 507684	16 way kit 507948	8+48

PPI DB IP 54 - IK 09

No. of ways	Combine		No. of modules
	ETPN DB	PPI Kit	
4 way	4 way 507690	4 way kit 507944	8+12
6 way	6 way 507691	6 way kit 507945	8+18
8 way	8 way 507692	8 way kit 507946	8+24
12 way	12 way 507693	12 way kit 507947	8+36
16 way	16 way 507694	16 way kit 507948	8+48

IK

Protection against mechanical impact: protection index - IK

According to standard:

IEC 62262, BS EN 62262 and NF EN 62262

• This table can be used to ascertain the resistance of a product to an impact given in Joules from the IK code (graduated from 00 to 10)

It can also be used to ascertain the correspondence with the old IP code 3rd digit and the corresponding external "Ag" conditions

IK	Tests	Impact energy (in Joules)	"AG" of NF C 15-100
IK 00		0	
IK 01		0.15	
IK 02		0.2	AG1
IK 03		0.35	
IK 04		0.5	
IK 05		0.7	
IK 06		1	
IK 07		2	AG2
IK 08		5	AG3
IK 09		10	
IK 10		20	AG4

IPXX

Index of protection

IP*** index of protection of enclosures of electrical equipment in accordance with standards IEC 529, BS 5490, DIN 400 50 and NF C 20-010

Up to 1000 V± and 1500 V= (standard UTE C 20 010)

1st figure:- protection against solid bodies

IP	tests	
0		No protection
1		Protected against solid bodies larger than 50 mm (eg:- accidental contact with the hand)
2		Protected against solid bodies larger than 12 mm (eg:- finger)
3		Protected against solid bodies larger than 2.5 mm (eg:- tools, wires)
4		Protected against solid bodies larger than 1 mm (eg:- fine tools and small wires)
5		Protected against dust (no harmful deposit)
6		Completely protected against dust

2nd figure:- protection against liquids

IP	tests	
0		No protection
1		Protected against vertically-falling drops of water (condensation)
2		Protected against drops of water falling at up to 15° from the vertical
3		Protected against drops of rain water at up to 60° from the vertical
4		Protected against projections of water from all directions
5		Protected against jets of water from all directions
6		Protected against jets of water of similar force to heavy seas
7		Protected against the effects of immersion
8		Protected against prolonged effects of immersion under pressure

The contents of all the above charts are for guidance only, if you have any doubt as to the interpretation of the information contained therein, please refer either to the standard itself or contact Legrand.

In accordance with our policy of continuous improvement, Legrand reserves the right to change specifications and designs without notice. All information given here is correct at the time of going to press.

Legrand training centres

Delhi • Kolkata • Mumbai • Pune • Chennai • Hyderabad

Product Display Centres

• Jaipur • Guwahati • Nagpur • Indore • Vijaywada



- Balanced methodology with focus on theory and practical sessions.
- Dedicated training programs as per market requirement.
- Live demonstration of the products for better understanding of its features and applications

Please visit the Mumbai Showroom to experience the complete range



To enrol for a training, please contact your Legrand Area Manager

Arteor™ is the innovative answer to the increasingly complex requirements in the building business all over the world. Arteor™ excels by its unique aesthetics and a rich choice of innovative designs and ergonomical options.



The range extends from wiring devices, through innovative radio automation solutions, up to fully networked home automation systems based on BUS technology, which can also be integrated into third party solutions.

Arteor™

versatility and a global vision for any installation level





_ Design options for control functions

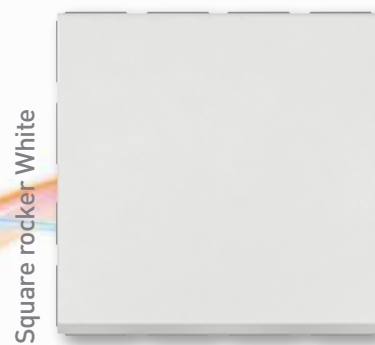
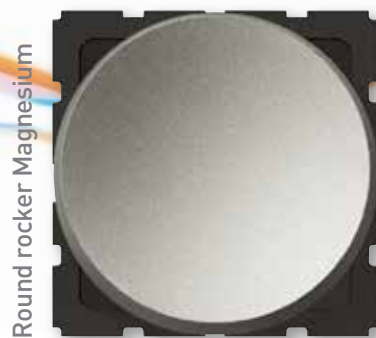

Arteor™ offers a wide choice of ergonomics and finishes to satisfy the most demanding customers. All stand-alone control functions are available in two shapes of rockers – round or square – and in two colours – white or magnesium.

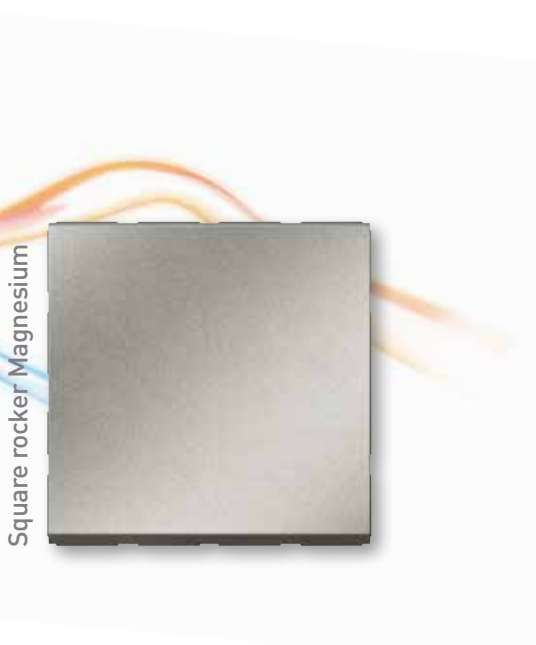

Arteor™ design for a global lifestyle

The timeless design of Arteor™ features clearly hi-tech characteristics understandable anywhere in the world. Minimalist and sober, its carefully crafted design is inspired by the most modern technological devices, such as flat screens and digital photo frames, creating the impression that the product is floating on the wall.



Switch & socket

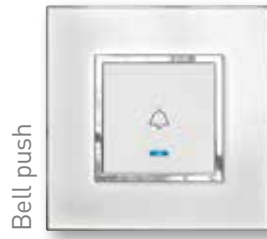

Bell push



Fan regulator



TV socket



1-way switch - 3 gang



Skirting light



Power unit

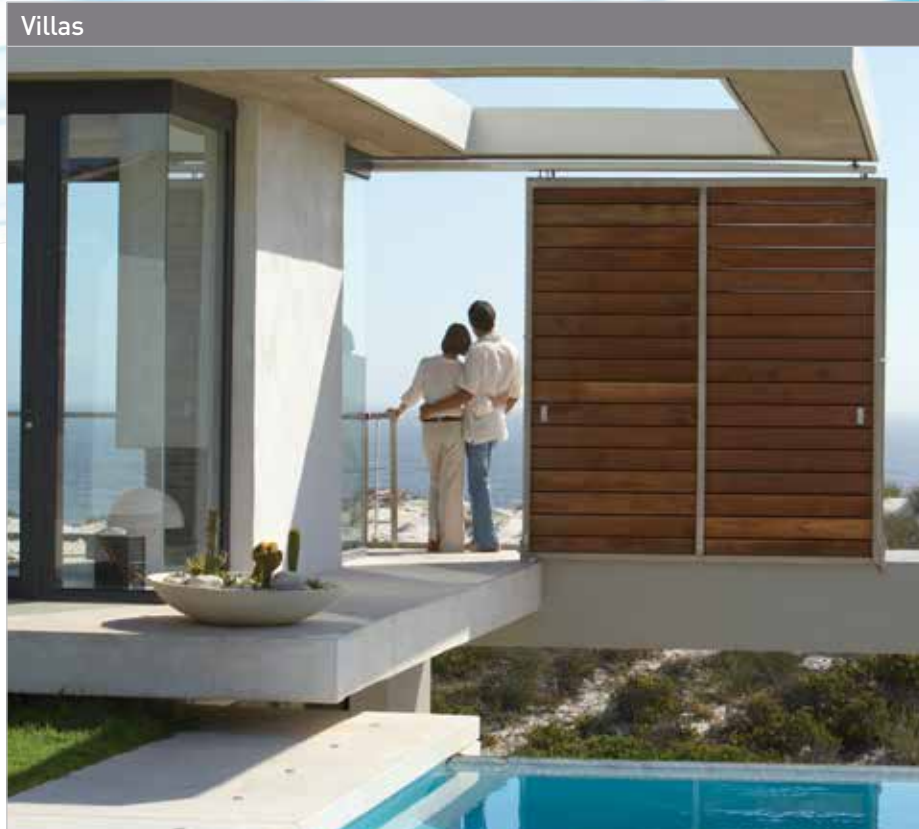

Villas



Time delay switch



6AX switch



Leading \ trailing edge dimmer

Homes



Arteor™

the ideal solution,
always and
everywhere

Its versatility makes Arteor™ the ideal choice for every kind of project, anywhere in the world at any installation level. Arteor™ suits any requirement in terms of design and function for every kind of building, from residential to commercial.

Triple RCA socket



Skirting light



USB charger



Automatic switch



HDMI



USB



RJ45



Female HD15 + Jack



Fingerprint reader



Coded keypad reader



Hotels



4-Scenario touch control



S-Video socket



Keycard switch



External unit



Internal unit



TV/R/SAT



Offices



Arteor™ office and hotel solutions

Desk and
entrance light



Bed light and
curtain switch



Data sockets





MY HOME
 legrand

The answer for all home automation requirements,
from a single function to global integrated solutions.
My Home Legrand supports 2 technologies :
Radio using ZigBee® protocol and BUS using SCS protocol.

* for more details contact us

Arteor™ home automation overview

This comprehensive and versatile home automation solution, which is integrated to the Arteor™ line will satisfy your most demanding customers' needs



NEUTRAL



TATTOO



MIRROR



MIRROR



GRAPHIC



GRAPHIC



BRUSHED METAL



WOOD



LEATHER



LEATHER



SIGNATURE





Arteor™

a rich choice of finishes

A wide range of finishes and materials for perfect harmony with modern environments, whether residential or commercial.

Features that set ARTEOR™ apart



- ① Finger-proof terminals for IP 20 protection against accidental contact.
- ② Captive "never to loose screws".



- ① Tunnel terminals preventing screwdrivers from slipping.
- ② Laser marking on mechanisms. Arrow showing the correct orientation of the mechanism.
- ③ The latest IS 3854 : 1997.

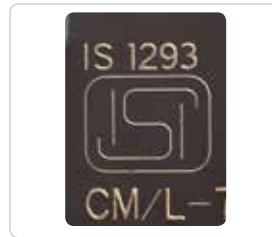

Sockets with ISI mark, conforming to IS 1293. Fan regulator with ISI mark, conforming to IS 11037.



Fully shrouded internal mechanism under the rocker preventing visibility of sparks.



- ① Stripping templates on sockets for stripping off exact length of insulation.



Sockets are shuttered for child's safety against electric shocks.



Possibility of weather proofing mechanisms using Plexo IP 55 and IP 66 boxes.



For switches with LED lamps, life of LED is 50000 burning hours. Consumes power (0.76 W) next to NIL.

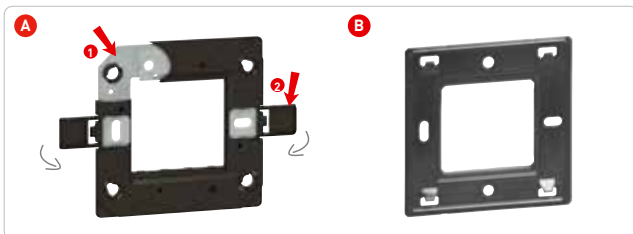

A. For all high end plates

- ① Metal frame providing solid support to base. Bi-material frame - electrical safety IP20.
- ② Screw caps can be closed once the support frame is installed, ensuring total insulation.

B. For white plates only.



2x2 way switch - 3 controls possible in 2 module plate. In round and square design possible.

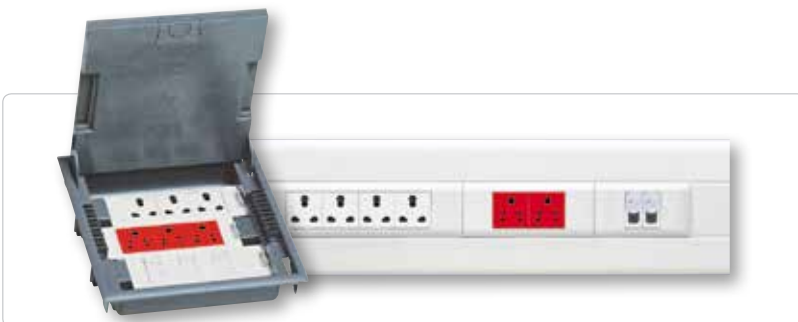

Mechanisms compatible with DLP trunking systems, columns, floor boxes and VDI installations.

Protection at every step of the installation process



Support frames and plates are each supplied with special shrink wrap protection should be removed only once site work is fully completed.

Arteor™

versatility and modularity for unrivalled flexibility

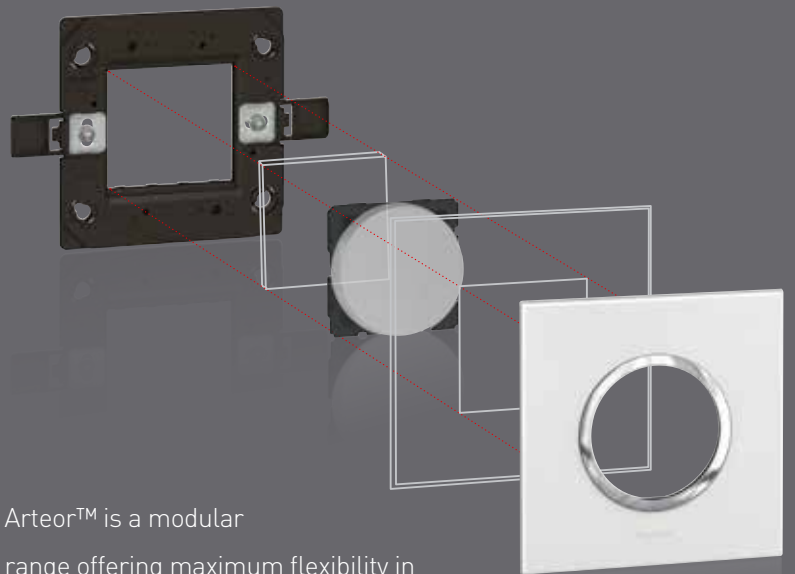

Arteor™ is a modular range offering maximum flexibility in terms of installation and configuration.

Arteor™ square - white mechanisms

Cat.Nos	Description	MRP* ₹ / Unit	Pack
---------	-------------	------------------	------

Switches – 6 A - 250 V AC

5734 00	Switch - 6 A - SP - 1 way 1 module	166	20/200
5734 01	Switch - 6 A - SP - 1 way with indicator - 1 module	250	20/200
5734 02	Switch - 6 A - SP - 2 way 1 module	220	20/200
5734 03	Switch - 6 A - SP - 2 way with indicator - 1 module	316	20/200

Switches – 10 A - 250 V AC

5734 50	Switch - 10 A - SP - 1 way 2 module	256	10/100
5734 51	Switch - 10 A - SP - 2 way 2 module	302	10/100
5720 37	Switch - 10 A - SP - 2 way with indicator & label holder - 2 module	1440	10/100
5720 38	Intermediate switch - 2 module	1722	10/100

Switches – 20 A - 250 V AC

5734 10	Switch - 20 A - SP - 1 way - 1 module	292	20/200
5734 52	Switch - 20 A - SP - 1 way - 2 module	348	10/100
5720 63	Switch - 20 A - SP - 1 way with indicator - 1 module	300	20/200
5734 11	Switch - 20 A - SP - 2 way with indicator - 1 module	420	20/200
5720 42	Switch - 20 A - SP - 2 way with indicator - 2 module	460	10/100
5720 43	Switch - 20 A - 3 gang - 1 way - 2 module	824	10/100
5720 44	Switch - 20 A - 3 gang - 2x2 way + 1x1 way - 2 module	904	10/100
5734 54	Switch - 20 A - DP - 1 way with indicator - 2 module	650	10/100
5720 49	Switch - 20 A - DP - 1 way with indicator and water heater marking - 2 module	684	10/100

Accessory for switch with indicator

5738 06	LED for switch with indicator (blue)	54	5/50
5738 05	LED for switch with indicator (red)	46	5/50

Switches – 25 A - 230 V AC

5734 17	25 A switch with indicator	394	20/200
---------	----------------------------	-----	--------

Switches – 32 A / 40 A - 250 V AC

5734 12	Switch - 32 A - DP - 1 way with indicator - 2 module	928	10/100
5735 30	Switch - 40 A - DP - 1 way with indicator - fits on 1/2 module box	1072	1/5/20

Push button – 6 A - 250 V AC

5734 13	Bell push - 6 A - SP - 1 way - 1 module	238	20/200
5734 59	Bell push - 6 A - SP - 1 way - 2 module	332	10/100
5734 04	Push button - 6 A - SP - 1 way - 1 module	250	20/200
5734 05	Push button - 6 A - SP - 1 way with indicator - 1 module	318	20/200
5734 14	Bell push - 6 A - SP - 1 way with indicator - 1 module	316	20/200
5734 60	Bell push - 6 A - SP - 1 way with indicator - 2 module	446	10/100

Electric roller blinds control

5722 20	Double switch for electric shutter - 2 module	580	10/100
---------	--	-----	--------

* MRP - Maximum Retail Price Inclusive of all taxes.
Red Cat.Nos - new products
■ Price available on request.

Arteor™ square - white mechanisms

Cat.Nos	Description	MRP* ₹ / Unit	Pack
---------	-------------	------------------	------

Dimmers and fan regulators

5734 62	Light dimmer 60 to 400 watts 2 module	956	1/10/100
5734 16	Fan step regulator 100 watts - 1 module	770	1/5/50
5734 63	Fan step regulator 100 watts - 2 module	946	1/10/100
5734 69	Fan step regulator 120 watts - 2 module (for 48 & 56" fans)	1010	1/10/100
5734 68	Fan step regulator 2 module for energy saving fans	1006	1/10/100

Electronic touch dimmer

5734 65	Universal touch dimmer 3 M	6000	1/10
---------	-------------------------------	------	------

Indian standard sockets

5734 70	Socket shuttered - 6 A - 2/3 pin - universal India 2 module	288	20/200
5734 71	Socket shuttered - 6/16 A - 3 pin - Indian - 2 module	384	10/100
5734 67	Socket shuttered - 6/16 A - 3 pin - Indian - 3 module	464	5/50
5734 72	Socket - 13 A - 3 pin - 2P+E BS - 2 module	600	10/100
5735 10	Socket with switch - 16 A - 3 pin - 2P+E - Indian - 3 module	1088	5/50
5721 04	Socket - 15/16 A - 2P - Euro/US - 1 module	390	10/100
5737 79	Socket - 6 A/13 A/15 A for 127 V, - double multistandard - 4 module	666	5/50
5734 73	Multistandard socket - 6/10/13 A - 2/3 pin for 250 V AC 15 A for 127 V type - 2 pin 2 module	362	10/100
5734 66	25 A socket - 2 module	468	10/100
5721 16	Euro/US - 15 A - 127 V/16 A - 250 V, 2P + E with shutter 2 module	540	10/100

Energy plugs

5738 86	6 A plug	170	1/10/100
5738 88	16 A plug	222	1/10/100
5738 07	25 A plug	252	1/10/100

USB chargers (IS13252 (Part 1) / IEC 60950-1)

5734 21	USB Charger 1M 1000mA	1264	10/100
5734 22	Double USB Charger 2M 2400mA	2012	1/10/100

RJ 11 telephone sockets (Jack type)

5734 27	Telephone socket - double RJ11 - 1 module	340	20/200
5734 26	Telephone socket - RJ11 with shutter - 1 module	200	20/200

Information outlets - toolless

5734 29	Information socket - category 5e-UTP - 1 module	472	20/200
5734 75	Information socket - category 5e-UTP - 2 module	504	10/100
5734 28	Information socket - category 6-UTP - 1 module	720	20/200
5734 74	Information socket - category 6-UTP - 2 module	756	10/100
5734 32	Information socket - 10G - STP - 1 module	■	20/200

Bold Cat.Nos are products normally available with Legrand (India) Stockists.
Cat.Nos that are not bold - delivery within 4 - 8 weeks from the date of order.
Bold packing quantity is our mandatory packing. Orders to be placed by
Legrand (India) Stockist in multiples of the same.

Arteor™ square - white mechanisms

Cat.Nos	Description	MRP* ₹ / Unit	Pack
---------	-------------	------------------	------

Information outlets - toolless

5734 30	Information socket - category 5e-FTP - 1 module	■	20/200
5734 76	Information socket - category 6-FTP - 2 module	■	10/100
5734 34	Information socket - category 6-STP - 1 module	■	20/200
5734 77	Information socket - category 6-STP - 2 module	■	10/100

TV sockets

5734 25	TV Co-Axial socket - 1 module	208	20/200
---------	-------------------------------	-----	--------

Electronic chime

5734 43	Bell ding dong 230V - 2 module	316	1/10/100
---------	--------------------------------	-----	----------

Buzzer

5734 42	Buzzer - 230 V - 1 module	1118	20/200
---------	---------------------------	------	--------

Bell call indicator & register - 6A - 250V AC

5734 15	Bell call indicator with register - 6 A - 1 way - SP - 1 module	1394	20/200
5736 06	Set of labels for bell call indicator (1-20)	366	5/50

Lighting

5734 64	Skirting light with LED - 230 V - 3 module	752	1/5/25
5722 26	Skirting light with detector (LED) - 230 V - 2 module	15744	1/20
5722 22	Miniature emergency light unit - 2 module	7564	1/20
5724 53	Over door light unit (Red) 2 module	418	10/100
5722 23	Over door light unit (White) 2 module	342	10/100
5724 52	Indicator unit with transparent LED with coloured labels - 1 module	560	10/100

Power strip and power units

5737 80	Set of 3 multistandard socket + Switch pre-wired - 8 module	1948	1/10
5735 42 ⁽¹⁾	Power unit (AC & Geyser) 16 A - 4 module	1232	1/5
5721 54	Power unit (AC & Geyser) 32 A (with cable output)	1386	1/5

MCB

5723 61	MCB - 16 A-SPN - 2 module	3190	1
---------	---------------------------	------	---

RCBO

5734 85	RCBO - 16 A-SPN - 2 module	10876	1
---------	----------------------------	-------	---

Protectors

5734 40	Surge protector - 1 module	3318	20/200
5734 48	Surge protector - 2 module	3882	10/100

* MRP - Maximum Retail Price Inclusive of all taxes.

Red Cat.Nos - new products

(1) Supplied with white plate

■ Price available on request

Arteor™ square - white mechanisms

Cat.Nos	Description	MRP* ₹ / Unit	Pack
---------	-------------	------------------	------

Hotel "DND and MMR" functions

5734 61	DND and MMR indicator with bell push 1+1 module	1498	5/50
5734 58	Internal control unit for DND & MMR 1+1 module	1078	10/100

Hotel keycard switch

5722 30	Key card switch 230 V 2 module	4768	1/20
	+		
5722 27	Single pole latching relay 2 module	3716	1/20
5722 59	Key fob for above	1116	10/50

Shaver socket

5721 53	Shaver socket 230 V / 120 - 230 V with earth connector	4262	1
---------	--	------	---

Infrared sensors

5740 47	PIR sensor with neutral 2 module	8172	1/20
5740 34	PIR sensor without neutral - 2 module	7284	1/20

Keycode switch

5722 52 ⁽¹⁾	Keycode switch	23746	1/10
------------------------	----------------	-------	------

Time switch

5720 55	Time delay switch 2 module	5382	1/20
---------	----------------------------	------	------

Audio-video sockets

5722 72	Double RCA socket (audio) 1 module	■	1/20
5722 73	Triple RCA socket (audio & video) 1 module	■	1/20
5722 74	Female 3.5 mm Jack - 1 module	■	1/20
5722 76	Female BNC 75 jack - 1 module	■	1/20
5722 83	Female XLR jack - 2 module	■	1/20
5723 70	Kit HD 15 + jack amplified transceiver	■	1
5722 82	Female HD15 (VGA) - 2 module	■	1/20
5720 97	Preterminated sockets Female HD15 - 1 module	■	1
5722 81	HDMI socket - 2 module	■	1/20
5720 96	Preterminated sockets HDMI 1.4 - 1 module	■	1
5722 84	Line dying down 100 V (25-30W) 2 module	■	1
5722 77	Male XLR jack 2 module	■	1/20
5722 78	Female 3.5 mm Jack - solder - 1 module	■	1/20
5722 75	USB socket - 1 module	■	1/20
5722 79	Female HD15 (VGA) solder - 1 module	■	1/20
5744 01	S-VIDEO socket - 1 module	■	1/40
5722 88	Female HD15 + Jack 3.5 mm - 2 module	■	1/20

Bold Cat.Nos are products normally available with Legrand (India) Stockists. Cat.Nos that are not bold - delivery within 4 - 8 weeks from the date of order. Bold packing quantity is our mandatory packing. Orders to be placed by Legrand (India) Stockist in multiples of the same.

Arteor™ square - white mechanisms

Cat.Nos	Description	MRP* ₹ / Unit	Pack
Electronic dimmers			
5735 01	Rotary dimmer 1000 W - 2 module to be equipped with 5760 01	■	1/10
5740 07	Dimmer 2x400 W all load - 2 module (supplied with support frame)	■	1/10
5740 06	Dimmer 600 W all load - 2 module to be equipped with 5760 01	■	1/10
5722 11	R-I touch dimmer without neutral 600 W - 2 module to be equipped with 5760 01	■	1/10
5722 39	Universal dimmer without neutral 400 W - 2 module	■	1/10
5760 01#	Support frame 3 module - for 5722 11/5740 06/5735 01	■	5

Microswitches

5720 51	Switch without contact 2 way 230 V - 2 module	■	1/10
5740 00	Universal micro-switch with neutral 2x1000 W with leds status 2 Way - 2 module	■	1/10
5740 01	Universal micro-switch with neutral 3x1000 W with leds status 2 Way - 2 module	■	1/10
5740 02	All-load micro-switch without neutral 2x400 W with leds status 2 Way - 2 module	■	1/10
5740 03	Universal micro-switch with neutral 1000 W with leds status 2 Way - 2 module	■	1/10

Splitters and access point

5723 36	Wiring splitter Ethernet/Tel FTP LCS - 1 module	■	10/100
5723 35	Wiring splitter Ethernet/Tel UTP LCS - 1 module	■	10/100
5723 32	RJ45 rear pluggable Cat5e FTP white LCS - 2 module	■	10/100
5723 30	RJ45 rear pluggable Cat5e UTP white LCS - 2 module	■	10/100
5723 33	RJ45 rear pluggable Cat6 FTP white LCS - 2 module	■	10/100
5723 31	RJ45 rear pluggable Cat6 UTP white LCS - 2 module	■	10/100
5723 76	Access point for WIFI POE A+Bg + jack - 4 module	■	1/10

Splitters and access point

5723 77	Access point for WIFI A+Bg - 4 module	■	1/10
5723 78	Access point for WIFI bg - 4 module	■	1/10

* MRP - Maximum Retail Price Inclusive of all taxes
Red Cat.Nos - new products
 # Special plate for support frame available on request
 ■ Price available on request

Arteor™ square - white mechanisms

Cat.Nos	Description	MRP* ₹ / Unit	Pack
Cable outlet			
5734 80	45 A cable outlet 2 module	836	5/50
5734 33	Cord outlet with 8 mm diameter - 1 module	266	20/200
5734 79	Standard cord outlet - 2 module	382	10/100

Blanking plate

5734 49	1 module blank	42	20/200
5723 44	2 modules blank	60	10/100
5758 10	Blanking plate + frame - 2 module	356	10/100

Mounting accessories for panel

5760 15	Panel mounting support - 1 module	218	10/100
5760 16	Panel mounting support - 2 module	228	10/100
5760 50	DIN rail support 2 module	272	10/100

Square - magnesium mechanisms

Switches - 6 A - 250 V AC

5736 00	Switch - 6 A-SP - 1 way - 1 module	186	20/200
5736 01	Switch - 6 A-SP - 1 way with indicator - 1 module	284	20/200
5736 02	Switch - 6 A-SP - 2 way - 1 module	256	20/200
5736 03	Switch - 6 A-SP - 2 way with indicator - 1 module	366	20/200

Switches - 10 A - 250 V AC

5736 50	Switch - 10 A-SP - 1 way - 2 module	272	10/100
5736 51	Switch - 10 A-SP - 2 way - 2 module	324	10/100
5725 37	Switch - 10 A-SP - 2 way with indicator & label holder - 2 module	1618	10/100
5725 38	Intermediate switch - 2 module	1982	10/100

Switches - 20 A - 250 V AC

5736 10	Switch - 20 A-SP - 1 way 1 module	332	20/200
5736 52	Switch - 20 A-SP - 1 way 2 module	390	10/100
5725 63	Switch - 20 A-SP - 1 way with indicator - 1 module	348	20/200
5736 11	Switch - 20 A-SP - 2 way with indicator - 1 module	478	20/200
5725 42	Switch - 20 A-SP - 2 way with indicator - 2 module	512	10/100
5725 43	Switch - 20 A-3 gang - 1 way - 2 module	946	10/100
5725 44	Switch - 20 A-3 gang - 2x2 way + 1x1 way - 2 module	992	10/100
5736 54	Switch 20 A-DP - 1 way with indicator - 2 module	768	10/100
5725 49	Switch - 20 A-DP - 1 way with indicator and water heater marking - 2 module	814	10/100

Bold Cat.Nos are products normally available with Legrand (India) Stockists. Cat.Nos that are not bold - delivery within 4 - 8 weeks from the date of order. Bold packing quantity is our mandatory packing. Orders to be placed by Legrand (India) Stockist in multiples of the same.

Arteor™ square - magnesium mechanisms

Cat.Nos	Description	MRP* ₹ / Unit	Pack
---------	-------------	------------------	------

Switches – 25 A - 230 V AC

5736 17	25A switch with indicator	440	20/200
---------	---------------------------	-----	--------

Switches – 32 A / 40 A - 250 V AC

5736 12	Switch - 32 A-DP - 1 way with indicator - 2 module	1072	10/100
5737 30	Switch - 40 A-DP - 1 way with indicator - fits on 1/2 module box	1228	1/5/20

Push button – 6 A - 250 V AC

5736 13	Bell push - 6 A-SP- 1 way- 1 module	266	20/200
5736 59	Bell push - 6 A-SP - 1 way- 2 module	382	10/100
5736 04	Push button - 6 A-SP - 1 way -1 module	276	20/200
5736 05	Push button - 6 A-SP - 1 way with indicator-1 module	368	20/200
5736 14	Bell push - 6 A-SP - 1 way with indicator - 1 module	366	20/200
5736 60	Bell push - 6 A-SP - 1 way with indicator - 2 module	510	10/100

Electric roller blinds control

5727 20	Double switch for electric shutter - 2 module	668	10/100
---------	---	-----	--------

Dimmers and fan regulators

5736 62	Light dimmer - 60 to 400 watts - 2 module	1104	1/10/100
5736 16	Fan step regulator - 100 watts - 1 module	884	1/5/50
5736 63	Fan step regulator - 100 watts - 2 module	1086	1/10/100
5736 69	Fan step regulator - 120 watts - 2 module (for 48 & 56" fans)	1162	1/10/100
5736 68	Fan step regulator - 2 module for energy saving fan	1156	1/10/100

Indian standard sockets

5736 70	Socket shuttered - 6 A - 2/3 pin - universal India - 2 module	336	20/200
5736 71	Socket shuttered - 6/16 A - 3 pin - Indian - 2 module	442	10/100
5736 67	Socket shuttered - 6/16 A - 3 pin - Indian - 3 module	540	5/50
5736 72	Socket - 13 A - 3 pin - 2P+E BS - 2 module	696	10/100
5737 10	Socket with switch - 16 A - 3 pin - 2P+E - Indian - 3 module	1250	5/50
5726 04	Socket - 15/16 A - 2P - Euro/US - 1 module	448	10/100
5739 79	Socket w - 6 A/13 A/15 A for 127 V, - double multistandard - 4 module	766	5/50
5736 73	Multistandard socket - 6/10/13 A - 2/3 pin for 250 V AC 15 A for 127 V type - 2 pin 2 module	410	10/100
5736 66	25 A socket - 2 module	538	10/100
5726 16	Euro/US 15 A-127 VA/16 A -230 V 2P+E with shutter 2 M	640	10/100

* MRP - Maximum Retail Price Inclusive of all taxes.

Red Cat.Nos - new products

(3) Supplied without Cover plate

■ Price available on request.

Arteor™ square - magnesium mechanisms

Cat.Nos	Description	MRP* ₹ / Unit	Pack
---------	-------------	------------------	------

Energy plugs

5738 87	6 A plug	196	1/10/100
5738 89	16 A plug	258	1/10/100
5738 90	25 A plug	290	1/10/100

USB chargers (IS13252 (Part 1) / IEC 60950-1)

5736 21	USB Charger 1M 1000mA	1458	10/100
5736 22	Double USB Charger 2M 2400mA	2316	1/10/100

RJ 11 telephone sockets (Jack type)

5736 27	Telephone socket - double RJ11 - 1 module	394	20/200
5736 26	Telephone socket - RJ11 with shutter - 1 module	240	20/200

Information outlets - toolless

5736 29	Information socket - category 5e - UTP - 1 module	544	20/200
5736 75	Information socket - category 5e - UTP - 2 module	584	10/100
5736 28	Information socket - category 6 - UTP - 1 module	826	20/200
5736 74	Information socket - category 6 - UTP - 2 module	872	10/100
5728 06	Information socket - 10G - STP - 1 module	■	10/100
5736 30	Information socket - category 5e - FTP - 1 module	■	20/200
5736 76	Information socket - category 6 - FTP - 2 module	■	10/100
5736 34	Information socket - category 6 - STP - 1 module	■	20/200
5736 77	Information socket - category 6 - STP - 2 module	■	10/100

TV sockets

5736 25	TV Co-Axial socket - 1 module	244	20/200
---------	-------------------------------	-----	--------

Electronic chime

5736 43	Bell ding dong 230 V - 2 module	336	10/100
---------	---------------------------------	-----	--------

Buzzer

5736 42	Buzzer- 230 V - 1 module	1224	20/200
---------	--------------------------	------	--------

Bell call indicator & register - 6A - 250V AC

5736 15	Bell call indicator with register - 6 A - 1 way - SP - 1 module	1608	20/200
---------	---	------	--------

Lighting

5735 64	Skirting light with LED - 230 V - 3 module	862	1/5/25
5727 26	Skirting light with detector (LED) - 230 V - 2 module	18100	1/20

Power strip and power units (without plate)

5739 80	Set of 3 multistandard socket + switch pre-wired - 8 module	2236	1/10
5737 42 ⁽³⁾	Power unit (AC & Geyser) 16 A - 4 module	1434	1/5
5726 54	Power unit (AC & Geyser) 32 A (with cable output) 4 module	1630	1/5

Bold Cat.Nos are products normally available with Legrand (India) Stockists. Cat.Nos that are not bold - delivery within 4 - 8 weeks from the date of order. Bold packing quantity is our mandatory packing. Orders to be placed by Legrand (India) Stockist in multiples of the same.

Arteor™ square - magnesium mechanisms

Cat.Nos	Description	MRP* ₹ / Unit	Pack
---------	-------------	------------------	------

Hotel "DND and MMR " functions

5736 61	DND and MMR indicator with bell push 1+1 module	1722	5/50
5736 58	Internal control unit for DND & MMR 1+1 module	1242	10/100



5736 61

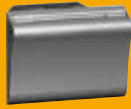

5727 30

Hotel keycard switch

5727 30	Key card switch 230 V with time delay - 2 module	5484	1/20
5727 27	Single pole latching relay	3790	1/20
5727 59	Key fob for above	1550	10/50

Shaver socket

5726 53	Shaver socket 230 V / 120-230 V with earth connector	4690	1
---------	--	------	---



5726 53

Infrared sensors

5740 97	PIR sensor with neutral - 2 module	9402	1/20
5740 94	PIR sensor without neutral - 2 module	8378	1/20

Keycode switch

5727 52 ⁽²⁾	Keycode switch	24992	1/10
------------------------	----------------	-------	------

Time switch

5740 84	Time delay switch - 2 module	5954	1/20
---------	------------------------------	------	------

Audio-video sockets

5727 72	Double RCA socket (audio) - 1 module	■	1/20
5727 73	Triple RCA socket (audio & video) - 1 module	■	1/20
5727 74	Female 3.5 mm Jack - 1 module	■	1/20
5727 76	Female BNC 75 jack - 1 module	■	1/20
5727 83	Female XLR jack - 2 module	■	1/20
5728 70	Kit HD 15 + Jack Amplified transceiver - 3*4 module	■	1
5727 82	Female HD15 (VGA) - 2 module	■	1/20
5725 97	Preterminated sockets Female HD15 - 1 module	■	1
5727 81	HDMI socket - 2 module	■	1/20
5725 96	Preterminated sockets HDMI 1.4 - 1 module	■	1
5727 84	Line dying down 100 V (25-30 W) 2 module	■	1
5727 77	Male XLR jack 2 module	■	1/20
5727 78	Female 3.5 mm Jack - solder - 1 module	■	1/20
5727 75	USB socket - 1 module	■	1/20



5727 73



5727 74



5727 71



5734 55



5728 35



5728 32

Arteor™ square - magnesium mechanisms

Cat.Nos	Description	MRP* ₹ / Unit	Pack
---------	-------------	------------------	------

Audio-video sockets

5727 79	Female HD15 (VGA) - solder - 1 module	■	1/20
5744 51	S-VIDEO socket - 1 module	■	1/40
5727 88	Female HD15 + Jack 3.5 mm - 2 module	■	1/20

Electronic dimmers

5737 01	Rotary dimmer 1000 W - 2 module to be equipped with 5760 01	■	1/10
5740 57	Dimmer 2x400 W all load - 2 module (supplied with support frame)	■	1/10
5727 11	R-I touch dimmer without neutral 600 W - 2 module to be equipped with 5760 01	■	1/10
5727 39	Universal dimmer without neutral 400 W - 2 module	■	1/10
5760 01*	Support frame for dimmer 5727 11/5740 56/5737 01	■	5

Microswitches

5734 55	Switch without contact 2 Way 230 V - 2 module	■	1/10
5740 50	Universal micro-switch with neutral 2 x 1000 W with leds status 2 Way - 2 module	■	1/10
5740 51	Universal micro-switch with neutral 3 x 1000 W with leds status 2 Way - 2 module	■	1/10
5740 52	All-Load micro-switch without neutral 2 x 400 W with leds status 2 Way - 2 module	■	1/10
5740 53	Universal micro-switch with neutral 1000 W with leds status 2 Way - 2 module	■	1/10

Splitters and access point

5728 36	Wiring splitter Ethernet / Tel FTP LCS - 1 module	■	10/100
5728 35	Wiring splitter Ethernet / Tel UTP LCS - 1 module	■	10/100
5728 32	RJ45 rear pluggable Cat5e FTP white LCS - 2 module	■	10/100
5728 30	RJ45 rear pluggable Cat5e UTP white LCS - 2 module	■	10/100
5728 33	RJ45 rear pluggable Cat6 FTP white LCS - 2 module	■	10/100
5728 31	RJ45 rear pluggable Cat6 UTP white LCS - 2 module	■	10/100

* MRP - Maximum Retail Price Inclusive of all taxes.

(2) Supplied with Mirror Black plate

Special plate for support frame available on request

Red Cat.Nos - new products

■ Price available on request.

Bold Cat.Nos are products normally available with Legrand (India) Stockists. Cat.Nos that are not bold - delivery within 4 - 8 weeks from the date of order. Bold packing quantity is our mandatory packing. Orders to be placed by Legrand (India) Stockist in multiples of the same.

Arteor™ square - magnesium mechanisms

Cat.Nos	Description	MRP* ₹ / Unit	Pack
---------	-------------	------------------	------

Splitters and access point

5728 76	Access point for WIFI POE A+Bg + jack - 4 module	■	1/10
5728 77	Access point for WIFI A+Bg - 4 module	■	1/10
5728 78	Access point for WIFI bg - 4 module	■	1/10

Blanking plate

5736 49	1 module blank	44	20/200
5728 44	2 modules blank	68	10/100

Dedicated switches

5738 00	Dedicated switch - 6 A - 1 way - SP - red - 1 module	212	20/200
5738 01	Dedicated switch - 10 A - 1 way - SP - red - 1 module	214	20/200
5738 02	Dedicated switch - 20 A - 1 way - DP - red - 1 module	740	5/40

Tamper proof and dedicated sockets

5738 08	Tamperproof red Indian socket 6 A (2/3 pin) - 2 module	586	20/200
5738 10	Dedicated socket with switch - 16 A - 3 pin - 2P+E - Indian - 3 module	1534	5/50
5738 09	Insert for tamper proof Indian socket - 6 A	78	1/20/200

Round - white mechanisms

Switches - 6 A - 250 V AC

5733 00	Switch - 6 A-SP - 1 way left - 1 module	220	20/200
5733 01	Switch - 6 A-SP - 1 way right - 1 module	220	20/200
5733 12	Switch - 6 A-SP - 1 way - middle - 1 module	220	20/200
5733 05	Switch - 6 A-SP - 2 way - left - 1 module	262	20/200
5733 06	Switch - 6 A-SP - 2 way - right - 1 module	262	20/200
5733 02	Switch - 6 A-SP - 1 way with indicator - left - 1 module	300	20/200
5733 04	Switch - 6 A-SP - 1 way with indicator - right - 1 module	300	20/200
5733 03	Switch - 6 A-SP - 1 way with indicator - middle - 1 module	300	20/200
5733 07	Switch - 6 A-SP - 2 way with indicator - left - 1 module	378	20/200
5733 08	Switch - 6 A-SP - 2 way with indicator - right - 1 module	378	20/200

Switches - 20 A - 250 V AC

5733 20	Switch - 20 A-SP - 1 way - left - 1 module	352	20/200
5733 21	Switch - 20 A-SP - 1 way - right - 1 module	352	20/200
5730 21	Switch - 20 A-SP - 1 way - middle - 1 module	358	20/200
5733 40	Switch - 20 A-SP - 1 way - 2 module	410	10/100

Arteor™ round - white mechanisms

Cat.Nos	Description	MRP* ₹ / Unit	Pack
---------	-------------	------------------	------

Switches - 20 A - 250 V AC

5720 64	Switch - 20 A-SP - 1 way with indicator-left - 1 module	362	20/200
5720 65	Switch - 20 A-SP - 1 way with indicator-right-1 module	362	20/200
5730 24	Switch - 20 A-SP - 2 way - middle - 1 module	362	20/200
5733 22	Switch - 20 A-SP - 2 way with indicator-left-1 module	506	20/200
5733 23	Switch - 20 A-SP - 2 way with indicator-right-1 module	506	20/200
5730 71	Switch - 20 A-SP - 2 way with indicator - 2 module	448	10/100
5730 72	Switch - 20 A-3 gang - 1 way - 2 module	988	10/100
5730 73	Switch - 20 A-3 gang - 2x2 way+1x1 way-2 module	1084	10/100
5733 42	Switch 20 A-DP - 1 way with indicator-2 module	770	10/100
5730 27	Switch - 20 A-SP - 2 way with indicator - middle - 1 module	506	20/200

Switches - 32A

5733 26	Switch - 32 A-DP - 1 way with indicator - 2 module	1114	10/100
---------	--	------	--------

Push button - 6 A - 250 V AC

5733 31	Bell push - 6 A-SP - 1 way - right - 1 module	276	20/200
5733 30	Bell push - 6 A-SP - 1 way - left - 1 module	276	20/200
5733 46	Bell push - 6 A-SP - 1 way - 2 module	394	10/100
5733 09	Push button - 6 A-SP - 1 way - left - 1 module	292	20/200
5733 11	Push button - 6 A-SP - 1 way - right - 1 module	292	20/200
5733 47	Bell push - 6 A-SP - 1 way with indicator - 2 module	534	10/100
5733 10	Push button - 6 A-SP - 1 way - middle - 1 module	292	20/200

Electric roller blinds control

5732 20	Double pole switch 10A - 2 module	698	10/100
---------	-----------------------------------	-----	--------

Dimmers and fan regulators

5730 66	Light dimmer - 60 to 400 Watts - 2 module	1156	1/10/100
5730 03	Fan step regulator - 100 Watts - 2 module	1134	1/10/100
5730 69	Fan step regulator - 120 Watts - 2 module	1230	1/10/100
5730 04	Fan step regulator - 2 module for energy saving fans	1204	1/10/100

Multistandard sockets

5734 89	Multistandard socket 6/10/13 A - 2/3 pin for 250 V AC 15 A for 127 V type - 2 pin 2 module	416	10/100
---------	--	-----	--------

USB chargers (IS13252 (Part 1) / IEC 60950-1)

5734 23	Double USB Charger 2M 2400mA	2224	1/10/100
---------	------------------------------	------	----------

Information outlets - toolless

5723 24	Information socket - category 6-UTP- 2 module	964	10/100
---------	---	-----	--------











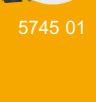

Hotel internal control units

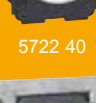
5720 74	Internal control unit for DND & MMR - 1+1 module	1506	5/50
5720 67	DND & MMR indicator with bell push - 2 module	1890	5/40

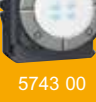
* MRP - Maximum Retail Price Inclusive of all taxes.
Red Cat.Nos - new products
■ Price available on request.

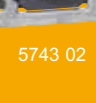

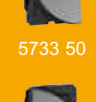
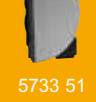







Bold Cat.Nos are products normally available with Legrand (India) Stockists. Cat.Nos that are not bold - delivery within 4 - 8 weeks from the date of order. Bold packing quantity is our mandatory packing. Orders to be placed by Legrand (India) Stockist in multiples of the same.

Arteor™ round - white mechanisms

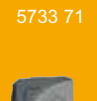
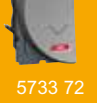
Cat.Nos	Description	MRP* ₹ / Unit	Pack
Audio-video sockets			
 5732 72	Double RCA socket (audio) - 2 module	■	1/20
 5732 73	Triple RCA socket (audio & video) - 2 module	■	1/20
 5722 85	HDMI socket - 2 module	■	1/20
 5732 74	USB socket - 2 module	■	1/20
 5745 01	S-VIDEO socket - 2 module	■	1/20
 5722 89	Female HD15 + Jack 3.5 mm - 2 module	■	1/20
Electronic dimmers			
 5722 40	Rotary dimmer 1000 W - 2 module to be equipped with 5760 01	■	5/60
 5743 07	Dimmer 2x400 W all load - 2 module (supplied with support frame)	■	1/10
 5743 05	R-I touch dimmer without neutral 600 W - 2 module to be equipped with 5760 01	■	1/10
 5743 19	Universal dimmer without neutral 400 W - 2 module	■	1/10
 5760 01*	Support frame 3 module for 5743 05/5743 06/5722 40	■	5
Microswitches			
 5725 51	Switch without contact 2 way 230 V - 2 module	■	1/10
 5743 00	Universal micro-switch with neutral 2x1000 W with leds status 2 way - 2 module	■	1/10
 5743 01	Universal micro-switch with neutral 3x1000 W with leds status 2 way - 2 module	■	1/10
 5743 02	All-load micro-switch without neutral 2x400 W with leds status 2 way - 2 module	■	1/10
 5743 03	Universal micro-switch with neutral 1000 W with leds status 2 way - 2 module	■	1/10
Blanking plate			
5730 87	2 modules blank	70	10/100
Round - magnesium mechanisms			
Switches - 6 A - 250 V AC			
5733 50	Switch - 6 A-SP - 1 way - left - 1 module	256	20/200
5733 51	Switch - 6 A-SP - 1 way - right - 1 module	256	20/200
5733 62	Switch - 6 A-SP - 1 way - middle - 1 module	256	20/200
5733 55	Switch - 6 A-SP - 2 way - left - 1 module	304	20/200
5733 56	Switch - 6 A-SP - 2 way - right - 1 module	304	20/200
5733 52	Switch - 6 A-SP - 1 way with indicator - left - 1 module	338	20/200

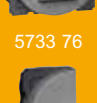
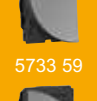
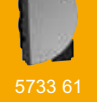
* MRP - Maximum Retail Price Inclusive of all taxes.
Special plate for support frame available on request
Red Cat.Nos - new products
■ Price available on request.

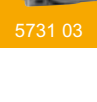
Arteor™ round - magnesium mechanisms

Cat.Nos	Description	MRP* ₹ / Unit	Pack
Switches - 6 A - 250 V AC			
 5733 54	Switch - 6 A-SP - 1 way with indicator - right - 1 module	338	20/200
 5733 53	Switch - 6 A-SP - 1 way with indicator - middle - 1 module	338	20/200
 5733 57	Switch - 6 A-SP - 2 way with indicator - left - 1 module	440	20/200
 5733 58	Switch - 6 A-SP - 2 way with indicator - right - 1 module	440	20/200
Switches - 20 A - 250 V AC			
 5733 70	Switch - 20 A-SP - 1 way - left - 1 module	396	20/200
 5733 71	Switch - 20 A-SP - 1 way - right - 1 module	396	20/200
 5731 21	Switch - 20 A-SP - 1 way - middle - 1 module	396	20/200
 5733 90	Switch - 20 A-SP - 1 way - 2 module	468	10/100
 5725 64	Switch - 20 A-SP - 1 way with indicator - left - 1 module	410	20/200
 5725 65	Switch - 20 A-SP - 1 way with indicator - right - 1 module	410	20/200
 5731 24	Switch - 20 A-SP - 2 way - middle - 1 module	416	20/200
 5733 72	Switch - 20 A-SP - 2 way with indicator - left - 1 module	576	20/200
 5733 73	Switch - 20 A-SP - 2 way with indicator - right - 1 module	576	20/200
 5731 71	Switch - 20 A-SP - 2 way with indicator - 2 module	548	10/100
 5731 72	Switch - 20 A-3 gang - 1 way - 2 module	1132	10/100
 5731 73	Switch - 20 A-3 gang - 2x2 way + 1x1 way - 2 module	1194	10/100
5733 92	Switch 20 A-DP - 1 way with indicator - 2 module	888	10/100
5731 27	Switch - 20 A-SP - 2 way with indicator - middle - 1 module	574	20/200
Switches - 32A			
5733 76	Switch - 32 A-DP - 1 way with indicator - 2 module	1276	10/100
Push button - 6 A - 250 V AC			
5733 81	Bell push - 6 A-SP - 1 way - right - 1 module	322	20/200
5733 80	Bell push - 6 A-SP - 1 way - left - 1 module	322	20/200
5733 96	Bell push - 6 A-SP - 1 way - 2 module	458	10/100
5733 59	Push button - 6 A-SP - 1 way - left - 1 module	338	20/200
5733 61	Push button - 6 A-SP - 1 way - right - 1 module	338	20/200
5733 97	Bell push - 6 A-SP - 1 way with indicator - 2 module	604	10/100
5733 60	Push button - 6 A-SP - 1 way - middle - 1 module	338	20/200
Electronic roller blinds control			
5737 20	Double pole switch 10 A - 2 module	810	10/100
Dimmers and fan regulators			
5733 66	Light dimmer - 60 to 400 watts - 2 module	1340	1/10/100
5731 03	Fan step regulator - 100 watts - 2 module	1304	1/10/100

Bold Cat.Nos are products normally available with Legrand (India) Stockists. Cat.Nos that are not bold - delivery within 4 - 8 weeks from the date of order. Bold packing quantity is our mandatory packing. Orders to be placed by Legrand (India) Stockist in multiples of the same.

Arteor™ round - magnesium mechanisms

Cat.Nos	Description	MRP* ₹ / Unit	Pack
---------	-------------	------------------	------

Dimmers and fan regulators

5731 69	Fan step regulator - 120 watts - 2 module	1410	1/10/100
5731 04	Fan step regulator-2 module for energy saving fans	1386	1/10/100

Multistandard sockets

5736 89#	Multistandard socket 6/10/13 A - 2/3 pin for 250 V AC 15 A for 127 V type - 2 pin 2 module	476	10/100
----------	--	-----	--------

USB chargers (IS13252 (Part 1) / IEC 60950-1)

5736 23	Double USB Charger 2M 2400mA	2550	1/10/100
----------------	------------------------------	------	----------

Information outlets - toolless

5728 24	Information socket - category 6 - UTP-2 module	1104	10/100
---------	--	------	--------

Hotel internal control units

5725 74	Internal control unit for DND & MMR - 1+1 module	1728	5/50
5725 67	DND & MMR Indicator with bell push - 2 module	2066	5/40

Audio-video sockets

5737 72	Double RCA socket (audio) - 2 module	■	1/20
5737 73	Triple RCA socket (audio & video) - 2 module	■	1/20
5727 85	HDMI socket - 2 module	■	1/20
5737 74	USB socket - 2 module	■	1/20
5745 51	S-VIDEO socket - 2 module	■	1/20
5727 89	Female HD15 + jack 3.5 mm - 2 module	■	1/20

Electronic dimmers

5727 40	Rotary dimmer 1000 W - 2 module to be equipped with 5760 01	■	5/60
5743 57	Dimmer 2x400 W all Load - 2 module (supplied with support frame)	■	1/10
5743 55	R-I touch dimmer without neutral 600 W without leds (78405) bargraphe- 2 module to be equipped with 5760 01	■	1/10
5743 39	Universal dimmer without neutral 400 W - 2 module	■	1/10
5760 01#	Support frame 3 module for 5743 55/5743 56/5727 40	■	5

Microswitches

5736 55	Switch without contact 2 way 230 V - 2 module	■	1/10
5743 50	Universal micro-switch with neutral 2x1000 W with leds status 2 way - 2 module	■	1/10
5743 51	Universal micro-switch with neutral 3x1000 W with leds status 2 way - 2 module	■	1/10
5743 52	All-load micro-switch without neutral 2x400 W with leds status 2 way - 2 module	■	1/10
5743 53	Universal micro-switch with neutral 1000 W with leds status 2 way - 2 module	■	1/10

Blanking plate

5731 87	2 modules blank	84	10/100
---------	-----------------	----	--------

* MRP - Maximum Retail Price Inclusive of all taxes.
Special plate for support frame available on request
Red Cat.Nos - new products
■ Price available on request.

Arteor™ square cover plates

Cat.Nos	Description	MRP* ₹ / Unit	Pack
---------	-------------	------------------	------

White cover plates with frame

5757 00	White plate - 1 module	144	10/100
5757 10	White plate - 2 module	152	10/100
5757 20	White plate - 3 module	170	10/100
5757 30	White plate - 4 module	180	5/50
5757 40	White plate - 6 module	326	5/30
5757 50	White plate - 8 module	362	5/30
5757 60	White plate - 2x4 module	456	2/20
5757 70	White plate - 2x6 module	558	2/16
5757 80	White plate - 2x8 module	668	2/16
5757 90	White plate - 3x6 module	740	2/12
5758 00	White plate for shaver socket 3 module	886	2/12
5750 70	White plate for shaver socket 3 module	258	5/50

Pearl aluminium cover plates with frame

5757 01	Pearl aluminium plate - 1 module	260	10/100
5757 11	Pearl aluminium plate - 2 module	274	10/100
5757 21	Pearl aluminium plate - 3 module	296	10/100
5757 31	Pearl aluminium plate - 4 module	334	5/50
5757 41	Pearl aluminium plate - 6 module	570	5/30
5757 51	Pearl aluminium plate - 8 module	628	5/30
5757 61	Pearl aluminium plate - 2x4 module	800	2/20
5757 71	Pearl aluminium plate - 2x6 module	1040	2/16
5757 81	Pearl aluminium plate - 2x8 module	1172	2/16
5757 91	Pearl aluminium plate - 3x6 module	1372	2/12
5758 01	Pearl aluminium plate - 3x8 module	1564	2/12
5750 71	Pearl aluminium plate for shaver socket 3 module	448	5/50

Graphite cover plates with frame





5757 02	Graphite plate - 1 module	260	10/100
5757 12	Graphite plate - 2 module	274	10/100
5757 22	Graphite plate - 3 module	296	10/100
5757 32	Graphite plate - 4 module	334	5/50
5757 42	Graphite plate - 6 module	570	5/30
5757 52	Graphite plate - 8 module	628	5/30
5757 62	Graphite plate - 2x4 module	800	2/20
5757 72	Graphite plate - 2x6 module	1040	2/16
5757 82	Graphite plate - 2x8 module	1172	2/16
5757 92	Graphite plate - 3x6 module	1372	2/12
5758 02	Graphite plate - 3x8 module	1564	2/12
5750 72	Graphite plate for shaver socket 3 module	448	5/50

Tattoo finish cover plates with frame

5762 98	Tattoo plate - 1 module	394	1/5/30
5763 18	Tattoo plate - 2 module	424	1/5/30
5763 38	Tattoo plate - 3 module	458	1/20
5763 58	Tattoo plate - 4 module	484	1/20
5763 88	Tattoo plate - 6 module	880	1/5
5764 08	Tattoo plate - 8 module	972	1/5
5761 68	Tattoo plate - for shaver socket 3 module	564	5/50



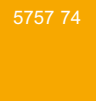



















Bold Cat.Nos are products normally available with Legrand (India) Stockists. Cat.Nos that are not bold - delivery within 4 - 8 weeks from the date of order. Bold packing quantity is our mandatory packing. Orders to be placed by Legrand (India) Stockist in multiples of the same.

Arteor™ square cover plates

Cat.Nos	Description	MRP* ₹ / Unit	Pack
Mirror finish cover plates with frame			
 5757 03	Mirror black plate - 1 module	1420	1/5/30
 5762 96	Mirror red plate - 1 module	1420	1/5/30
 5762 95	Mirror taupe plate - 1 module	1420	1/5/30
 5757 04	Mirror white plate - 1 module	1420	1/5/30
 5757 13	Mirror black plate - 2 module	1518	1/5/30
 5763 16	Mirror red plate - 2 module	1518	1/5/30
 5763 15	Mirror taupe plate - 2 module	1518	1/5/30
 5757 14	Mirror white plate - 2 module	1518	1/5/30
 5757 23	Mirror black plate - 3 module	1626	1/20
 5763 36	Mirror red plate - 3 module	1626	1/20
 5763 35	Mirror taupe plate - 3 module	1626	1/20
5757 24	Mirror white plate - 3 module	1626	1/20
5757 33	Mirror black plate - 4 module	1728	1/20
5763 56	Mirror red plate - 4 module	1728	1/20
5763 55	Mirror taupe plate - 4 module	1728	1/20
5757 34	Mirror white plate - 4 module	1728	1/20
5757 43	Mirror black plate - 6 module	3148	1/5
5763 86	Mirror red plate - 6 module	3148	1/5
5763 85	Mirror taupe plate - 6 module	3148	1/5
5757 44	Mirror white plate - 6 module	3148	1/5
5757 63	Mirror black plate - 2x4 module	4388	1/10
5757 64	Mirror white plate - 2x4 module	4472	1/10
5757 53	Mirror black plate - 8 module	3462	1/5
5764 06	Mirror red plate - 8 module	3462	1/5
5764 05	Mirror taupe plate - 8 module	3462	1/5
5757 54	Mirror white plate - 8 module	3462	1/5
5757 73	Mirror black plate - 2x6 module	5400	1/8
5757 74	Mirror white plate - 2x6 module	5400	1/8
5750 74	Mirror white plate for shaver socket 3 module	2368	1/5/50
5750 73	Mirror black plate for shaver socket 3 module	2368	1/5/50
5761 66	Mirror red plate - for shaver socket 3 module	2368	1/5/50
5761 65	Mirror taupe plate - for shaver socket 3 module	2368	1/5/50

* MRP - Maximum Retail Price Inclusive of all taxes.

Arteor™ square cover plates

Cat.Nos	Description	MRP* ₹ / Unit	Pack
Graphic cover plates with frame			
 5762 91	Graphic casual plate - 1 module	1726	1/5/30
 5762 92	Graphic formal plate - 1 module	1726	1/5/30
 5763 11	Graphic casual plate - 2 module	1856	1/5/30
 5763 12	Graphic formal plate - 2 module	1856	1/5/30
 5763 31	Graphic casual plate - 3 module	1992	1/5/20
 5763 32	Graphic formal plate - 3 module	1992	1/20
 5763 51	Graphic casual plate - 4 module	2126	1/20
 5763 52	Graphic formal plate - 4 module	2126	1/5/20
 5763 81	Graphic casual plate - 6 module	3848	1/5
 5763 82	Graphic formal plate - 6 module	3848	1/5
 5764 01	Graphic casual plate - 8 module	4244	1/5
5764 02	Graphic formal plate - 8 module	4244	1/5
5761 61	Graphic casual for shaver socket 3 module	2896	1/5/50
5761 62	Graphic formal for shaver socket 3 module	2896	1/5/50
Metal finish cover plates with frame			
 5762 90	Gold brass plate - 1 module	2314	1/5/30
 5757 06	Stainless steel plate - 1 module	2314	1/5/30
 5763 10	Gold brass plate - 2 module	2476	1/5/30
 5757 16	Stainless steel plate - 2 module	2476	1/5/30
 5763 30	Gold brass plate - 3 module	2662	1/20
 5757 26	Stainless steel plate - 3 module	2662	1/20
 5763 50	Gold brass plate - 4 module	2826	1/20
 5757 36	Stainless steel plate - 4 module	2826	1/20
 5763 80	Gold brass plate - 6 module	5142	1/5
 5757 46	Stainless steel plate - 6 module	5142	1/5
 5757 66	Stainless steel plate - 2x4 module	7150	1/10
5764 00	Gold brass plate - 8 module	5654	1/5
5757 56	Stainless steel plate - 8 module	5654	1/5
5757 76	Stainless steel plate - 2x6 module	8810	1/8
5750 76	Stainless steel plate - for shaver socket 3 module	3224	1/5/50
5761 60	Gold brass plate - for shaver socket 3 module	3224	1/5/50

Bold Cat.Nos are products normally available with Legrand (India) Stockists. Cat.Nos that are not bold - delivery within 4 - 8 weeks from the date of order. Bold packing quantity is our mandatory packing. Orders to be placed by Legrand (India) Stockist in multiples of the same.

Arteor™ square cover plates

Cat.Nos	Description	MRP* ₹ / Unit	Pack
Wood cover plates with frame			
5762 99	Wood - light oak plate - 1 module	3756	1/5/30
5757 05	Wood - light wenge - 1 module	3756	1/5/30
5763 19	Wood - light oak plate - 2 module	4036	1/5/30
5757 15	Wood - light wenge - 2 module	4036	1/5/30
5763 39	Wood - light oak plate - 3 module	4310	1/20
5757 25	Wood - light wenge - 3 module	4310	1/20
5763 59	Wood - light oak plate - 4 module	4596	1/20
5757 35	Wood - light wenge - 4 module	4596	1/20
5763 89	Wood - light oak plate - 6 module	8346	1/5
5765 75	Wood - light wenge - 6 module	8346	1/5
5764 09	Wood - light oak plate - 8 module	9188	1/5
5765 95	Wood - light wenge - 8 module	9188	1/5
5761 69	Wood - light oak plate - for shaver socket - 3 module	5232	1/5/50
5750 75	Wood - light wenge - for shaver socket - 3 module	5232	1/5/50

Leather cover plates with frame

5762 93	Leather club plate - 1 module	4472	1/5/30
5762 94	Leather galuchat plate - 1 module	6638	1/5/30
5763 13	Leather club plate - 2 module	4802	1/5/30
5763 14	Leather galuchat plate - 2 module	7128	1/5/30
5763 33	Leather club plate - 3 module	5148	1/20
5763 34	Leather galuchat plate - 3 module	7630	1/20
5763 53	Leather club plate - 4 module	5480	1/20
5763 54	Leather galuchat plate - 4 module	8124	1/20
5763 83	Leather club plate - 6 module	9948	1/5
5763 84	Leather galuchat plate - 6 module	14758	1/5
5764 03	Leather club plate - 8 module	10944	1/5
5764 04	Leather galuchat plate - 8 module	16236	1/5
5761 63	Leather club plate - for shaver socket 3 module	2508	1/5/50
5761 64	Leather galuchat plate - for shaver socket 3 module	5162	1/5/50

Woven metal cover plates with frame

5762 97	Woven metal plate - 1 module	5334	1/5/30
5763 17	Woven metal plate - 2 module	5738	1/5/30
5763 37	Woven metal plate - 3 module	6132	1/20
5763 57	Woven metal plate - 4 module	6536	1/20
5763 87	Woven metal plate - 6 module	11874	1/5
5764 07	Woven metal plate - 8 module	13056	1/5
5761 67	Woven metal plate - for shaver socket 3 module	2408	1/5/50

* MRP - Maximum Retail Price Inclusive of all taxes.

Arteor™ round cover plates

Cat.Nos	Description	MRP* ₹ / Unit	Pack
White cover plates with frame			
5759 00	White plate - 2 module	244	10/100
5759 10	White plate - 3 module	258	10/100
5759 20	White plate - 4 module	270	5/50
5759 30	White plate - 6 module	494	5/30
5765 80	White plate - 8 module	542	5/30
5759 40	White plate - 2x4 module	574	2/20
5759 50	White plate - 2x6 module	840	2/16

Pearl aluminium cover plates with frame

5759 01	Pearl aluminium plate - 2 module	362	10/100
5759 11	Pearl aluminium plate - 3 module	382	10/100
5759 21	Pearl aluminium plate - 4 module	408	5/50
5759 31	Pearl aluminium plate - 6 module	736	5/30
5765 81	Pearl aluminium plate - 8 module	812	5/30
5759 41	Pearl aluminium plate - 2x4 module	852	2/20
5759 51	Pearl aluminium plate - 2x6 module	1264	2/16

Graphite cover plates with frame

5759 02	Graphite plate - 2 module	362	10/100
5759 12	Graphite plate - 3 module	382	10/100
5759 22	Graphite plate - 4 module	408	5/50
5759 32	Graphite plate - 6 module	736	5/30
5765 82	Graphite plate - 8 module	812	5/30
5759 42	Graphite plate - 2x4 module	852	2/20
5759 52	Graphite plate - 2x6 module	1264	2/16

Tattoo finish cover plates with frame













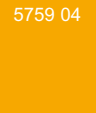

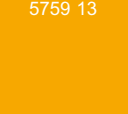

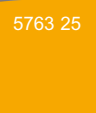

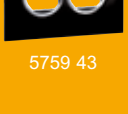

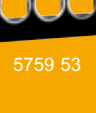

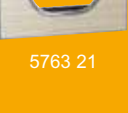

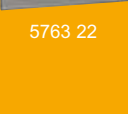
5763 08	Tattoo plate - 2 module	506	1/5/30
5763 28	Tattoo plate - 3 module	542	1/20
5763 48	Tattoo plate - 4 module	576	1/20
5763 68	Tattoo plate - 6 module	1044	1/5
5763 98	Tattoo plate - 8 module	1146	1/5

Mirror finish cover plates with frame

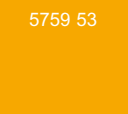
5759 03	Mirror black plate - 2 module	1678	1/5/30
5763 06	Mirror red plate - 2 module	1678	1/5/30
5763 05	Mirror taupe plate - 2 module	1678	1/5/30

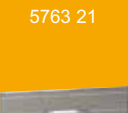
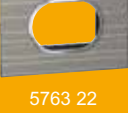

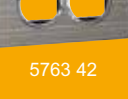







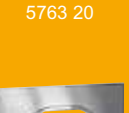

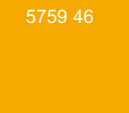
Bold Cat.Nos are products normally available with Legrand (India) Stockists. Cat.Nos that are not bold - delivery within 4 - 8 weeks from the date of order. Bold packing quantity is our mandatory packing. Orders to be placed by Legrand (India) Stockist in multiples of the same.

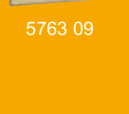
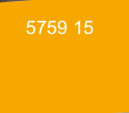
Arteor™ round cover plates

Cat.Nos	Description	MRP* ₹ / Unit	Pack
Mirror finish cover plates with frame			
 5759 04	Mirror white plate - 2 module	1678	1/5/30
 5759 13	Mirror black plate - 3 module	1792	1/20
 5763 26	Mirror red plate - 3 module	1792	1/20
 5763 25	Mirror taupe plate - 3 module	1792	1/20
 5759 14	Mirror white plate - 3 module	1792	1/20
 5759 23	Mirror black plate - 4 module	1910	1/20
 5763 46	Mirror red plate - 4 module	1910	1/20
 5763 45	Mirror taupe plate - 4 module	1910	1/20
 5759 24	Mirror white plate - 4 module	1910	1/20
 5759 33	Mirror black plate - 6 module	3454	1/5
 5763 66	Mirror red plate - 6 module	3454	1/5
 5763 65	Mirror taupe plate - 6 module	3454	1/5
 5759 34	Mirror white plate - 6 module	3454	1/5
 5759 43	Mirror black plate - 2x4 module	4498	1/10
 5759 44	Mirror white plate - 2x4 module	4588	1/10
 5765 83	Mirror black plate - 8 module	3812	1/5
 5763 96	Mirror red plate - 8 module	3812	1/5
 5763 95	Mirror taupe plate - 8 module	3812	1/5
 5765 84	Mirror white plate - 8 module	3812	1/5
 5759 53	Mirror black plate - 2x6 module	5944	1/8
 5759 54	Mirror white plate - 2x6 module	5944	1/8
Graphic cover plates with frame			
 5763 01	Graphic casual plate - 2 module	2046	1/5/30
 5763 02	Graphic formal plate - 2 module	2046	1/5/30
 5763 21	Graphic casual plate - 3 module	2190	1/20
 5763 22	Graphic formal plate - 3 module	2190	1/20
 5763 41	Graphic casual plate - 4 module	2332	1/20
 5763 42	Graphic formal plate - 4 module	2332	1/20
 5763 61	Graphic casual plate - 6 module	4236	1/5
5763 62	Graphic formal plate - 6 module	4236	1/5
5763 91	Graphic casual plate - 8 module	4664	1/5
5763 92	Graphic formal plate - 8 module	4664	1/5

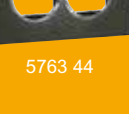
* MRP - Maximum Retail Price Inclusive of all taxes.

Arteor™ round cover plates

Cat.Nos	Description	MRP* ₹ / Unit	Pack
Metal finish cover plates with frame			
 5763 00	Gold brass plate - 2 module	2726	1/5/30
 5759 06	Stainless steel plate - 2 module	2726	1/5/30
 5763 20	Gold brass plate - 3 module	2916	1/20
 5759 16	Stainless steel plate - 3 module	2916	1/20
 5763 40	Gold brass plate - 4 module	3112	1/20
 5759 26	Stainless steel plate - 4 module	3112	1/20
 5763 60	Gold brass plate - 6 module	5652	1/5
 5759 36	Stainless steel plate - 6 module	5652	1/5
 5759 46	Stainless steel plate - 2x4 module	7872	1/10
 5763 90	Gold brass plate - 8 module	6224	1/5
 5765 86	Stainless steel plate - 8 module	6224	1/5
 5759 56	Stainless steel plate - 2x6 module	9690	1/8
Wood cover plates with frame			
 5763 09	Wood - light oak plate - 2 module	4434	1/5/30
 5759 05	Wood - light wenge - 2 module	4434	1/5/30
 5763 29	Wood - light oak plate - 3 module	4742	1/20
 5759 15	Wood - light wenge - 3 module	4742	1/20
 5763 49	Wood - light oak plate - 4 module	5056	1/20
 5759 25	Wood - light wenge - 4 module	5056	1/20
5763 69	Wood - light oak plate - 6 module	9178	1/5
5759 35	Wood - light wenge - 6 module	9178	1/5
5763 99	Wood - light oak plate - 8 module	10096	1/5
5765 85	Wood - light wenge - 8 module	10096	1/5
Leather cover plates with frame			
5763 03	Leather club plate - 2 module	5290	1/5/30
5763 04	Leather galuchat plate - 2 module	7844	1/5/30
5763 23	Leather club plate - 3 module	5656	1/20
5763 24	Leather galuchat plate - 3 module	8386	1/20
5763 43	Leather club plate - 4 module	6026	1/20
5763 44	Leather galuchat plate - 4 module	8938	1/20
5763 63	Leather club plate - 6 module	10938	1/5
5763 64	Leather galuchat plate - 6 module	16236	1/5
5763 93	Leather club plate - 8 module	12038	1/5
5763 94	Leather galuchat plate - 8 module	17854	1/5

Bold Cat.Nos are products normally available with Legrand (India) Stockists. Cat.Nos that are not bold - delivery within 4 - 8 weeks from the date of order. Bold packing quantity is our mandatory packing. Orders to be placed by Legrand (India) Stockist in multiples of the same.

Arteor™ round cover plates

Cat.Nos	Description	MRP* ₹ / Unit	Pack
Woven metal cover plates with frame			
5763 07	Woven metal plate - 2 module	6308	1/5/30
5763 27	Woven metal plate - 3 module	6752	1/20
5763 47	Woven metal plate - 4 module	7194	1/20
5763 67	Woven metal plate - 6 module	13060	1/5
5763 97	Woven metal plate - 8 module	14366	1/5

Accessories

Plastic surface boxes

5734 91	Surface box - 1/2 module	96	10/50
5735 20	Surface box - 3 module	114	5/35
5735 70	Surface box - 4 module	140	5/25
5735 71	Surface box - 6 module	172	1/10
5723 94	Surface box - 8 module	194	1/10
5735 74	Surface box - 2x4 module	236	2/10
5735 72	Surface box - 12/16 module	606	2/10
5735 73	Surface box - 18/24 module	640	2/8

Metal flush boxes

6890 07	Metal flush mounting Box - 1/2 module	90	40
6890 08	Metal flush mounting Box - 3 module	90	40
6890 09	Metal flush mounting Box - 4 module	118	40
6890 10	Metal flush mounting Box - 6 module	186	40
6890 42	Metal flush mounting Box - 8 module	216	40
6890 31	Metal flush mounting Box - 4x2 module	214	20
6890 11	Metal flush mounting Box - 12 /16 module	324	10
6890 12	Metal flush mounting Box - 18 / 24 module	412	10

IP 55 Plexo box and accessories

0696 51	Grey Plexo box for 2 module	254	10/100
0696 72	Grey Plexo box for 2 x 2 module use two nos. of 0695 80	826	5/50
0696 80	Grey Plexo box for 2 x 2 x 2 module use three nos. of 0695 80	1106	5/25
0696 89	White Plexo box for 2 module	308	10/100

* MRP - Maximum Retail Price Inclusive of all taxes.

Arteor™ accessories

Cat.Nos	Description	MRP* ₹ / Unit	Pack
IP 55 Plexo box and accessories			
0695 80	Grey/White adaptor for IP 55 Plexo with smoked polycarbonate flap for 2 modules	950	10/100
6846 38	Grey Plexo box & adaptor with transparent flap for 3 modules, IP 66	3798	1
IP 55 Plexo box with PVC membrane			
6806 11	Grey Plexo box & adaptor with PVC membrane - 1 module	834	10
6806 12	Grey Plexo box & adaptor with PVC membrane - 2 module	856	10
6806 13	Grey Plexo box & adaptor with PVC membrane - 3 module	1138	10
6806 14	Grey Plexo box & adaptor with PVC membrane - 4 module	1706	5
6806 19	Grey Plexo box & adaptor with PVC membrane - 2 row x 4 module	2774	5
6806 33	Grey Plexo flush adaptor with membrane for 3 module Arteor™ box	914	20

ARTEOR™ | FLOW OF ENERGIES

Guarantee

- The Company at its discretion, will replace products if they have any manufacturing defect within 10 years for switches (without LED lamp) and power sockets. For all other **Arteor™** wiring accessories the guarantee will be 2 years.
- The above guarantee is applicable when the devices are used in Legrand metal flush boxes. Other wise the guarantee period will be reduced by 50%.
- The guarantee is only applicable when the products are installed as per the Company's instructions and not tampered in any manner.
- The guarantee states the Company's entire liability. It does not extend to cover consequential loss or damage or installation costs arising from defective products.

Bold Cat.Nos are products normally available with Legrand (India) Stockists. Cat.Nos that are not bold - delivery within 4 - 8 weeks from the date of order. Bold packing quantity is our mandatory packing. Orders to be placed by Legrand (India) Stockist in multiples of the same.



Remote control switch for light and fan

- Can control 4 lights & 1 fan
- 10 different speed options for fan
- Night lamp on product panel with manual operation option for all functions



Skirting light

- Fitted into the walls at skirting level
- Provides a dim lighting
- Creates a path light during night
- Uses LEDs that saves energy



VSP - Voltage Surge protectors

- Protects electrical devices like laptops, computers, printers and other office equipments from voltage surge
- Blends very well with the modular range of wiring devices



Motion sensor

- Infrared detectors that detect human movements
- Programmed to automatically switch the device on and switch off when not in use, thus, saves energy

More Aesthetics

Flat, sleek and smooth, Myrius with it's curved edges gives it a distinct and appealing look to everyone. Moreover, its minimalistic design makes it look absolutely stunning and desirable. But what makes Myrius truly beautiful is a classic black and white shade that offers an aura of comfort and timelessness.



Black Beauty

A mystic black shade with a grainy matte finish truly complements any decor.



Dimmer

- Creates the perfect ambience
- For the first time dims CFLs too
- Dims halogen lamps



Motor Starter

- Complete protection against overload
- Aesthetically appealing
- For ACs/Geysers etc.



Snowy White

Its gleaming white shade and a perfect glossy finish creates a soothing decor.

Myrius™ More is on.

Be it a couple of extra zeroes to a pay cheque or one more holiday to the list. Be it one more pair of shoes to the collection or just requesting for one more song at a party. It's natural for humans to always expect something more.



Fan regulator



TV/SAT/FM socket



Telephone Socket



Light Marking



AV Connector



RJ 45 Data Socket



Projector connector



Key Fob Switch



Do not disturb Switch





Shaver socket



USB Charger



Modular MCB

Myrius™ More is on.

More acceptance, always and everywhere.

Myrius range of wiring accessories is a classic creation to increase the customer's comfort and improve the work environment. This wide range of innovative products offers solutions for residential, commercial and hospitality projects, thus making it a range that caters to everyone's needs.



Myrius™ mechanisms - white

Cat.Nos	Description	MRP* ₹ / Unit	Pack
---------	-------------	------------------	------

Switches - 6 A - 230 V~

6730 00	6 A switch 1 W - 1 module	140	20/200
6730 01	6 A switch 2 W - 1 module	186	20/200
6730 02	6 A switch 1 W - 1 module with indicator	174	20/200
6730 03	6 A switch 1 W - 1 module with "Light" marking	148	20/200
6730 04	6 A switch 1 W - 1 module with "Fan" marking	148	20/200



6730 00



6730 02

Switches - 10 A - 230 V~

6730 05	10 A switch 1 W - 2 module	216	10/100
6730 06	10 A switch 2 W - 2 module	254	10/100
6730 17	10 A intermediate - 2 module	1402	10/100
6730 07	10 A switch 1 W with indicator - 2 module	268	10/100



6730 06

Switches - 16 A - 230 V~

6730 08	16 A switch 1 W - 1 module	244	20/200
6730 09	16 A switch 2 W - 1 module	284	20/200
6730 10	16 A switch 1 W with indicator - 1 module	294	20/200



6730 09

Switches - 20 A - 230 V~

6730 11	20 A 1 W switch - 1 module	326	20/200
6730 12	20 A DP 1 W switch - 2 module	496	10/100
6730 13	20 A DP 1 W switch with indicator - 2 module	526	10/100
6730 14	20 A 2 W switch - 2 module	548	10/100



6730 13

Switches - 25 A - 230 V~

6730 15	25 A SP 1 W switch with indicator - 1 module	364	20/200
---------	--	-----	--------



6730 15

Switches - 32 A - 230 V~

6730 16	32 A DP switch with indicator - 2 module	814	10/100
---------	--	-----	--------



6730 16

* MRP - Maximum Retail Price Inclusive of all taxes.

Myrius™ mechanisms - white

Cat.Nos	Description	MRP* ₹ / Unit	Pack
---------	-------------	------------------	------

Push buttons

6730 18	6 A push button SP - 1 module	206	20/200
6730 19	6 A push button SP with indicator - 1 module	268	20/200
6730 20	6 A bell push - 1 module	204	20/200
6730 21	6 A bell push with indicator - 1 module	268	20/200
6730 22	6 A bell push - 2 module	308	10/100
6730 23	6 A bell push with indicator - 2 module	366	10/100



6730 20



6730 23

Accessories for switches with indicator

6732 44	Lamp for switches / push buttons	46	5/50
---------	----------------------------------	----	------

Socket - 230 V~

6730 41	6/16 A 2 Pin Euro US socket - 1 module	352	20/200
6730 42	16 A 3 Pin switched socket - 3 module	908	5/50
6730 43	Multistandard socket 6/10/13 A - 2/3 pin for 250 V AC 15 A for 127 V type - 2 pin 2 module	302	10/100
6730 44	6 A 5 Pin universal socket - 2 module	260	20/200
6730 83	6/16 A socket - 3 module	430	5/50
6730 45	6/16 A socket - 2 module	358	10/100
6730 46	6/16 A - Euro socket - 2 module	404	10/100
6730 47	25 A socket - 2 module	448	10/100



6730 41



6730 42



6730 44



6730 47

Power unit

6730 74	Power strip - 8 module 6 A (2 nos.) + 16 A socket (1 no.) + 16 A switch with indicator (1 no.)	2110	1/10
6730 75	Power strip - 8 module 5 Pin 6 A (3 nos.) + 16 A switch with indicator (1 no.)	1658	1/10
6730 76	Power strip - 8 module multistd socket (3 nos.) + 16 A switch (1 no.)	1632	1/10



6730 74



6730 75

Bold Cat.Nos are products normally available with Legrand (India) Stockists. Cat.Nos that are not bold - delivery within 4 - 8 weeks from the date of order. Bold packing quantity is our mandatory packing. Orders to be placed by Legrand (India) Stockist in multiples of the same.

Myrius™ mechanisms - white

Cat.Nos	Description	MRP* ₹ / Unit	Pack
---------	-------------	------------------	------

Dimmer & regulator

6730 24	Rotary dimmer 400 W - 1 module	894	1/5/50
6730 25	Rotary dimmer 650 W - 3 module	1880	1/10
6730 26	Compact fluorescent lamp dimmer - 2 module	2490	1/10
6730 27	Fan step regulator 100 W - 1 module	698	1/5/50
6730 29	Fan step regulator 100 W - 2 module	798	1/10/100
6730 28	Fan step regulator 120 W - 2 module	866	1/10/100
6730 77	Fan step regulator - 2 module for energy saving fans	836	1/10/100

Electronic touch dimmer

6731 38	Universal touch dimmer 3 M	5800	1/10
---------	----------------------------	------	------

Emergency light

0785 12	Emergency light unit - 2 module	5374	1/1
---------	---------------------------------	------	-----

Indicators

0785 73	Triangular bulkhead - Blue - 2 module	222	1/1
0785 71	Triangular bulkhead - colourless - 2 module	222	1/1
0785 72	Triangular bulkhead - green - 2 module	248	1/1
0785 70	Triangular bulkhead - red - 2 module	248	1/1

Skirting light

6730 36	Skirting light with white LED - 3 module	678	1/5/25
---------	--	-----	--------

Bell indicator

6730 33	Bell indicator - 240 V~ - 1 module	978	20/200
---------	------------------------------------	-----	--------

Buzzer

6730 34	Buzzer - 230 V~ - 1 module	966	20/200
---------	----------------------------	-----	--------

Sensor

6730 32	Infra red sensor - 300 W - 2 module	5772	1/10
---------	-------------------------------------	------	------

Remote unit

6730 73	Remote control switch - 4 module	7092	1/5/20
---------	----------------------------------	------	--------

Hospitality functions

Key FOB switch

6730 37	15 A key card switch monobloc with plate - 2 M	3230	1/10
6732 37	15 A key card switch monobloc with new plate - 2 M White	3554	1/10
6730 38	Only key fob for switch Cat.No 6730 37 & 6732 37	162	1/10/100

* MRP - Maximum Retail Price Inclusive of all taxes.
Red Cat.Nos - new products

Myrius™ mechanisms - white

Cat.Nos	Description	MRP* ₹ / Unit	Pack
---------	-------------	------------------	------

"Do not disturb" and MMR control unit

6730 39	External unit - 1+1 module	1376	10/100
6730 40	Internal unit - 1+1 module	920	10/100

Shaver socket

6730 49	Shaver Socket 230 V / 120 - 230 V monobloc with plate - 4 M	4066	1/5/20
6730 79	Shaver Socket 230 V / 120 - 230 V monobloc with new plate - 4 M White	4262	1/5

Sockets and connectors

TV socket

6730 50	TV socket - 1 module	182	20/200
6730 51	TV / Sat / FM 6 shielded socket 2 module	1606	10/100

Data & voice

6730 52	RJ-11 telephone socket with transparent shutter 1 module	178	20/200
6730 53	RJ-11 double telephone socket with shutter 1 module	276	20/200
6730 54	UTP cat 5e information outlets toolless system 1 module	410	20/200
6730 55	UTP cat 6 - 1 module	608	20/200
6730 56	UTP cat 6 - 2 module	620	10/100

USB chargers (IS13252 (Part 1) / IEC 60950-1)

6730 80	USB Charger 1M 1000mA	988	10/100
6731 78	Double USB Charger 2M 2400mA	1560	1/10/100

Audio & video connector

6730 57	3 x female RCA 1 module 1 module	2410	1/10
6730 58	3 pole XLR sockets 2 module	2326	10/100
6730 59	Female HD 15 - 2 module	2862	1/10

Sound (Volume controller)

6730 63	Suitable for 8 Ohms, 3 Watts (RNS) speaker - 2 module	1148	1/10/100
---------	---	------	----------

Protectors and accessories

Motor starter

6730 30	16 A motor starter 2 module	576	1/10/100
6730 31	25 A motor starter 2 module	588	1/10/100

Modular MCB (IS : 60898-1:2002)

6730 64	16A MCB SP 1M C curve	348	1/10/100
6730 65	20A MCB SP 1M C curve	348	1/10/100

RCBO

6730 78	Single pole + Neutral - 30 mA, 16 A - 230 VA 2 module	7668	1/1
---------	---	------	-----

Bold Cat.Nos are products normally available with Legrand (India) Stockists. Cat.Nos that are not bold - delivery within 4 - 8 weeks from the date of order. Bold packing quantity is our mandatory packing. Orders to be placed by Legrand (India) Stockist in multiples of the same.

Myrius™ mechanisms - white

Cat.Nos	Description	MRP* ₹ / Unit	Pack
---------	-------------	---------------------	------

VSP

6730 70	Surge filter (VSP) - 230 V~ 1 module	2348	20/200
---------	---	------	--------

Accessories

6730 60	Cable outlet - 8 mm 1 module	222	20/200
6730 61	Blanking plate - 1 module	40	20/200
6730 62	Blanking plate - 2 module	46	10/100
0802 90	Panel mounting support 1 module	192	10/200
0802 91	Panel mounting support 2 module	196	10/200
0802 99	Din rail mounting support 2 module	240	10/100

Myrius antibacterial switches & accessories - white



6730 84	6 A switch 1 W - 1 module	194	20/200
6730 85	6 A switch 2 W - 1 module	222	20/200
6730 86	6 A bell push - 1 module	246	20/200
6730 89	16 A switch 1 way - 1 module	294	20/200
6730 90	16 A switch 2 way - 1 module	342	20/200
6730 92	Fan regulator 120 W - 2 module	1060	1/10/100
6730 93	Multistandard socket - 2 module	366	10/100
6730 94	6 A 5 pin universal socket 2 module	316	20/200
6730 95	6/16 A socket - 3 module	514	5/50
0787 00	Equipotential socket 1 module antibacterial	1428	1/10
6730 98	T.V. socket - 1 module	216	20/200
6730 99	RJ -11 telephone socket - 1 module	214	20/200
6730 81	RJ-45 Cat 6 UTP - 1 module	746	20/200
6730 82	Blanking plate - 1 module	40	20/200
6732 45	1 module plate + frame 1 module	146	20/200
6732 46	2 module plate + frame 2 module	160	20/200
6732 47	3 module plate + frame 3 module	174	10/100
6732 48	4 module plate + frame 4 module	186	10/100
6732 49	8 module plate + frame (horizontal) 8 module	358	5/50
6732 50	8 module plate + frame (4x2) 8 module	454	5/25
6732 52	16 module plate + frame 16 module	630	1/10

* MRP - Maximum Retail Price Inclusive of all taxes.

Myrius™

Myrius Anti-bacterial



More for your wellness



Myrius anti-bacterial products offer anti-bacterial protection. The composition of the product contain Ag+ ions that eliminates the proliferation of bacteria on contact with the surface of the product. It has a smooth and straight design that facilitates in reducing the dust accumulation. It is self disinfecting throughout its lifespan.

- > Extremely useful in agri-food premises, healthcare environments & premises with high risk in terms of people's fragility.
- > Special protection for the health and hygiene market in the form of an equipotential socket for earthing devices, application to connection of hospital beds and trolleys to medical apparatus to avoid all risk of potential difference during the medical care.

Bold Cat.Nos are products normally available with Legrand (India) Stockists. Cat.Nos that are not bold - delivery within 4 - 8 weeks from the date of order. Bold packing quantity is our mandatory packing. Orders to be placed by Legrand (India) Stockist in multiples of the same.

Myrius™ mechanisms - black

Cat.Nos	Description	MRP* ₹ / Unit	Pack
---------	-------------	------------------	------

Switches – 6 A - 230 V~

6731 00	6 A switch 1 W 1 module	166	20/200
6731 01	6 A switch 2 W 1 module	206	20/200
6731 02	6 A switch 1 W with indicator - 1 module	230	20/200
6731 03	6 A switch 1 W with "Light" marking 1 module	176	20/200
6731 04	6 A switch 1 W with "Fan" marking 1 module	176	20/200

Switches – 10 A - 230 V~

6731 05	10 A switch 1 W 2 module	260	10/100
6731 06	10 A switch 2 W 2 module	284	10/100
6731 17	10 A intermediate switch 2 module	1618	10/100
6731 07	10 A switch 1 W with indicator - 2 module	298	10/100

Switches – 16 A - 230 V~

6731 08	16 A switch 1 way 1 module	274	20/200
6731 09	16 A switch 2 way 1 module	332	20/200
6731 10	16 A switch 1 way with indicator - 1 module	342	20/200

Switches – 20 A - 230 V~

6731 11	20 A 1 W switch 1 module	368	20/200
6731 12	20 A DP 1 W switch 2 module	572	10/100
6731 13	20 A DP 1 W switch with indicator - 2 module	610	10/100
6731 14	20 A 2 W switch 2 module	630	10/100

Switches – 25 A - 230 V~

6731 15	25 A SP 1 W switch with indicator - 1 module	420	20/200
---------	--	-----	--------

Switches – 32 A - 230 V~

6731 16	32 A DP switch with indicator - 2 module	936	10/100
---------	--	-----	--------

* MRP - Maximum Retail Price Inclusive of all taxes.
Red Cat.Nos - new products

Myrius™ mechanisms - black

Cat.Nos	Description	MRP* ₹ / Unit	Pack
---------	-------------	------------------	------

Push buttons

6731 18	6 A push button SP 1 module	242	20/200
6731 19	6 A push button SP with indicator - 1 module	302	20/200
6731 20	6 A bell push - 1 module	230	20/200
6731 21	6 A bell push with indicator - 1 module	302	20/200
6731 22	6 A bell push 2 module	352	10/100
6731 23	6 A bell push with indicator - 2 module	420	10/100

Accessories for switches with indicator

6732 44	Lamp for switches / push buttons	46	5/50
---------	-------------------------------------	----	------

Socket - black

6731 41	6/16 A 2 pin Euro US socket - 1 module	406	20/200
6731 42	16 A 3 pin switched socket - 3 module	1038	5/50
6731 43	Multistandard socket 6/10/13 A - 2/3 pin for 250 V AC 15 A for 127 V type - 2 pin 2 module	358	10/100
6731 44	6 A 5 Pin with universal socket 2 module	290	20/200
6731 83	6/16 A socket 3 module	488	5/50
6731 45	6/16 A socket 2 module	414	10/100
6731 46	6/16 A - Euro socket 2 module	466	10/100
6731 47	25 A socket - 2 module	510	10/100

Socket - red

6730 48	16 A switched socket 3 module	924	5/50
---------	----------------------------------	-----	------

Dimmers & regulators

6731 24	Rotary dimmer 400 W 1 module	1024	1/5/50
6731 25	Rotary dimmer 650 W 3 module	2164	1/10
6731 26	Compact Fluo - 2 module lamp dimmer (Universal load)	2860	1/10
6731 27	Fan step regulator 100 W 1 module	800	1/5/50
6731 29	Fan step regulator 100 W 2 module	908	1/10/100
6731 28	Fan step regulator 120 W 2 module	996	1/10/100
6731 77	Fan step regulator - 2 module for energy saving fans	966	1/10/100

Bold Cat.Nos are products normally available with Legrand (India) Stockists.
Cat.Nos that are not bold - delivery within 4 - 8 weeks from the date of order.
Bold packing quantity is our mandatory packing. Orders to be placed by
Legrand (India) Stockist in multiples of the same.

Myrius™ More is on.

Be it a couple of extra zeroes to a pay cheque or one more holiday to the list. Be it one more pair of shoes to the collection or just requesting for one more song at a party. It's natural for humans to always expect something more.



Black Beauty

A mystic black shade with a grainy matte finish truly complements any decor.



Snowy White

Its gleaming white shade and a perfect glossy finish creates a soothing decor.

NEW



Introducing a new range of plates with unique features & flawless designs, Myrius perfectly defines aestheticism. This range includes two shades; grainy matte black and a glossy white that suits any decor. Also, the designs are crafted with sheer perfection that create an ambience in itself.

Myrius™ mechanisms - black

Cat.Nos	Description	MRP* ₹ / Unit	Pack
---------	-------------	------------------	------

Skirting light

6731 36	Skirting light with white LED - 3 module	778	1/5/25
---------	--	-----	--------

Bell indicator

6731 33	Bell Indicator- 240 V~ 1 module	1142	20/200
---------	---------------------------------	------	--------

Buzzer

6731 34	Buzzer - 230 V~ sound level 72dB at 1 meter distance 1 module	1106	20/200
---------	---	------	--------

Sensor

6731 32	Infra red sensor - 300 W 2 module	6968	1/10
---------	-----------------------------------	------	------

Remote unit

6731 73	Remote control switch 4 module	8234	1/5/20
---------	--------------------------------	------	--------

Hospitality functions

Key FOB switch

6731 37	15 A key card switch with timedelay 30 sec. monobloc with plate - 2 M	3712	1/10
6732 67	15 A key card switch monobloc with new plate - 2 M Black	4084	1/10
6730 38	Only key fob for switch Cat.No 6731 37 & 6732 67	162	1/10/100

"Do not disturb" and MMR control unit

6731 39	External unit - 1+1 module	1578	10/100
6731 40	Internal unit - 1+1 module	1054	10/100

Shaver socket

6731 49	Shaver socket 220/240 V - 50/60 Hz monobloc with plate - 4 M	4452	1/5/20
6731 79	Shaver socket 230 V / 120 - 230 V monobloc with new plate - 4 M Black	4690	1/5

TV socket

6731 50	TV socket - 1 module	214	20/200
6731 51	TV / Sat / FM shielded sockets 0 - 2400 MHz - 2 module	1800	10/100

Data & voice

6731 52	RJ-11 telephone socket with transparent shutter 1 module	206	20/200
6731 53	RJ-11 double telephone socket with shutter 1 module	316	20/200

Myrius™ mechanisms - black

Cat.Nos	Description	MRP* ₹ / Unit	Pack
---------	-------------	------------------	------

Data & voice

6731 54	UTP cat 5e RJ 45 information outlets 1 module	450	20/200
6731 55	UTP cat 6 - 1 module	686	20/200
6731 56	UTP cat 6 - 2 module	696	10/100

NEW! USB chargers (IS13252 (Part 1) / IEC 60950-1)

6731 80	USB Charger 1M 1000mA	1138	10/100
6732 78	Double USB Charger 2M 2400mA	1794	1/10/100

Connectors and controllers

Audio & video connector

6731 57	3 x female RCA -1 module	2776	1/10
6731 58	3 pole XLR sockets 2 module	2620	10/100
6731 59	Female HD 15 - 2 module	3290	1/10

Sound

6731 63	Suitable for 8 Ohms, 8 Ohms, 3 Watts (RNS) speaker - 2 module	1330	1/10/100
---------	---	------	----------

Protectors and accessories

Motor starter

6731 30	16 A motor starter- 2 module	664	1/10/100
6731 31	25 A motor starter- 2 module	678	1/10/100

NEW! Modular MCB (IS : 60898-1:2002)

6731 64	16A MCB SP 1M C curve	400	1/10/100
6731 65	20A MCB SP 1M C curve	400	1/10/100

VSP

6731 70	Surge filter (VSP) - 230 V~ - 1 module	2712	20/200
---------	--	------	--------

Accessories

6731 60	Cable outlet - 8mm 1 module	260	20/200
6731 61	Blanking plate-1 module	42	20/200

Plastic plates

White plates with frame

6732 01	1 Module plate + Frame	124	20/200
6732 02	2 Module plate + Frame	132	20/200
6732 03	3 Module plate + Frame	142	10/100
6732 04	4 Module plate + Frame	152	10/100
6732 06	6 Module plate + Frame	276	5/50
6732 08	8 Module plate + Frame (horizontal)	298	5/50
6732 09	8 Module plate + Frame (4x2)	376	5/25
6732 12	12 Module plate + Frame	450	1/10
6732 16	16 Module plate + Frame	528	1/10
6732 18	18 Module plate + Frame	602	1/10

* MRP - Maximum Retail Price Inclusive of all taxes.
Red Cat.Nos - new products

Bold Cat.Nos are products normally available with Legrand (India) Stockists. Cat.Nos that are not bold - delivery within 4 - 8 weeks from the date of order. Bold packing quantity is our mandatory packing. Orders to be placed by Legrand (India) Stockist in multiples of the same.

Myrius™ plastic plates

Cat.Nos	Description	MRP* ₹ / Unit	Pack
---------	-------------	------------------	------

NEW!

New white plates with frame*

6732 11	1 Module plate + Frame	142	20/200
6732 42	2 Module plate + Frame	150	20/200
6732 13	3 Module plate + Frame	164	10/100
6732 14	4 Module plate + Frame	174	10/100
6732 66	6 Module plate + Frame	322	5/50
6732 68	8 Module plate + Frame (Horizontal)	344	5/50
6732 69	8 Module plate + Frame (4x2)	428	5/25
6732 62	12 Module plate + Frame	518	1/10
6732 56	16 Module plate + Frame	608	1/10
6732 58	18 Module plate + Frame	694	1/10

Black plates with frame

6732 21	1 Module plate + Frame	210	20/200
6732 22	2 Module plate + Frame	230	20/200
6732 23	3 Module plate + Frame	244	10/100
6732 24	4 Module plate + Frame	268	10/100
6732 26	6 Module plate + Frame	468	5/50
6732 28	8 Module plate + Frame (Horizontal)	516	5/50
6732 29	8 Module plate + Frame (4 x 2)	640	5/25
6732 32	12 Module plate + Frame	768	1/10
6732 36	16 Module plate + Frame	900	1/10
6732 38	18 Module plate + Frame	1018	1/10

NEW!

New black plates with frame*

6732 31	1 Module plate + Frame	242	20/200
6732 82	2 Module plate + Frame	262	20/200
6732 33	3 Module plate + Frame	282	10/100
6732 34	4 Module plate + Frame	308	10/100
6732 86	6 Module plate + Frame	540	5/50
6732 88	8 Module plate + Frame (Horizontal)	590	5/50
6732 89	8 Module plate + Frame (4 x 2)	738	5/25
6732 92	12 Module plate + Frame	884	1/10
6732 96	16 Module plate + Frame	1034	1/10
6732 98	18 Module plate + Frame	1170	1/10

Mounting boxes

Flush mounting boxes

6890 07	Flush box - 1/2 module	90	40
6890 08	Flush box - 3 module	90	40
6890 09	Flush box - 4 module	118	40
6890 10	Flush box - 6 module	186	40
6890 42	Flush box - 8 module (specific)	216	40
6890 31	Flush box - 8 module (2 row x 4)	214	20
6890 11	Flush box - 12/16 (2 row x 6) module (metal box)	324	10
6890 12	Flush box - 18 module (metal box)	412	10

* MRP - Maximum Retail Price Inclusive of all taxes.

Red Cat.Nos - new products

The new plate range will be introduced shortly.

Myrius™ mounting boxes

Cat.Nos	Description	MRP* ₹ / Unit	Pack
---------	-------------	------------------	------

Surface mounting boxes

6733 02	Surface box - 1/2 module	86	10/50
6733 03	Surface box - 3 module	104	5/35
6733 04	Surface box - 4 module	120	5/25
6733 06	Surface box - 6 module	152	1/10
6733 08	Surface box - 8 module	226	1/5
6733 05	Surface box - 8 (2 row x 4) module	218	1/5
6890 21	Metal surface box - 12/16 (2 row x 6) module	542	1/6
6890 22	Metal surface box - 18 module	570	1/4

Myrius™

More is on.

Guarantee

- The Company, at its discretion, will replace products if they have any manufacturing defect within 10 years for switches (without neon lamp) and power sockets. For all other **Myrius™** wiring accessories the guarantee will be 2 years.
- The above guarantee is applicable when the devices are used in Legrand metal flush boxes. Otherwise the guarantee period will be reduced by 50%.
- The guarantee is only applicable when the products are installed as per the Company's instructions and not tampered in any manner.
- The guarantee states the Company's entire liability. It does not extend to cover consequential loss or damage or installation costs arising from defective products.

Bold Cat.Nos are products normally available with Legrand (India) Stockists. Cat.Nos that are not bold - delivery within 4 - 8 weeks from the date of order. Bold packing quantity is our mandatory packing. Orders to be placed by Legrand (India) Stockist in multiples of the same.

Mylinc™ **NEW**

A little touch of genius

Mylinc™ is a complete range of modular wiring accessories. Switches and sockets designed and made in India, keeping everyone's requirements in mind. Whether it's safety, reliability, convenience or beauty; Mylinc™ is the smart option in modular switch design.



USB Charger



360° Fan regulator



Remote control unit for Light and Fan



Modular MCB



Champagne



Silver Alu



Dark Bronze



Matt Grey



Pearl White

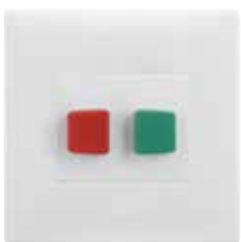

Motor Starter



Skirting Light 2 M



Switch 25 A with indicator



Mylic™ mechanisms

Cat.Nos	Description	MRP* ₹ / Unit	Pack
---------	-------------	------------------	------

Switches and accessories

Switches 6 A - 250 V AC

6755 01	6 A one-way SP switch - 1 module	104	20/200
6755 02	6 A two-way SP switch - 1 module	154	20/200
6755 03	6 A one-way SP switch with indicator - 1 module	182	20/200

Switches 16 A - 250 V AC

6755 11	16 A one-way SP switch - 1 module	174	20/200
6755 12	16 A two-way SP switch - 1 module	220	20/200
6755 13	16 A one-way SP switch with indicator - 1 module	232	20/200

Switch 25 A - 250 V AC

6759 68*	Switch 25 A with indicator - 1 module	274	10/100
----------	--	-----	--------

Switches 32 A - 250 V AC

6755 26	32 A one-way double pole switch with indicator - 2 module	526	10/100
---------	--	-----	--------

Push buttons 6 A - 250 V AC

6755 04	6 A one-way SP bell push - 1 module	160	20/200
6755 06	6 A one-way SP bell push with indicator - 2 module	328	10/100

Bell call indicator & register - 6 A - 250 V AC

6755 07	Bell call Indicator with register - 6 A - one-way - SP - 1 module	876	20/200
---------	--	-----	--------

Lighting modules

6755 95	Indicator light red - 1 module	194	20/200
6755 96	Indicator light orange - 1 module	194	20/200
6755 97	Skirting light with white LED - 3 module	652	1/5/25
6759 76*	Skirting light with white LED - 2 module	442	5/50

Dimmers and fan regulators

6755 35	Rotative dimmer 60 - 250 W for light - 2 module	534	1/10/100
6755 33	Mylic dimmer 400 W for light - 1 module	678	1/5/50
6759 64*	Fan regulator 100 W with 360° rotation - 2 module	598	10/100
6755 30	Fan regulator 100 W, Humfree, 0-4 steps - 2 module	646	1/10/100
6755 31	Fan regulator 100 W, Humfree, 0-4 steps - 1 module	486	1/5/50

* MRP - Maximum Retail Price Inclusive of all taxes.

❖ To be shortly introduced

Red Cat.Nos - new products

Mylic™ mechanisms

Cat.Nos	Description	MRP* ₹ / Unit	Pack
---------	-------------	------------------	------

Buzzer

6755 40	Mylic buzzer	588	20/200
---------	--------------	-----	--------

Remote unit

6759 75*	Remote control unit with remote for 4 switch & fan load 4 m	2960	1/5/20
----------	---	------	--------

DND & MMR

Indicator lamp

6755 56	DND & MMR external unit with bellpush 3 m	310	10/50
6759 69*	DND & MMR external unit with bellpush 1+1 - 2 m	310	10/100
6755 57	Mylic internal control unit for DND & MMR	258	10/100

Hotel key fob switch

6755 60	Hotel key fob switch - monobloc	2842	1/10
6730 38	Only key fob for 6755 60	162	1/10

Energy sockets / power unit

Energy sockets

6755 50	6 A - 2/3 pin combine - 2 module	180	10/100
6755 55	6/16 A - 3 pin combine - 2 module	288	10/100
6755 51	6 A - 3 pin - 2 module	190	10/100
6755 52	Universal socket 6 A - 2/3 pin combine - 2 module	222	10/100
6755 53	Euro US socket 6/16 A - 2 pin, 1 module	278	20/200
6755 54	6/10/13 A - multistandard socket - 2 Module	290	10/100

Power unit

6755 58	Power unit for 2 ton A.C and 3.5 KW geyser - 4 module	1076	5/25
---------	--	------	------

Motor starter

6759 65*	Motor starter 16 A 2 m	500	1/10/100
----------	------------------------	-----	----------

Modular MCB (IS : 60898-1:2002)

6759 74*	Modular SP MCB 16 A 1 m	326	1/10/100
----------	-------------------------	-----	----------

Low voltage sockets / TV socket and RJ11 telephone socket / accessories

Sockets

6755 46	TV socket 1 module	160	20/200
6755 41	RJ 11 telephone socket 1 module	152	20/200
6755 44	Double RJ 11 telephone socket 1 module	254	20/200
6755 45	RJ 45 Cat 6 computer socket 1 module	554	20/200
6755 47	RJ 45 Cat 5e computer socket 1 module	398	20/200
6759 66*	RJ45 socket cat 5e with shutter - 1 module	398	20/200
6759 67*	RJ45 socket cat 6 with shutter - 1 module	554	20/200

Bold Cat.Nos are products normally available with Legrand (India) Stockists. Cat.Nos that are not bold - delivery within 4 - 8 weeks from the date of order. Bold packing quantity is our mandatory packing. Orders to be placed by Legrand (India) Stockist in multiples of the same.

Mylic™ mechanisms

Cat.Nos	Description	MRP* ₹ / Unit	Pack
---------	-------------	------------------	------

USB chargers (IS13252(Part 1) / IEC 60950-1)

6759 71*	USB charger - 1 module	710	10/100
6759 72*	Double USB charger - 2 module	1125	10/100

Accessories

6755 91	Cable outlet - 1 module	144	20/200
6755 90	Blanking plate 0.8 mm - 1 module	36	20/200
6755 92	Spare 12 screws with nuts	54	20/200

Mylic™ plates

Modular white plates with frame

6755 61	1 module plate - white	96	20/200
6755 62	2 modules plate - white	96	20/200
6755 63	3 modules plate - white	130	10/100
6755 64	4 modules plate - white	140	10/100
6755 66	6 modules plate - white	178	5/50
6755 67	8 modules horizontal - white	232	5/50
6755 68	4x2 modules plate - white	234	5/25
6755 69	9 modules plate- white	272	5/50
6755 72	12 modules plate - white	332	10
6755 73	16 modules plate - white	388	10
6755 78	18 modules plate - white	522	10

Mylic™ mechanism matt grey Switches and accessories

Switches 6 A - 250 V AC

6763 01	6 A one-way SP switch - 1 module	114	20/200
6763 02	6 A two-way SP switch - 1 module	170	20/200
6763 03	6 A one-way SP switch with indicator - 1 module	200	20/200

Switches 16 A - 250 V AC

6763 11	16 A one-way SP switch 1 module	192	20/200
6763 12	16 A two-way SP switch 1 module	242	20/200
6763 13	16 A one-way SP switch with indicator 1 module	256	20/200

Switch 25 A - 250V AC

6763 41*	Switch 25 A with indicator - 1 module	302	10/100
----------	---	-----	--------

Switches 32 A - 250V AC

6763 26	32 A one-way double pole switch with indicator - 2 module	578	20/200
---------	--	-----	--------

Push buttons 6 A - 250 V AC

6763 04	6 A one-way SP bell push 1 module	176	20/200
6763 06	6 A one-way SP bell push with indicator 2 module	360	10/100

* MRP - Maximum Retail Price Inclusive of all taxes.

❖ To be shortly introduced

Red Cat.Nos - new products

NEW!

Mylic™ mechanism matt grey

Cat.Nos	Description	MRP* ₹ / Unit	Pack
---------	-------------	------------------	------

Bell call indicator & register - 6 A - 250 V AC

6763 07	Bell call indicator with register - 6 A - one way 1 module	964	20/200
---------	---	-----	--------

Lighting modules

6763 14	Indicator light red 1 module	214	20/200
6763 15	Indicator light orange 1 module	214	20/200
6763 16	Skirting light with white LED - 3 module	718	1/5/25
6763 10*	Skirting light with white LED - 2 module	486	5/50

Dimmers and fan regulators

6763 17	Rotative dimmer 60 - 250 W for light 2 module	588	1/10/100
6763 18	Rotative dimmer 60 - 400 W 1 module	746	1/5/50
6763 37*	Fan regulator 100 W, with 360° rotation 2 module	658	10/100
6763 19	Fan regulator 4 step 2 module	710	1/10/100
6763 20	Fan regulator 4 step 2 module	534	1/5/50

Buzzer

6763 21	Mylic buzzer	646	20/200
---------	--------------	-----	--------

Remote unit

6763 47*	Remote control unit with remote for 4 switch & fan load 4 m	3256	1/5/20
----------	---	------	--------

DND & MMR

Indicator lamp

6763 42*	DND & MMR external unit with bellpush 1+1	342	10/100
6763 23	Mylic internal control unit for DND & MMR	284	10/100
6763 24	Hotel key fob switch monobloc	3126	1/10

Hotel key fob switch

6730 38	Only key fob for 6755 60	162	1/10
---------	--------------------------	-----	------

Energy sockets / power unit

Energy sockets

6763 25	6 A - 2/3 pin combined	198	10/100
6763 00	6/16A - 3 pin Combined 2 module	316	10/100
6763 27	6 A - 3 pin - 2 module	210	10/100
6763 28	Universal socket 6A-2/3 pin combined 2 module	244	10/100

Bold Cat.Nos are products normally available with Legrand (India) Stockists. Cat.Nos that are not bold - delivery within 4 - 8 weeks from the date of order. Bold packing quantity is our mandatory packing. Orders to be placed by Legrand (India) Stockist in multiples of the same.

NEW!

Mylinc™ mechanism matt grey

Cat.Nos	Description	MRP* ₹ / Unit	Pack
---------	-------------	------------------	------

Energy sockets / power unit

Energy sockets

6763 29	Euro US socket 2 module	306	20/200
6763 30	6/10/13 A - Multistandard socket 2 module	320	10/100

Power unit

6763 31	Power unit for 2 ton A.C and 3.5 KW geyser - 4 module	1184	5/25
---------	--	------	------

Motor starter

6763 38*	Motor starter 16 A 2 m	550	1/10/100
----------	------------------------	-----	----------

Modular MCB (IS : 60898-1:2002)

6763 46*	Modular SP MCB 16 A 1 m	358	1/10/100
----------	----------------------------	-----	----------

Low voltage sockets / TV socket and RJ11 telephone socket / accessories

Sockets

6763 32	TV socket - 1 module	176	20/200
6763 33	RJ 11 telephone 1 module	168	20/200
6763 34	Double RJ 11 telephone socket 1 module	280	20/200
6763 39*	RJ 45 socket cat 5e with shutter 1 module	438	20/200
6763 40*	RJ 45 socket cat 6 with shutter 1 module	610	20/200

USB chargers (IS13252(Part 1) / IEC 60950-1)

6763 43	USB charger 1 module	782	10/100
6763 44	Double USB charger 1 module	1238	1/10/100

Accessories

6763 48	Cable outlet 1 module	158	20/200
6763 49	Blanking plate 0.8 mm 1 module	40	20/200

Mylinc™ plates

Modular Matt Grey plates with frame

6763 50*	Matt grey plate 1 m	124	20/200
6763 51	Matt grey plate 2 m	124	20/200
6763 52	Matt grey plate 3 m	170	10/100
6763 53	Matt grey plate 4 m	182	10/100
6763 54*	Matt grey plate 6 m	232	5/50
6763 55*	Matt grey plate 8 m horizontal	302	5/50
6763 56*	Matt grey plate 4x2 m	304	5/25
6763 57	Matt grey 9 m	354	5/50
6763 58*	Matt grey plate 12 m	432	10
6763 59	Matt grey plate 18 m	678	10

* MRP - Maximum Retail Price Inclusive of all taxes.

❖ To be shortly introduced

Red Cat.Nos - new products

NEW!

Modular colour plates with frame

Cat.Nos	Description	MRP* ₹ / Unit	Pack
---------	-------------	------------------	------

Pearl white cover plates

6763 60	Pearl white plate 1 m	116	10/100
6763 61	Pearl white plate 2 m	116	10/100
6763 62	Pearl white plate 3 m	156	10/100
6763 63	Pearl white plate 4 m	168	10/100
6763 64*	Pearl white plate 6 m	214	5/50
6763 65*	Pearl white 8 m plate horizontal	278	5/50
6763 66*	Pearl white plate 4x2 m	280	5/25
6763 67*	Pearl white plate 9 m	326	5/50
6763 68*	Pearl white plate 12 m	398	5/25
6763 69*	Pearl white plate 18 m	626	5/25

Champagne cover plates

6763 70*	Champagne plate 1 m	116	10/100
6763 71*	Champagne plate 2 m	116	10/100
6763 72*	Champagne plate 3 m	156	10/100
6763 73*	Champagne plate 4 m	168	10/100
6763 74*	Champagne plate 6 m	214	5/50
6763 75*	Champagne plate 8 m horizontal	278	5/50
6763 76*	Champagne plate 4x2 m	280	5/25
6763 77*	Champagne plate 9 m	326	5/50
6763 78*	Champagne plate 12 m	398	5/25
6763 79*	Champagne plate 18 m	626	5/25

Silver alu cover plates

6763 80	Silver alu plate 1 m	116	10/100
6763 81	Silver alu plate 2 m	116	10/100
6763 82	Silver alu plate 3 m	156	10/100
6763 83	Silver alu plate 4 m	168	10/100
6763 84	Silver alu plate 6 m	214	5/50
6763 85	Silver alu plate 8 m horizontal	278	5/50
6763 86	Silver alu plate 4x2 m	280	5/25
6763 87	Silver alu plate 9 m	326	5/50
6763 88	Silver alu plate 12 m	398	5/25
6763 89	Silver alu plate 18 m	626	5/25

Dark bronze cover plates

6763 90	Dark bronze plate 1 m	116	10/100
6763 91	Dark bronze plate 2 m	116	10/100
6763 92	Dark bronze plate 3 m	156	10/100
6763 93	Dark bronze plate 4 m	168	10/100
6763 94	Dark bronze plate 6 m	214	5/50
6763 95	Dark bronze plate 8 m horizontal	278	5/50
6763 96	Dark bronze plate 4x2 m	280	5/25
6763 97	Dark bronze plate 9 m	326	5/50
6763 98	Dark bronze plate 12 m	398	5/25
6763 99	Dark bronze plate 18 m	626	5/25

Bold Cat.Nos are products normally available with Legrand (India) Stockists. Cat.Nos that are not bold - delivery within 4 - 8 weeks from the date of order. Bold packing quantity is our mandatory packing. Orders to be placed by Legrand (India) Stockist in multiples of the same.

Mylinc™ boxes



Cat.Nos	Description	MRP* ₹ / Unit	Pack
---------	-------------	------------------	------

Modular white surrounds

6755 81	1 module	42	20/200
6755 82	2 modules	74	20/200
6755 83	3 modules	74	10/100
6755 84	4 modules	108	10/100
6755 86	6 modules (2 column x 3)	154	10/100
6755 89	9 modules (3 column x 3)	270	10/100

Metal flush boxes

6890 07	Flush box - 1/2 modules	90	40
6890 08	Flush box - 3 modules	90	40
6890 09	Flush box - 4 modules	118	40
6890 10	Flush box - 6 modules	186	40
6890 42	Flush box - 8 modules	216	40
6890 31	Flush box - 4 x 2 modules	214	20
6890 29	Flush box - 9 modules	254	20
6890 11	Flush box - 12 modules	324	10
6890 13	Flush box - 16 modules	374	10
6890 12	Flush box - 18 modules	412	10

Plastic surface boxes

6733 02	Surface box- 1/2 modules	86	10/50
6733 03	Surface box- 3 modules	104	5/35
6733 04	Surface box- 4 modules	120	5/25
6733 06	Surface box- 6 modules	152	1/10
6733 08	Surface box- 8 modules	226	1/5
6733 05	Surface box- 4 x 2 modules	218	1/5
6740 99	Surface box- 9 modules	258	1/5

Metal surface boxes

6890 21	Metal surface box- 12 modules (2 rows x 6)	542	1/6
6890 22	Metal surface box- 18 modules (3 rows x 6)	570	1/4

Mylinc™
A little touch of genius

Guarantee

- The Company, at its discretion, will replace products if they have any manufacturing defect within 10 years for switches (without neon lamp) and power sockets. For all other Mylinc™ wiring accessories the guarantee will be 2 years.
- The above guarantee is applicable when the devices are used in Legrand metal flush boxes. Otherwise the guarantee period will be reduced by 50%.
- The guarantee is only applicable when the products are installed as per the Company's instructions and not tampered in any manner.
- The guarantee states the Company's entire liability. It does not extend to cover consequential loss or damage or installation costs arising from defective products.

* MRP - Maximum Retail Price Inclusive of all taxes.
Red Cat.Nos - new products

MYLINC™

Mylinc™

A little touch of genius



Screwless finish & rounded corners



Linc-Loc™



Laser marking



Shockproof sockets-Childsafe



Front Removal



Top orientation arrow



Stripping Template



ISI marking



CE marking

1 lac operations

With a guarantee of 100,000 operations, assuming an average switch is operated 10 times a day, this product is dependable for 27 years.



Finger-proof terminals for IP 20 protection against accidental contact

Bold Cat.Nos are products normally available with Legrand (India) Stockists. Cat.Nos that are not bold - delivery within 4 - 8 weeks from the date of order. Bold packing quantity is our mandatory packing. Orders to be placed by Legrand (India) Stockist in multiples of the same.

NEW!

Britzy™ switches

Cat.Nos	Description	MRP* ₹ / Unit	Pack
---------	-------------	------------------	------

Switches

- All switches are ISI marked as per latest IS 3854:1997
- Finger-proof terminal for protection against accidental contact
- Laser marking for easy identification



6734 01



6734 12



6734 25



6734 04



6734 52



6734 53



6734 54

6734 01	6 A Switch SP 1 way 1 module	56	20/200
6734 02	6 A Switch SP 2 way 1 module	88	20/200
6734 03	6 A Switch SP 1 way with indicator 1 module	86	20/200
6734 11	16 A Switch SP 1 way 1 module	120	20/200
6734 12	16 A Switch SP 2 way 1 module	142	20/200
6734 13	16 A Switch SP 1 way with indicator 1 module	130	20/200
6734 24	25 A Switch SP 1 way with indicator 1 module	168	20/200
6734 25	20 A DP switch with indicator 2 modules	180	10/100
6734 26	32 A DP switch with indicator 2 modules	246	10/100

Push buttons

6734 04	6 A Bell push with indicator 1 module	100	20/200
6734 06	6 A Bell push with indicator 2 module	148	10/100

Sockets

- Confirming to IS 1293:2005
- Shuttered socket for child safety
- Shutter open only with phase and neutral insertion simultaneously

6734 52	6 A 3 pin universal socket 2 modules	102	10/100
6734 53	Euro US socket 1 module	84	20/200
6734 55	6/16 A socket 3 Pin 2 modules	166	10/100
6734 56	25 A socket 3 Pin 2 modules	180	10/100
6734 54	Multistandard socket 2 modules	146	10/100

* MRP - Maximum Retail Price Inclusive of all taxes.
Red Cat.Nos - new products

NEW!

Britzy™ switches

Cat.Nos	Description	MRP* ₹ / Unit	Pack
---------	-------------	------------------	------

Data & voice

6734 41	RJ11 telephone socket 1 module	84	20/200
6734 44	Double RJ11 telephone socket 1 module	124	20/200
6734 45	RJ45 Cat 6 computer socket 1 module	230	20/200



6734 41



6734 44



6734 45



6734 40



6734 31



6734 07



6734 66



6734 77



6734 75



6734 80

Television socket

6734 46	TV socket 1 module	78	20/200
----------------	------------------------------	----	---------------

Buzzer

6734 40	Buzzer 230 V 1 module	256	20/200
----------------	---------------------------------	-----	---------------

Dimmer & regulator

6734 31	Fan regulator 100 W 1 module	350	5/50
6734 30	Fan regulator 100 W 2 modules	444	10/100
6734 33	Light dimmer 400 W 1 module	360	5/50

Bell indicator

6734 07	Bell call indicator 1 module	490	20/200
----------------	--	-----	---------------

Motor starter

6734 66	25 A Motor starter 2 modules	414	10/100
----------------	--	-----	---------------

Skirting light

6734 77	Skirting light 2 modules	346	5/50
----------------	------------------------------------	-----	-------------

Indicator

6734 75	Flat indicator red 1 module	92	20/200
----------------	---------------------------------------	----	---------------

Key card switch

6734 80	16 A Key card switch 2 modules	1838	1/10
6734 83	Keyfob credit card size for 6734 80	146	1/10

Bold Cat.Nos are products normally available with Legrand (India) Stockists. Cat.Nos that are not bold - delivery within 4 - 8 weeks from the date of order. Bold packing quantity is our mandatory packing. Orders to be placed by Legrand (India) Stockist in multiples of the same.

NEW!

Britzy™ switches

Cat.Nos	Description	MRP* ₹ / Unit	Pack
---------	-------------	------------------	------

Do Not Disturb indicator & internal control unit

6734 81	DND internal unit 2 modules	160	10/100
6734 82	DND external unit 2 modules	192	10/100



6734 82

Accessories

6734 71	Cable outlet 1 module	70	20/200
6734 90	Blanking plate 1 module	26	20/200
6734 72	Blanking plate 2 modules	34	10/100

White plates with frame

Sleek and curvy plates with elegant looks comes with sturdy support frame for solid strength



6734 91



6734 92



6734 93



6734 93



6734 96

6734 91	Plate & frame 86 x 86 1 module	60	20/200
6734 92	Plate & frame 86 x 86 2 modules	60	20/200
6734 93	Plate & frame 121 x 86 3 modules	76	10/100
6734 94	Plate & frame 146 x 86 4 modules	82	10/100
6734 96	Plate & frame 224 x 86 6 modules	106	5/50
6734 98	Plate & frame 245 x 86 8 modules	138	5/50
6734 95	Plate & frame 146 x 172 4 x 2 modules	138	5/25
6734 97	Plate & frame 224 x 172 12 modules	204	10
6734 99	Plate & frame 245 x 172 16 modules	222	10
6735 00	Plate & frame 224 x 240 18 modules	272	10

Flush mounting boxes-Metal

- Boxes are with top, bottom, side and back wall knockout for conduit entry from any direction
- Possible to break open knockout without any special tool



6790 60

6890 60	Metal flush box 75.7 x 75.7 x 50.8 1 & 2 modules	64	40
---------	---	----	----

* MRP - Maximum Retail Price Inclusive of all taxes.
Red Cat.Nos - new products

NEW!

Britzy™ switches

Cat.Nos	Description	MRP* ₹ / Unit	Pack
---------	-------------	------------------	------

Flush mounting boxes-Metal

- Boxes are with top, bottom, side and back wall knockout for conduit entry from any direction
- Possible to break open knockout without any special tool



6790 61



6790 63

6890 61	Metal flush box 98.9 x 75.7 x 50.8 3 modules	82	40
6890 62	Metal flush box 136 x 75.7 x 50.8 4 modules	102	40
6890 63	Metal flush box 213.4 x 75.7 x 50.8 6 modules	162	40
6890 64	Metal flush box 136.6 x 136.8 x 61 8 (2 rows x 4) modules	208	20
6890 65	Metal flush box 231.2 x 75.7 x 50.8 8 modules	208	40
6890 66	Metal flush box 215 x 145.3 x 61.2 12 (2 rows x 6) modules	288	10
6890 67	Metal flush box 232.8 x 147.4 x 61.2 16 (2 rows x 8) modules	326	10
6890 68	Metal flush box 215 x 213.3 x 61.2 18 modules	372	10

Surface mounting boxes-Plastic

6890 70	Plastic surface box 86 x 86 x 45 1 & 2 modules	66	10/50
6890 71	Plastic surface box 121 x 86 x 45 3 modules	82	5/35
6890 72	Plastic surface box 146 x 86 x 45 4 modules	102	5/25
6890 73	Plastic surface box 224 x 86 x 45 6 modules	154	1/10
6890 74	Plastic surface box 146 x 172 x 45 8 (2 rows x 4) modules	216	2/10
6890 75	Plastic surface box 245.2 x 86 x 45 8 modules	216	1/10
6890 76	Plastic surface box 224 x 172 x 45 12 (2 rows x 6) modules	264	1/10
6890 77	Plastic surface box 245.2 x 172 x 45 16 (2 rows x 8) modules	312	1/10
6890 78	Plastic surface box 18 modules	334	1/10



6790 70



6790 71



6790 73

Bold Cat.Nos are products normally available with Legrand (India) Stockists. Cat.Nos that are not bold - delivery within 4 - 8 weeks from the date of order. Bold packing quantity is our mandatory packing. Orders to be placed by Legrand (India) Stockist in multiples of the same.

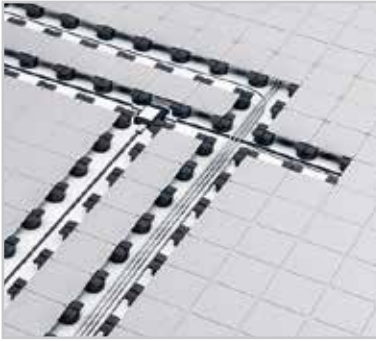

Soluflex cable floor system

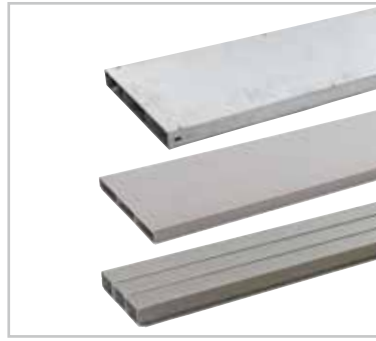

Raceways : PVC & Metal (GI)



Floor boxes



Desktop extension units with wiring devices



Power & data desk grommets



DLP trunking system:
Snap-on, Mini & U-PVC,
Aluminium

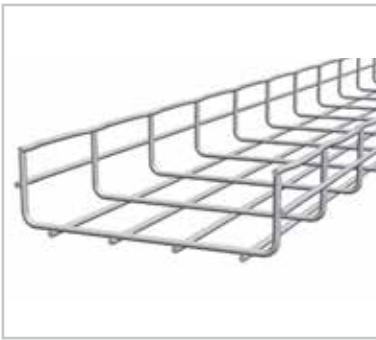

Cablofil wire mesh cable trays



Cable worm



Flush mounting power & data module

Power and data distribution & connection solutions



Raised access floor systems



Screed floor system

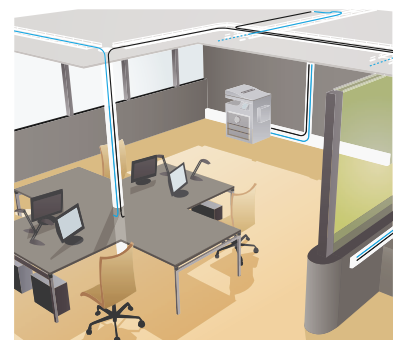

Wall and ceiling systems



Pop-up boxes

Workstation Solutions

Power and data distribution for the office environment

In order to guarantee convenience and performance for users in office buildings, workstations & different areas must be fitted with solutions that can be fully adjusted to different building infrastructures and still meet the user's connectivity and mobility needs.

These ranges of products are solutions for supplying and fitting out workstations in any kind of building infrastructure: Raised Floor, Flush Floor, Screed Floor & False Ceiling & Wall.



Snap-On columns

Legrand's solution for distributing power and data to workstations

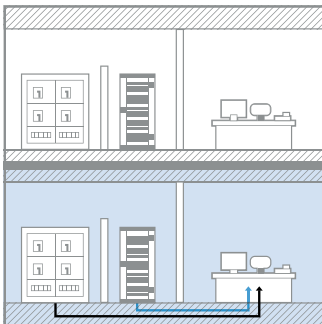

Work station solution supplied through the floor

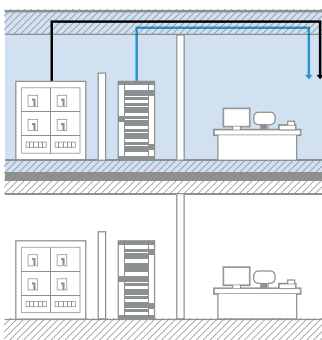

Work station solution supplied through the false ceiling & the wall

Soluflex cable floor system

37 mm height

NEW!

Cat.Nos	Description	LP* ₹ / Unit	Pack
---------	-------------	-----------------	------

Floor parts

Tile

84000 10	Supplied with 4 contact/ distance projections Can be positioned on supports Cat.No 84037 00	444	1
----------	--	-----	---

Support for tile

84037 00	100 x 100 mm support Height 37 mm With 2 grooves for tiles positioning Black - polypropylene	80	1
----------	---	----	---

Edge plates

Used to finish installation against wall
Length 900 mm, width 300 mm
Trim to size on site

84000 60	Double edge plate 2 flanges of 13 mm	3432	1
84000 61	Single edge plate 1 flange of 13 mm	2654	1

Plenum sealing

84037 20	For edging the floor to create a step length 900 mm, width 56 mm, height 37 mm	1684	1
----------	---	------	---

Plenum exterior angle

84037 30	56 x 56 mm	2460	1
----------	------------	------	---

Ramp

84037 40	Length 400 mm, width 112 mm Ramp 10 % Include 1 extra support per tile	2394	1
----------	--	------	---

Earthing tile

84000 20	Supplied with 4 contact/ distance projections Earthing clamp max. 6 mm ² Use 1 tile per 100 m ² or in hallways max. 14 m apart	1460	1
----------	--	------	---

Cable outlet tile

84000 30	For cable access to work station Access 125 x 15 mm Supplied with 4 contact/ distance projections	2180	1
----------	---	------	---

Chromed outlet grommet

81902 32	For cable access to work station To be used with outlet tile Cat.No 84000 40	3496	1
----------	--	------	---

Outlet tile

84000 40	Supplied with 4 contact/ distance projections For integration of columns, pedestals+cable spine or chrome outlet grommet Cat.No 81902 32	2288	1
----------	--	------	---

*LP - List Price Inclusive of excise duty but exclusive of sales tax or any other taxes.

Red Cat.Nos - new products

Soluflex cable floor system

37 mm height

NEW!

Cat.Nos	Description	LP* ₹ / Unit	Pack
---------	-------------	-----------------	------

Floor parts

Fixing brackets

84000 50	For mounting columns on floor with outlet tile Cat.No 84000 40	1648	1
----------	---	------	---

Built-in units to be equipped

225x225 mm, Height 37 mm
(accessory outlet rises to 71 mm)

84037 50	For 2 x 2 module Arteor power sockets Provided with connection terminal	9066	1
84037 51	For up to 4 x 1 module Arteor data sockets	7772	1

Cable worm

0535 98	2 compartments: power and data length: 0.75 m, colour: white	3732	1
---------	--	------	---

Soluflex cable floor system

60 mm height

Floor parts

Tile

84000 10	Supplied with 4 contact/ distance projections Can be positioned on supports Cat.No 84060 00	444	1
----------	--	-----	---

Support for tile

84060 00	100 x 100 mm support Height 60 mm With 2 grooves for tiles positioning Black - polypropylene	98	1
----------	---	----	---

Edge plates

Used to finish installation against wall
Length 900 mm, width 300 mm, Trim to size on site

84000 60	Double edge plate 2 flanges of 13 mm	3432	1
84000 61	Single edge plate 1 flange of 13 mm	2654	1

Plenum sealing

84060 20	For edging the floor to create a step length 900 mm, width 56 mm, height 60 mm	1750	1
----------	---	------	---

Plenum exterior angle

84060 30	56 x 56 mm	2590	1
----------	------------	------	---

Ramp

84060 40	Length 616 mm, width 112 mm Ramp 10 % Include 1 extra support per tile	3500	1
----------	---	------	---

Earthing tile

84000 20	Supplied with 4 contact/ distance projections Earthing clamp max. 6 mm ² Use 1 tile per 100 m ² or in hallways max. 14 m apart	1460	1
----------	--	------	---

Bold Cat.Nos are products normally available with Legrand (India) Stockists. Cat.Nos that are not bold - delivery within 4 - 8 weeks from the date of order. Bold packing quantity is our mandatory packing. Orders to be placed by Legrand (India) Stockiest in multiples of the same.

Soluflex cable floor system

60 mm height

NEW!

Cat.Nos	Description	LP* ₹ / Unit	Pack
---------	-------------	-----------------	------

Floor parts

Cable outlet tile



84000 30

84000 30	Cable outlet tile For cable access to work station Access 125 x 15 mm Supplied with 4 contact/distance projections	2180	1
-----------------	---	------	---

Chromed outlet grommet



81902 32

81902 32	For cable access to work station To be used with outlet tile Cat.No 84000 40	3496	1
-----------------	--	------	---

Outlet tile



84000 40

84000 40	Supplied with 4 contact/distance projections For integration of columns, pedestals + cable spine or chrome outlet grommet Cat.No 81902 32	2288	1
-----------------	---	------	---

Fixing brackets



84000 50

84000 50	For mounting columns on floor with outlet tile Cat.No 84000 40	1648	1
-----------------	---	------	---

Fully submerged units to be equipped

To be combined with cable outlet tile
Cat.No 84000 30



84060 72

84060 72	For 2 x 2 module Arteor power socket Provided with connection terminal	6476	1
84060 73	For 4 x 1 module Arteor data sockets	3240	1

Cable worm



0535 98

0535 98	2 compartments: power and data, length: 0.75 m, colour: white	3732	1
----------------	---	------	---

Soluflex cable floor system

90 mm height

Floor parts

Tile



84000 10

84000 10	Supplied with 4 contact/distance projections Can be positioned on supports Cat.No 84090 00	444	1
-----------------	---	-----	---

Support for tile



84090 00

84090 00	100 x 100 mm support Height 90 mm With 2 grooves for tiles positioning Black - polypropylene	114	1
-----------------	---	-----	---

Edge plates



84000 60



84000 61

Used to finish installation against wall
Length 900 mm, width 300 mm, Trim to size on site

84000 60	Double edge plate 2 flanges of 13 mm	3432	1
84000 61	Single edge plate 1 flange of 13 mm	2654	1

*LP - List Price Inclusive of excise duty but exclusive of sales tax or any other taxes.

Red Cat.Nos - new products

Soluflex cable floor system

90 mm height

NEW!

Cat.Nos	Description	LP* ₹ / Unit	Pack
---------	-------------	-----------------	------

Floor parts

Plenum sealing



84090 20

84090 20	For edging the floor to create a step Length 900 mm, width 56 mm, height 90 mm	1858	1
-----------------	--	------	---

Plenum exterior angle

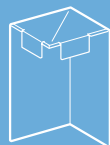

84090 30

84090 30	56 x 56 mm	2788	1
-----------------	------------	------	---

Ramp

84090 40	Length 898 mm, width 112 mm, Ramp 10 % Include 1 extra support per tile	5506	1
-----------------	---	------	---

Earthing tile



84000 20

84000 20	Earthing tile Supplied with 4 contact/distance projections Earthing clamp max. 6 mm ² Use 1 tile per 100 m ² or in hallways max. 14 m apart	1460	1
-----------------	--	------	---

Cable outlet tile



84000 30

84000 30	For cable access to work station Access 125 x 15 mm Supplied with 4 contact/distance projections	2180	1
-----------------	--	------	---

Chromed outlet grommet



81902 32

81902 32	For cable access to work station To be used with outlet tile Cat.No 84000 40	3496	1
-----------------	--	------	---

Outlet tile



84000 40

84000 40	Supplied with 4 contact/distance projections For integration of columns, pedestals+ cable spine or chrome outlet grommet Cat.No 81902 32	2288	1
-----------------	---	------	---

Fixing brackets



84000 50

84000 50	For mounting columns on floor with outlet tile Cat.No 84000 40	1648	1
-----------------	---	------	---

Floor box tile

450 x 450 mm

For lid + trim assemblies



84090 82

84090 82	For 3-compartment floor boxes (square opening 265 x 265 mm)	5540	1
-----------------	--	------	---

Cable worm

0535 98	2 compartments: power and data, Length: 0.75 m Colour: white	3732	1
----------------	---	------	---

Bold Cat.Nos are products normally available with Legrand (India) Stockists. Cat.Nos that are not bold - delivery within 4 - 8 weeks from the date of order. Bold packing quantity is our mandatory packing. Orders to be placed by Legrand (India) Stockiest in multiples of the same.

Soluflex cable floor system

120 mm height

NEW!

Cat.Nos	Description	LP* ₹ / Unit	Pack
---------	-------------	-----------------	------

Floor parts

Tile

84000 10	Supplied with 4 contact/ distance projections Can be positioned on supports Cat.No 84120 00	444	1
----------	--	-----	---

Support for tile

84120 00	100 x 100 mm support Height 120 mm With 2 grooves for tiles positioning Black - polypropylene	226	1
----------	---	-----	---

Edge plates

Used to finish installation against wall
Length 900 mm, width 300 mm, Trim to size on site

84000 60	Double edge plate 2 flanges of 13 mm	3432	1
84000 61	Single edge plate 1 flange of 13 mm	2654	1

Plenum sealing

84120 20	For edging the floor to create a step Length 900 mm, width 56 mm Height 120 mm	1922	1
----------	--	------	---

Plenum exterior angle

84120 30	56 x 56 mm	2916	1
----------	------------	------	---

Ramp

84120 40	Length 1181 mm, width 112 mm Ramp 10 % Include 1 extra support per tile	5942	1
----------	---	------	---

Earthing tile

84000 20	Supplied with 4 contact/ distance projections Earthing clamp max. 6 mm ² Use 1 tile per 100 m ² or in gangways max. 14 m apart	1460	1
----------	--	------	---

Cable outlet tile

84000 30	For cable access to work station Access 125 x 15 mm Supplied with 4 contact/ distance projections	2180	1
----------	---	------	---

Soluflex cable floor system

120 mm height

NEW!

Cat.Nos	Description	LP* ₹ / Unit	Pack
---------	-------------	-----------------	------

Chromed outlet grommet

81902 32	For cable access to work station To be used with outlet tile Cat.No 84000 40	3496	1
----------	---	------	---

Outlet tile

84000 40	Supplied with 4 contact/ distance projections For integration of columns, pedestals+cable spine or chrome outlet grommet Cat.No 81902 32	2288	1
----------	---	------	---

Floor parts

Fixing brackets

84000 50	For mounting columns on floor with outlet tile Cat.No 84000 40	1648	1
----------	--	------	---

Floor box tile

450 x 450 mm
For lid + trim assemblies

84090 82	For 3-compartment floor boxes (square opening 265 x 265 mm)	5540	1
----------	--	------	---

Cable worm

0535 98	2 compartments: power and data Length: 0.75 m Colour: white	3732	1
---------	--	------	---

Raceways and junction boxes

For screed floors

Confirms to EN 50 085 - 2 - 2
Raceways are made from PVC and Galvanised sheet.
Compatible with Cat.6 structured cabling system.

Raceways - PVC

Raceway - PVC - height 25 mm;

Standard length 2 meters*

Price per meter

Can be assembled to obtain multiple compartment configurations

6897 00	75 mm x 25 mm - 1 compartment 150 mm x 25 mm - 2 compartments, use 2x Cat.No 6897 00	856	2/18
6897 01	225 mm x 25 mm - 3 compartments 300 mm x 25 mm - 4 compartments raceways use 1x Cat.No 6897 00 + 1x Cat.No 6897 01	1620	2/80

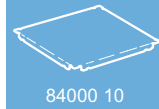

84000 10



84120 00



84000 60



84000 61



84120 20

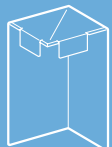

84120 30



84000 20

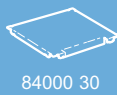

84000 30



81902 32



84000 40



84000 50



84090 82



0535 98



6897 00



6897 01

*LP - List Price Inclusive of excise duty but exclusive of sales tax or any other taxes.

Red Cat.Nos - new products

*No of meters in pack

*To be ordered in multiples of 2 meters

Bold Cat.Nos are products normally available with Legrand (India) Stockists. Cat.Nos that are not bold - delivery within 4 - 8 weeks from the date of order. Bold packing quantity is our mandatory packing. Orders to be placed by Legrand (India) Stockiest in multiples of the same.

Raceways and junction boxes

for screed floors

NEW!

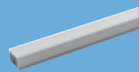

0896 67

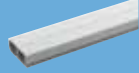

0896 68

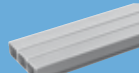

0896 69

Raceways - PVC

**Raceways - PVC - height 38 mm;
Standard length 2 meters⁺
Price per meter**

Cat.Nos	Description	LP* ₹ / Unit	Pack
0896 67	50 mm x 38 mm - 1 compartment	816	12
0896 68	100 mm x 38 mm - 2 compartments	1528	16
0896 69	150 mm x 38 mm - 3 compartments	2294	10

Raceways - Metal / GI

**Raceways - Metal/GI - height 25 mm; length 2.44 m.
Price per unit (One unit is of 2.44 meters)**

6895 10	50 mm x 25 mm - 1 compartment	1486	3/54 ⁽¹⁾
6895 11	75 mm x 25 mm - 1 compartment	1912	3/21 ⁽¹⁾
6895 12	100 mm x 25 mm - 1 compartment	2322	3/54 ⁽¹⁾
6895 13	150 mm x 25 mm - 1 compartment	3218	3/18 ⁽¹⁾
6895 14	225 mm x 25 mm - 3 compartments	5042	3/12 ⁽¹⁾
6895 15	300 mm x 25 mm - 3 compartments	6244	3/18 ⁽¹⁾

**Raceways - Metal/GI - height 38 mm; length 2.44 m
Price per unit (One unit is of 2.44 meters)**

6895 00	50 mm x 38 mm - 1 compartment	1722	3/54 ⁽¹⁾
6895 01	75 mm x 38 mm - 1 compartment	2278	3/21 ⁽¹⁾
6895 02	100 mm x 38 mm - 1 compartment	2756	3/54 ⁽¹⁾
6895 03	150 mm x 38 mm - 1 compartment	3698	3/36 ⁽¹⁾
6895 04	225 mm x 38 mm - 3 compartments	5594	3/12 ⁽¹⁾
6895 05	300 mm x 38 mm - 3 compartments	6858	3/18 ⁽¹⁾

Raceways accessories

Fixing bracket (GI)

For fixing raceways (PVC & Metal) on the floor

6897 09	50 mm x 25 mm (metal)	22	9
6897 10	75 mm x 25 mm (PVC and metal)	38	9
6897 12	100 mm x 25 mm (metal)	46	9
6897 15	150 mm x 25 mm (PVC and metal)	58	9
6897 20	225 mm x 25 mm (PVC and metal)	80	9
6897 30	300 mm x 25 mm (PVC and metal)	108	9



6897 20

Raceways and junction boxes

for screed floors

NEW!

Cat.Nos	Description	LP* ₹ / Unit	Pack
---------	-------------	-----------------	------

Fixing bracket

6897 27	50 mm x 38 mm (PVC and metal)	24	9
6897 28	75 mm x 38 mm (metal)	44	9
6897 37	100 mm x 38 mm (PVC and metal)	52	9
6897 38	150 mm x 38 mm (PVC and metal)	64	9
6897 25	225 mm x 38 mm (metal)	100	9
6897 35	300 mm x 38 mm (metal)	124	9

Riser

6897 23	Vertical - 225 mm width raceways	1716	1
6897 33	Vertical - for 300 mm width raceways	1978	1

Coupler for joining raceways

6897 77	Coupling 38	104	6
6897 79	Coupling 25	78	6

Junction box

For direct access to cables at the intersection of raceways

Supplied completely with base and cover plate (Lid)

Height adjustable junction box 65 - 90 mm

6896 10	150 x 150 x 65 - 90 mm	1874	1
6896 11	225 x 225 x 65 - 90 mm	2324	1
6896 12	300 x 300 x 65 - 90 mm	3122	1
6896 13	400 x 400 x 65 - 90 mm	4636	1

Height adjustable junction box 65 - 90 mm with fly over

For direct access to cables at the intersection of floor raceways while maintaining perfect separation and 90° cross overs between data and power cables

6896 14	225 x 225 x 65 - 90 mm with flyover	2552	1
6896 15	300 x 300 x 65 - 90 mm with flyover	3404	1
6896 16	400 x 400 x 65 - 90 mm with flyover	5100	1

Optional site cover for junction box

6896 18	150 x 150 x 65 - 90 mm with metal cover	210	10
6896 19	225 x 225 x 65 - 90 mm with metal cover	304	10
6896 20	300 x 300 x 65 - 90 mm with metal cover	464	10
6896 21	400 x 400 x 65 - 90 mm with metal cover	698	10

Height adjustable junction box 50 - 70 mm

6896 22	Adj JB 150 x 150 x 50-70 mm	1728	1
6896 23	Adj JB 225 x 225 x 50-70 mm	2122	1
6896 24	Adj JB 300 x 300 x 50-70 mm	2824	1
6896 25	Adj JB 400 x 400 x 50-70 mm	4234	1



6897 23



6897 79

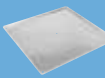

6896 11

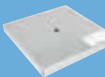

6896 20

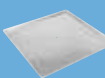

6896 15

*LP - List Price Inclusive of excise duty but exclusive of sales tax or any other taxes.

Red Cat.Nos - new products

*No of meters in pack

(1) Unit of measure in Nos

*To be ordered in multiples of 2 meters

Bold Cat.Nos are products normally available with Legrand (India) Stockists. Cat.Nos that are not bold - delivery within 4 - 8 weeks from the date of order. Bold packing quantity is our mandatory packing. Orders to be placed by Legrand (India) Stockiest in multiples of the same.

Floor boxes for carpet for raised floor, screed floor

NEW!

Cat.Nos	Description	LP* ₹ / Unit	Pack
---------	-------------	-----------------	------

Floor boxes for raised floor

6896 38	Full backbox for raised floor 3 compartments (264x264 mm) height 86 mm	2950	1
6896 31	Lid & trim Grey cover RAL 7031 for 3 compartment floor box with flexible cable exits Size 265 mm x 265 mm	2214	5

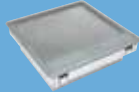

6896 38 +
6896 31

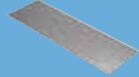

6896 62

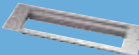

6896 17



6896 78



6896 34 +
6896 31

Support plates for floor boxes 77 mm width plate

6896 62	Blank plates for floor box	422	12
6896 17	Flat support plate 8 module for integration of Myrius/Arteor mechanisms	200	1
6896 78	Waved support plates. For 4 modules (2 x 2 modules)	1166	4

Floor boxes for screed floor (3 Compartment)

6896 34#	Full backbox for screed floor 3 compartments (for ducting upto 225 mm). Height adjustable to screed height 65 to 90 mm	4572	1
6896 31#	Lid & trim Grey cover RAL 7031 for 3 compartment floor box with flexible cable exits. Size 265 mm x 265 mm	2214	5

Support plates for floor boxes 77 mm width plate

6896 62	Blank plates for floor box	422	12
6896 17	Flat support plate 8 module for integration of Myrius/Arteor mechanisms	200	1
6896 78	Waved support plates for 4 modules (2x2 modules)	1166	4

Floor boxes for screed floor (4 Compartment)

6896 45	Full backbox for screed floor 4 compartments (for ducting upto 300 mm). Height adjustable to screed height 65 to 90 mm. To be used with 6896 45	5088	1
6896 41	Lid & trim Grey cover RAL 1019 for 4 compartment floor box with flexible cable exits. To be used with 6896 41	2446	5

Support plates for floor boxes 77 mm width plate

6896 62	Blank plates for floor box	422	12
6896 17	Flat support plate 8 module for integration of Myrius/Arteor mechanisms	200	1
6896 78	Waved support plates for 4 modules (2x2 modules)	1166	4

Stainless steel insert for Lid

For a metal finish on lid
To be used instead of fitting carpet onto the Lid

6896 92	For 3 compartment floor boxes dimension : 245.5x210 mm	2750	1
---------	---	------	---

Floor boxes for tile / marble For screed floor

0896 04	Backbox for screed floor; Screed thickness 65 to 90 mm	3942	1
6896 52	Lid & trim for tiles / marble 15 to 22 mm thickness Stainless steel material AISI 304. 2 cable outlet	19160	1

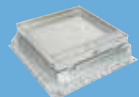

0896 04 +
6896 52

*LP - List Price Inclusive of excise duty but exclusive of sales tax or any other taxes.

Red Cat.Nos - new products

*6896 34 + 6896 31 with support plates and wiring devices

Floor boxes for tile / marble for screed floor

NEW!

Cat.Nos	Description	LP* ₹ / Unit	Pack
---------	-------------	-----------------	------

For screed floor

6896 55	Lid & Trim for tile 8-15 mm thickness Material for head band & single cable outlet - galvanised steel + paint RAL 7031	5252	1
6896 56	Lid & Trim for tile 8-15 mm thickness Material for head band & single cable outlet - stainless steel 304	6404	1

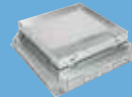

0896 04 +
6896 55

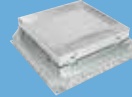

0896 04 +
6896 56

Support plates for floor boxes 77 mm width plate

6896 62	Blank plates for floor box.	422	12
6896 17	Flat support plate 8 module for integration of Myrius/Arteor	200	1
6896 78	Waved support plates. For 4 Modules (2x2 Modules) mechanisms	1166	4

50mm reduced height floor boxes

0880 73	Back Box for Concrete Floor (to be used with 088070)	5828	1
0880 70	Lid and Trim for Screed Floor between 50 and 70 mm. With Cover for carpet; grey RAL 7031 Can be equipped with SS finishing plate 088072 16 Module	5754	1
0880 72	Stainless Steel finishing plate for 50 mm floor box	3586	1

Floor boxes 3 module for screed floor and raised floor

Floor service outlet boxes - 3 modules

0896 44	Floor service outlet box - 3 modules. Grey RAL 7031. To be equipped with Arteor Mechanism	1218	1
0896 49	Flush mounting box for concrete for Cat.No 0896 44	812	1



0896 44



0896 49

IP 66 Floor box - 4 module

Conform to EN 60-670-1 and EN 60670-23 standards (when lid is closed) / IP55 (with cable exit accessory Cat.No 088062)

0880 60	IP66/IK09 screwed brass floor box (with removable lid); can be equipped with cable exit accessory Cat.No 0880 62	13288	1
0880 61	IP66/IK09 screwed stainl. steel floor box (with removable lid); can be equipped with cable exit accessory Cat.No 0880 62	13288	1
0880 63	IP66/IK09 hinged cover brass floor box	15988	1
0880 64	IP66/IK09 hinged cover stainl. steel floor box	15988	1
0880 69	Auto adjustable back box for installing IP66 floor boxes in concrete floors; supplied with cover; accepts conduit dia 20mm; min screed height 65 mm	2550	1
0880 62	IP55 cable exit accessory	14664	1



0880 60



0880 61



0880 63



0880 64

Bold Cat.Nos are products normally available with Legrand (India) Stockists. Cat.Nos that are not bold - delivery within 4 - 8 weeks from the date of order. Bold packing quantity is our mandatory packing. Orders to be placed by Legrand (India) Stockiest in multiples of the same.

Heavy duty in-screed floor box for screed floors

NEW!

Cat.Nos	Description	LP* ₹ / Unit	Pack
---------	-------------	-----------------	------

Metal in-screed floor box

0896 34	Universal metal in-screed backbox	16006	1
---------	-----------------------------------	-------	---

Accessories for metal in-screed floor box

0896 83	Normal load support upto 8 KN load with deflection <6 mm	16006	1
0896 84	Heavy load support upto 20 KN load with deflection <3 mm	27062	1

Plates for metal in-screed floor boxes

0896 85	IP 66 plain cover (cover closed) access trap for junction. No cable exit	27830	1
---------	--	-------	---

Heavy duty in screed floor box with cable exit

0896 34	Metal in-screed floor box	16006	1
---------	---------------------------	-------	---

Accessories for metal in screed floor box

0896 83	Normal load support upto 8 KN load with deflection <6 mm	16006	1
0896 84	Heavy load support up to 20 KN load with deflection <3 mm	27062	1

Plates for metal in-screed floor boxes

0896 86	IP 66 plate (cover closed and plugs not connected) with central cable exit	55712	1
0896 87	IP 14 Cable exit accessory for IP66 cover plate Cat.No 0896 86 be used as a simple access to the floor void	29772	1

Over Floor Trunking

Conform to std EN 50085-2-2; For creating a link between trunking, column, mini-column, floor units or protecting cables on passageways Supplied with cover

0300 92	Over floor trunking 50x12 mm; length 2 m, supplied with cover; 3 Compartments; Capacity 1: Max Dia 9 mm, Capacity 2: Max Dia 6 mm; ral 7030	390	54
0300 11	Flat angle/floor 50X12	156	10
0300 12	Cover joint/floor 50X12	196	10
0300 93	Over floor trunking 75x18 mm; length 2 m, supplied with cover; 3 compartments; 1: max dia 14mm, capacity 2: max dia 11mm; ral 7030	538	36
0300 18	Flat angle/floor 75X18	296	10
0300 19	Cover joint/floor 50X12	206	10
0328 00	Over floor trunking 92x20 mm; Length 2 m, supplied with cover; 4 Compartments, equipped with 2 adhesive strips for better floor fixing; capacity 1: max. Ø14.5 mm; capacity 2: max. Ø9.5 mm; ral 7016	988	20
0328 07	End cap for floor duct 92x20	172	10
0328 03	Cover joint for floor duct 92x20	232	10
0328 02	Flat angle for floor duct 92x2	426	5

*LP - List Price Inclusive of excise duty but exclusive of sales tax or any other taxes.

Red Cat.Nos - new products

*No of meters in pack

(1) Unit of measure in Nos

*To be ordered in multiples of 2 meters

Floor access unit

For raised floors

Cat.Nos	Description	MRP* ₹ / Unit	Pack
---------	-------------	------------------	------

IP 20 - IK 08

0893 07	Access master box circular floor box that can be used as a simple access to the floor void	5688	1
---------	--	------	---

Pop-up type flush-mounting boxes for workstation & meeting room table applications

Pop-up boxes to be equipped

Slim design for perfect integration into the floor or office furniture

Soft opening for enhanced comfort and safety Equipped with "push and slide" locking system to avoid accidental opening by feet

To be equipped with Arteor/Myrius socket outlets For installation use the flush-mounting boxes for concrete floors or the kits for raised access floors or table top

3 modules

0540 10	Matt aluminium finish	1960	1
0540 15	Brushed brass	2712	1
0540 20	Brushed Stainless steel finish	2742	1

4 modules

0540 11	Matt aluminium finish	2350	1
0540 16	Brushed brass	3208	1
0540 21	Brushed Stainless Steel finish	3294	1
0540 26	Matt black	2900	1
0540 31	Glossy white	2970	1

6 (2 x 3) modules

0540 12	Matt aluminium finish	4350	1
0540 17	Brushed brass	5822	1
0540 22	Brushed stainless steel finish	6034	1

8 (2 x 4) modules

0540 13	Matt aluminium finish	5222	1
0540 18	Brushed brass	6986	1
0540 23	Brushed stainless steel finish	7242	1
0540 28	Matt black	6382	1
0540 33	Glossy white	6536	1

Retractable Accessory for Pop Up

0540 34	Retract RJ 45 kit cord C6UTP white	2632	1
0540 35	Retract RJ 45 kit cord C6FTP white	3682	1
0540 36	Retractable kit USB cord white	2494	1

Installation kits for raised access floors or table top

Include an empty receptacle and fixing brackets for raised access floor tiles or table tops

Equipped with cable retainer for power cables, to ensure increased safety of the installation

Compatible with:

- Cat. 6 data cabling
- Audio/video cabling

0540 05	3 modules	884	1
0540 07	6 (2 x 3) modules	1474	1
0540 06	4 modules	1032	1
0540 08	8 (2 x 4) modules	1764	1

Bold Cat.Nos are products normally available with Legrand (India) Stockists. Cat.Nos that are not bold - delivery within 4 - 8 weeks from the date of order. Bold packing quantity is our mandatory packing. Orders to be placed by Legrand (India) Stockiest in multiples of the same.

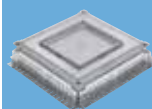

0896 34 +
0896 83 +
0896 85



0896 34 +
0896 83 +
0896 86 +
0896 87



0300 92



0300 93

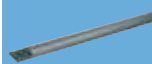

0328 00



0893 07



0540 15



0540 16

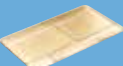

0540 17



0540 13



0540 18



0540 18



0540 23

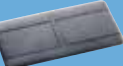

0540 28



0540 33



0540 34

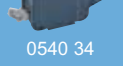

0540 36



0540 36



0540 06



0540 06

Pop-up type flush-mounting boxes for workstation & meeting room table applications

Cat.Nos	Description	LP* ₹ / Unit	Pack
---------	-------------	-----------------	------

Flush-mounting boxes for installation in concrete floors

For installation of pop-up floor boxes in concrete floors Equipped with knockouts for Ø 20 and Ø 25 mm conduits

Metal flush-mounting boxes

0540 00	3 modules	234	1
0540 02	6 (2 x 3) modules	500	1
0540 01	4 modules	312	1
0540 03	8 (2 x 4) modules	624	1



0540 00

NEW! Power & data desk grommets for workstation & meeting room table application

Empty power & data desk grommets

To be equipped with Myrius or Arteor socket outlets, Easily retro fitted into a 60 to 80 mm diameter hole in current office desks and workspace table tops (by replacing the desk grommet)
Cover opens to 180° angle to prevent breaking

For one 2P+E socket

0540 70 [▲]	White RAL 9003, to be equipped with 1 socket	1634	1
0540 71 [▲]	Black RAL 9017, to be equipped with 1 socket	1516	1



0540 70
+ 0540 60



0540 73
+ 0540 62



0540 73

For one 2P+E socket and USB phone charger

Supplied with one USB phone charger output 5 V= 750 mA, to be wired

0540 72 [▲]	White RAL 9003 with USB, to be equipped with 1 socket	3902	1
0540 73 [▲]	Black RAL 9017 with USB, to be equipped with 1 socket	4250	1

Pre-wired modules with retractable cords

For fitting on an empty power & data desktop modules (under the table top)
Automatic cable rewind when not connected, for an optimized use of the desk surface

Cat. 6 FTP

0540 65	Equipped with: - 1.35 m RJ 45 Cat. 6 FTP retractable cord on the user side and - 1 x RJ 45 socket on the installation side Patch cord for connection to data network to be ordered separately	2388	1
---------	--	------	---



0540 65

USB / micro USB

0540 67	Equipped with- 1.35 m retractable cord with micro USB connector, on the user side and - 0.5 m cable with USB connector on the installation side	2164	1
---------	---	------	---



0540 67



0540 60



0540 62

Finishing plates for empty power & data desk grommets

For fitting on an empty power & data desk grommets

0540 60	White RAL 9003	238	10
0540 62	Black RAL 9017	260	10
0540 63	Stainless Steel	948	10

*LP - List Price Inclusive of excise duty but exclusive of sales tax or any other taxes.

Red Cat.Nos - new products

▲ Finishing Plates to be ordered separately

Desktop multi-outlet extensions

Cat.Nos	Description	LP* ₹ / Unit	Pack
---------	-------------	-----------------	------

- Aluminium extensions with grey end caps RAL 7035. Reversible cable guide for grouping cords of connected devices
- Designed to have 45° Slope for easy insertion of angled plug
- An ideal solution dedicated to nomadic people and / or satisfy a esthetic needs
- Products answering all needs of office users
- Possibility to organise cables and plugs through the cable guide (reversible if not used)
- A specific accessory allowing to fit the product on the desk in 3 different position
- A reliable and secure installation with conformity to NFC 61-314
- Index of protection: IK7

Empty desktop multioutlet extensions

Aluminium extensions with cable guide (reversible)
To be equipped with Arteor sockets

0535 90	8 modules	3714	1
0535 91	12 modules	4188	1
0535 92	16 modules	5000	1



0535 90



0535 91



0535 99

Accessories

Fixing accessory

0535 99	Fixing accessory to clip on desktop	2164	1/5
---------	-------------------------------------	------	-----

Cable worm

0535 98	2 compartments Length: 0.75 m White colour Very suitable solution for a safe and design protection of the cabling between desk and floor	3732	1
---------	--	------	---



0535 98

NEW! Flush mounting power and data module

A ready to embed solution for all dry support with thickness between 2 and 40 mm. Conform to standard NFC 61-314 which ensures safety of the user
Aesthetic product (no visible screw), thickness of 6mm only. Product available in 8 and 12 module, with the option of configuring power sockets, data, AV, protection etc. 3 Finishes; white/ black and aluminium

Flush mounting power and data module to be equipped

Aluminium extensions with cable guide (reversible)
To be equipped with Arteor sockets

8 module; length - 180 mm

0535 60	Flush 8 module white finish	4268	1
0535 61	Flush 8 module aluminium finish	5030	1
0535 62	Flush 8 module black finish	4150	1



0535 60

Flush mounting power and data module

12 module; length - 270 mm

0535 63	Flush 12 module white finish	4486	1
0535 64	Flush 12 module aluminium finish	5406	1
0535 65	Flush 12 module black finish	4526	1

Bold Cat.Nos are products normally available with Legrand (India) Stockists. Cat.Nos that are not bold - delivery within 4 - 8 weeks from the date of order. Bold packing quantity is our mandatory packing. Orders to be placed by Legrand (India) Stockiest in multiples of the same.

Snap-on trunking 45 mm cover 50x80 routing sections and accessories

Cat.Nos	Description	LP* ₹ / Unit	Pack
Snap-on trunking			
1-compartment trunking			
0756 01	Snap-on trunking can take any Arteor wiring accessory Includes: - 1 body - 1 cover, width 45 mm	868	20 ⁽¹⁾
Extra cover			
0756 08	Width 45 mm	336	20 ⁽¹⁾
Extra partition			
0756 09	Divider	188	26 ⁽¹⁾
Fishplate body joint			
0756 61	Used to join 2 bodies and simplifies fixing sections to the wall - set of 2	302	10
Joint			
0756 66	Stick-on body joint	194	20
Cover joint			
0756 69	Cover joint, width 45 mm	106	10
Height spacer			
0105 80	Colour charcoal grey For fitting 15 mm from the ground	436	24 ⁽¹⁾
Soluclip accessory			
0756 90	For installation with any Arteor function	150	10
Angles			
0756 21	Internal angle, varies from 80° to 100°	402	10
0756 31	External angle, varies from 85° to 120°	830	10
0756 41	Flat angle at 90°	490	10
End caps			
0756 11	Left or right end cap	174	10
Flat junctions			
With 80 mm wide sections			
0756 71	Creates a junction with snap-on trunking 50 x 80 mm	670	5
Angled junction			
0756 81	Creates a junction in an internal angle with snap-on trunking 50 x 80, Must be used in conjunction with internal angle	1478	5
Junction with floor duct			
0756 88	Creates a junction with a floor duct size 50 x 12 mm or 92 x 20 mm	772	5

Snap-on trunking 45mm cover 50x105 routing sections and accessories

Cat.Nos	Description	LP* ₹ / Unit	Pack
Snap-on trunking			
1-compartment trunking			
0756 02	Snap-on trunking can take any Arteor wiring accessory Includes: - 1 body - 1 cover, width 45 mm	1102	12 ⁽¹⁾
Extra cover			
0756 08	Width 45 mm	336	20 ⁽¹⁾
Extra partition			
0756 09	Divider	188	26 ⁽¹⁾
Fishplate body joint			
0756 62	Used to join 2 bodies and simplifies fixing sections to the wall - set of 2	402	10
Joint			
0756 67	Stick-on body joint	236	20
Cover joint			
0756 69	Cover joint, width 45 mm	106	10
Height spacer			
0105 80	Colour charcoal grey For fitting 15 mm from the ground	436	24 ⁽¹⁾
Soluclip accessory			
0756 90	For installation with any Arteor function	150	10
Angles			
0756 22	Internal angle, varies from 80° to 100°	560	10
0756 32	External angle, varies from 85° to 120°	1278	10
0756 42	Flat angle at 90°	642	10
End caps			
0756 12	Left or right end cap	174	10
Flat junctions			
With 80 mm wide sections			
0756 72	Creates a junction with snap-on trunking 50 x 80 mm	670	5
With 105 mm wide sections			
0756 76	Creates a junction with snap-on trunking 50 x 105 mm	718	5
Angled junction			
0756 81	Creates a junction in an internal angle with snap-on trunking 50 x 80, 50 x 105 mm, 50 x 130 mm Must be used in conjunction with internal angle	1478	5
Junction with floor duct			
0756 88	Creates a junction with a floor duct size 50 x 12 mm or 92 x 20 mm	772	5

*LP - List Price Inclusive of excise duty but exclusive of sales tax or any other taxes.

(1) Price in Meters; No of meters in Pack, Standard length 2 meters to be ordered in multiples of 2 meters

Bold Cat.Nos are products normally available with Legrand (India) Stockists. Cat.Nos that are not bold - delivery within 4 - 8 weeks from the date of order. Bold packing quantity is our mandatory packing. Orders to be placed by Legrand (India) Stockiest in multiples of the same.

Snap-on trunking 45mm cover 50x130 routing sections and accessories

Cat.Nos	Description	LP* ₹ / Unit	Pack
Snap-on trunking			
2-compartment trunking			
0756 03	Snap-on trunking Can take any Arteor wiring accessory Includes: - 1 body with 2 compartments - 2 covers, width 45 mm	1518	12 ⁽¹⁾
Extra cover			
0756 08	Width 45 mm	336	20 ⁽¹⁾
Fishplate body joint			
0756 61	Used to join 2 bodies and simplifies fixing sections to the wall - set of 2	302	10
Stick-on body joint			
0756 66	For top part of body	194	20
Cover joint			
0756 69	Cover joint, width 45 mm	106	10
Height spacer			
0105 80	Colour charcoal grey For fitting 15 mm from the ground	436	24 ⁽¹⁾
Soluclip accessory			
0756 90	For installation with any Arteor function	150	10
Angles			
0756 23	Internal angle, varies from 80° to 100°	940	5
0756 33	External angle, varies from 85° to 120°	1734	5
0756 43	Flat angle at 90°	1278	5
End caps			
0756 13	Left or right end cap	288	5
Flat junctions			
For 80 mm wide downward trunking			
0756 71	Creates a junction with snap-on trunking 50 x 80 mm	670	5
For 105 mm wide upward trunking			
0756 75	Creates a junction with snap-on trunking 50x105 mm	654	5
Angled junction			
0756 81	Creates a junction in an internal angle with snap-on trunking 50 x 80, 50 x 105 mm, 50 x 130 mm Must be used in conjunction with internal angle	1478	5
Junction with floor duct			
0756 88	Creates a junction with a floor duct size 50 x 12 mm or 92 x 20 mm	772	5

*LP - List Price Inclusive of excise duty but exclusive of sales tax or any other taxes.

(1) Price in Meters; No of meters in Pack, Standard length 2 meters to be ordered in multiples of 2 meters

Snap-on trunking 45mm cover 50x145 routing sections and accessories

Cat.Nos	Description	LP* ₹ / Unit	Pack
Snap-on trunking			
2-compartment trunking			
0756 04	Snap-on trunking Can take any Arteor wiring accessory Includes: - 1 body with 2 compartments - 2 covers, width 45 mm	1950	8 ⁽¹⁾
Extra cover			
0756 08	Width 45 mm	336	20 ⁽¹⁾
Fishplate body joint			
0756 63	Used to join 2 bodies and simplifies fixing sections to the wall - set of 2	348	10
Stick-on body joint			
0756 66	For top part of body	194	20
0756 67	For bottom part of body	236	20
Cover joint			
0756 69	Cover joint, width 45 mm	106	10
Height spacer			
0105 80	Colour charcoal grey, For fitting 15 mm from the ground	436	24 ⁽¹⁾
Soluclip accessory			
0756 90	For installation with any Arteor function	150	10
Angles			
0756 24	Internal angle, varies from 80° to 100°	1506	5
0756 34	External angle, varies from 85° to 120°	2044	5
0756 44	Flat angle at 90°	1196	5
End caps			
0756 14	Left or right end cap	296	5
Flat junctions			
For 80 mm wide downward trunking			
0756 72	Creates a junction with snap-on trunking 50x80mm	670	5
For 80 mm wide upward trunking			
0756 71	Creates a junction with snap-on trunking 50x80 mm	670	5
For 105 mm wide downward trunking			
0756 76	Creates a junction with snap-on trunking 50x105 mm	718	5
For 105 mm wide upward trunking			
0756 75	Creates a junction with snap-on trunking 50x105 mm	654	5
Angled junction			
0756 81	Creates a junction in an internal angle with snap-on trunking 50x80, 50x105 mm, 50x130 mm Must be used in conjunction with internal angle	1478	5
Junction with floor duct			
0756 88	Creates a junction with a floor duct size 50 x 12 mm or 92 x 20 mm	772	5

Bold Cat.Nos are products normally available with Legrand (India) Stockists. Cat.Nos that are not bold - delivery within 4 - 8 weeks from the date of order. Bold packing quantity is our mandatory packing. Orders to be placed by Legrand (India) Stockiest in multiples of the same.

Snap-on trunking 45mm cover 50x180 routing sections and accessories

Cat.Nos	Description	LP* ₹ / Unit	Pack
---------	-------------	-----------------	------

Snap-on trunking

3-compartment trunking

0756 06	Snap-on trunking Can take any Arteor wiring accessory Includes: - 1 body with 3 compartments - 3 flexible covers, width 45 mm	2156	8 ⁽¹⁾
---------	---	------	------------------

Extra cover

0756 08	Width 45 mm	336	20 ⁽¹⁾
---------	-------------	-----	-------------------

Fishplate body joint

0756 61	Used to join 2 bodies and simplifies fixing sections to the wall - set of 2	302	10
---------	---	-----	----

Stick-on body joint

0756 66	For top part of body	194	20
---------	----------------------	-----	----

Cover joint

0756 69	Cover joint, width 45 mm	106	10
---------	--------------------------	-----	----

Height spacer

0105 80	Colour charcoal grey For fitting 15 mm from the ground	436	24
---------	--	-----	----

Soluclip accessory

0756 90	For installation with any Arteor function	150	10
---------	--	-----	----

Angles

0756 26	Internal angle, varies from 80° to 100°	1332	5
0756 36	External angle, varies from 85° to 120°	2424	5
0756 46	Flat angle at 90°	2398	5

End caps

0756 16	Left or right end cap	328	5
---------	-----------------------	-----	---

Flat junctions

With 80 mm wide sections

0756 71	Creates a junction with snap-on trunking 50 x 80 mm	670	5
---------	---	-----	---

With 105 mm wide sections

0756 75	Creates a junction with snap-on trunking 50 x 105 mm	654	5
---------	--	-----	---

Angled junction

0756 81	Creates a junction in an internal angle with snap-on trunking 50 x 80, 50 x 105 mm, 50 x 130 mm Must be used in conjunction with internal angle	1478	5
---------	---	------	---

Junction with floor duct

0756 88	Creates a junction with a floor duct size 50 x 12 mm or 92 x 20 mm	772	5
---------	---	-----	---

DLP U-PVC trunking system mini-trunking system

Cat.Nos	Description	LP* ₹ / Unit	Pack
---------	-------------	-----------------	------

Mini-trunking - 32 x 12.5 mm

0300 15	Without central partition	106	80 ⁽¹⁾
---------	---------------------------	-----	-------------------

Finishing accessories

0312 03	End cap right or left	50	20/400
0302 51	Changeable internal- external angle from 60° to 120°	70	10/100
0302 53	Changeable flat angle from 85° to 95°	78	10/100
0302 54	Flat junction	100	10/200
0336 03	White 32x10/12.5 Cover Gasket	98	20

Mini-trunking - 32 x 16 mm

0308 04	Without central partition	124	60 ⁽¹⁾
---------	---------------------------	-----	-------------------

Finishing accessories

0312 07	End cap right or left	74	10
0333 25	Changeable internal- external angle from 60° to 120°	84	10
0333 27	Changeable flat angle from 85° to 95°	82	10
0333 30	Flat junction	116	10
0336 04	White 32x16/20 Cover Gasket	98	20

Mini-trunking - 32 x 20 mm

0300 17	Without partition	146	50 ⁽¹⁾
---------	-------------------	-----	-------------------

Finishing accessories

0312 09	End cap right or left	108	10
0302 71	Changeable internal- external angle from 60° to 120°	100	10
0302 73	Changeable flat angle from 85° to 95°	84	10
0302 74	Flat junction	98	10
0336 04	White 32x16/20 Cover Gasket	98	20

DLP U-PVC trunking system and accessories 80 x 50

Trunking and fittings

Trunking

Bodies

0104 12	Supplied without cover 80 x 50 mm	546	20 ⁽¹⁾
---------	--------------------------------------	-----	-------------------

Flexible cover

0105 21	Fits onto the whole branch including in internal or external angles	268	24 ⁽¹⁾
---------	--	-----	-------------------

Partitions

0105 82	Separation partition for 80 x 50 trunking	180	24 ⁽¹⁾
---------	--	-----	-------------------

Joints

0106 91	Body joint, for aligning bases during installation	60	20
0108 01	Cover joint	108	10

*LP - List Price Inclusive of excise duty but exclusive of sales tax or any other taxes.

(1) Price in Meters; No of meters in Pack, Standard length 2 meters to be ordered in multiples of 2 meters

Bold Cat.Nos are products normally available with Legrand (India) Stockists. Cat.Nos that are not bold - delivery within 4 - 8 weeks from the date of order. Bold packing quantity is our mandatory packing. Orders to be placed by Legrand (India) Stockiest in multiples of the same.

DLP U-PVC trunking system and accessories 80 x 50

trunking and fittings

Cat.Nos	Description	LP* ₹ / Unit	Pack
Angles and end caps			
Internal and external angles			
Include the 2 components for the top and bottom of the trunking on which the flexible cover is fitted			
0106 02	Internal angle, adjustable from 80° to 100°	378	10
0106 22	External angle, adjustable from 60° to 120°	380	10
0107 67	Flat angle - 90° flat angle	516	10
0107 22	End cap - Left or right end cap	150	10
Junctions			
0107 32	Flat junctions to tap-off to a branch smaller than 50 x 105	692	10
0107 35	For specific size tap-off to 80 mm wide branch	404	5
Accessories			
Holding cables in place			
0106 82	Clip	52	50
VDI accessories			
0107 80	For internal angles	576	5/50
0107 81	For external angles	618	5/50
0107 82	For flat angles	658	5/50
0107 83	For flat junctions	794	5/50
Additional accessories			
0106 98	Wall crossing for trunking 80 to 150 mm width	660	5/25
0308 81	Cable tie base	24	100/1000
0111 88	Earthing link	252	20/500
Capacity change			
Allows to increase 15mm height of trunking to preserve the space of wiring with a flat junction or a support equipment			
0106 87	Raise, length 57 cm	240	40
0106 88	Set of 4 accessories to change capacity of the body	300	10/100
0106 89	Set of 2 accessories of change height of partition (to be used only on trunking with multi compartments)	302	5/50
Supports for mounting wiring accessories			
Arteor™ supports			
Clip-on supports which can be fitted side by side Supplied with finishing plate			
0109 21	2 modules	130	20
0109 31	3 modules	184	5/50
0109 41	4 modules	196	10/50
0109 61	6 modules	232	5/25
0109 27	Insulation unit for 2 modules (Arteor™) can be fitted together to create 4/6 module supports	234	10/100
0109 37	Insulation unit for 3 modules (Arteor™) supports	276	5/50
Legrand Lexic support			
0109 25	2 modules	810	5

*LP - List Price Inclusive of excise duty but exclusive of sales tax or any other taxes.

Red Cat.Nos - new products

(1) Price in Meters; No of meters in Pack, Standard length 2 meters to be ordered in multiples of 2 meters

DLP U-PVC trunking system and accessories 105 x 50

trunking and fittings

Cat.Nos	Description	LP* ₹ / Unit	Pack
Trunking			
Bodies			
0104 22	Supplied without cover 105 x 50 mm	678	20 ⁽¹⁾
Flexible cover			
Fits onto the whole branch including in internal or external angles			
0105 22	Full cover width 85 mm	304	20 ⁽¹⁾
0105 20	Full covers width 40 mm	270	20 ⁽¹⁾
Partitions			
0105 82	Separation partition for 105 x 50 trunking	180	24 ⁽¹⁾
0104 72	Plastic clip-on partition	266	48 ⁽¹⁾
0111 06	Aluminium clip-on partition	1032	12 ⁽¹⁾
Joints			
0106 91	Body joint For aligning bases during installation	60	20/200
0108 02	Cover joint for 85 mm width	164	10/100
0108 00	Cover joint for 40 mm width	124	10/100
Angles and end caps			
Internal and external angles Include the 2 components for the top and bottom of the trunking on which the flexible cover is fitted			
0106 02	Internal angle, adjustable from 80° to 100°	378	10/40
0106 22	External angle, adjustable from 60° to 120°	380	10/50
0107 85	Flat angle - 90° flat angle	538	10
0107 02	End cap Left or right end cap	140	20/100
Junctions			
0107 32	Flat junction to tap-off a branch smaller than 50 x 105	692	10
0107 35	For tap-off to an 80 mm wide branch	404	5/25
0107 36	For tap-off to an 105 mm wide branch equipped with an 85 mm cover	398	5/25
Partion junction			
0106 11	For internal angles	232	5/50
0106 32	For external angles	348	5/50
0107 42	For flat angles	828	5/25
Accessories			
Holding cables in place			
0106 82	Clip	52	50
VDI accessories			
0107 80	For internal angles	576	5/50
0107 81	For external angles	618	5/50
0107 82	For flat angles	658	5/50
0107 83	For flat junctions	794	5/50

Bold Cat.Nos are products normally available with Legrand (India) Stockists. Cat.Nos that are not bold - delivery within 4 - 8 weeks from the date of order. Bold packing quantity is our mandatory packing. Orders to be placed by Legrand (India) Stockiest in multiples of the same.

DLP U-PVC adaptable trunking system 105 x 50

DLP mini trunking



Cat.Nos	Description	LP* ₹ / Unit	Pack
---------	-------------	-----------------	------

Accessories

Additional accessories

0106 98	Wall crossing for trunking 80 to 150 mm width	660	5/25
0308 81	Cable tie base	24	100/1000
0111 88	Aluminium earthing link	252	20/500

Capacity Change

Allows to increase 15mm height of trunking to preserve the space of wiring with a flat junction or a support equipment

0106 87	Raise, length 57cm	240	40
0106 88	Set of 4 accessories to change capacity of the body	300	10/100
0106 89	Set of 2 accessories of change height of partition (to be used)	302	5/50

Supports for mounting wiring accessories

Arteor™ supports

Clip-on supports which can be fitted side by side
Supplied with finishing plate

0109 10	1 modules-for 40 mm cover	138	5/50
0109 22	2 modules-for 85 mm cover	136	20
0109 32	3 modules-for 85 mm cover	192	5/50
0109 42	4 modules-for 85 mm cover	196	20
0109 62	6 modules-for 85 mm cover	264	10
0109 27	Insulation unit for 2 modules (Arteor™) can be fitted together to create 2/4/6 module supports	234	10/100
0109 37	Insulation unit for 3 modules (Arteor™) supports	276	5/50

Legrand Lexic supports

0109 35	3 modules	962	5
---------	-----------	-----	---

DLP U-PVC adaptable trunking system and accessories 150 x 50

Trunking and fittings

Trunking

Bodies

Supplied without cover

0104 32	150 x 50 mm	1150	10 ⁽¹⁾
---------	-------------	------	-------------------

Flexible cover

Fits onto the whole branch including in internal or external angles

0105 24	Full cover width 130 mm	642	8
0105 22	Full cover width 85 mm	304	20
0105 21	Full cover width 65 mm	268	24
0105 20	Full cover width 40 mm	270	20

Partitions

0105 82	Separation partition for 105 x 50 trunking	180	24 ⁽¹⁾
0104 72	Plastic clip-on partition	266	48
0111 06	Aluminium clip-on partition	1032	12

Joints

0106 91	Body joint - For aligning bases during installation	60	20/200
0108 04	Cover joint for 130 mm width	272	10/100
0108 02	Cover joint for 85 mm width	164	10/100
0108 01	Cover joint for 65 mm width	108	10/100
0108 00	Cover joint for 40 mm width	124	10/100

*LP - List Price Inclusive of excise duty but exclusive of sales tax or any other taxes.

(1) Price in Meters; No of meters in Pack, Standard length 2 meters to be ordered in multiples of 2 meters

Cable-grip

It makes the installation easier and faster by containing all the wires inside the trunking body before the cover is clipped

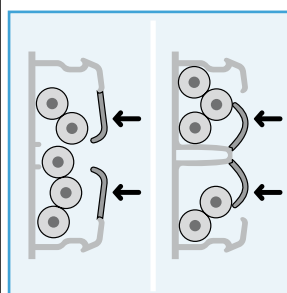

Comfortable implementation

- During installation, the conductors stay in place in the 1 compartment mini-trunking thanks to cable-grip membranes



Speed of installation

- Cable holding is integrated with the trunking (no staple to add)
- Easy conductors position
- Quick cover fitting

Bold Cat.Nos are products normally available with Legrand (India) Stockists. Cat.Nos that are not bold - delivery within 4 - 8 weeks from the date of order. Bold packing quantity is our mandatory packing. Orders to be placed by Legrand (India) Stockiest in multiples of the same.

DLP U-PVC trunking system and accessories 150 x 50 trunking and fittings

Cat.Nos	Description	LP* ₹ / Unit	Pack
Angles and end caps			
Internal and external angles Include the 2 components for the top and bottom of the trunking on which the flexible cover is fitted			
0106 02	Internal angle, adjustable from 80° to 100°	378	10/40
0106 22	External angle, adjustable from 60° to 120°	380	10/50
Flat angle			
0107 89	900 flat angle	1786	5
End cap			
0107 06	Left or right end cap	270	10/50
Junctions			
0107 32	Flat junction to tap-off a branch smaller than 50 x 105 To tap-off a branch of 150 x 50, use 2 nos of 0107 32 (2 x 0107 32)	692	10
0107 35	To tap-off to an 80 mm wide branch	404	5/25
0107 36	To a tap-off to a 105 mm wide branch equipped with a 85 mm cover	398	5/25
0107 37	Flat junction for specific size - tap off to an 105 mm wide branch with 65 mm cover	400	5/25
Partion junction			
0106 11	For internal angles	232	5/50
0106 32	For external angles	348	5/50
0107 42	For flat angles	828	5/25
Accessories			
Holding cables in place			
0106 86	Clip for 130 mm width cover	92	50
0106 82	Clip for 65 mm width cover	52	50
VDI accessories			
0107 80	For internal angles	576	5/50
0107 81	For external angles	618	5/50
0107 82	For flat angles	658	5/50
0107 83	For flat junctions	794	5/50
Mounting wiring accessories			
Accessories			
Additional accessories			
0106 98	Wall crossing for trunking 80 to 150 mm width	660	5/25
0308 81	Cable tie base	24	100/1000
0111 88	Earthing link	252	20/500
Capacity change Allows to increase 15mm height of trunking to preserve the space of wiring with a flat junction or a support equipment			
0106 87	Raise, length 57cm	240	40
0106 88	Set of 4 accessories to change capacity of the body	300	10/100
0106 89	Set of 2 accessories of change height of partition (to be used)	302	5/50

*LP - List Price Inclusive of excise duty but exclusive of sales tax or any other taxes.

(1) Price in Meters; No of meters in Pack, Standard length 2 meters to be ordered in multiples of 2 meters

DLP U-PVC adaptable trunking 150 x 50 mounting wiring accessories

Cat.Nos	Description	LP* ₹ / Unit	Pack
Supports for mounting wiring accessories			
Arteor™ supports Clip-on supports which can be fitted side by side Supplied with finishing plate			
0109 10	1 modules-for 40 mm cover	138	5/50
0109 21	2 modules-for 65 mm cover	130	20
0109 22	2 modules-for 85 mm cover	136	20
0109 31	3 modules-for 65 mm cover	184	5/50
0109 32	3 modules-for 85 mm cover	192	5/50
0109 41	4 modules-for 65 mm cover	196	10/50
0109 42	4 modules-for 85 mm cover	196	20
0109 61	6 modules-for 65 mm cover	232	5/25
0109 62	6 modules-for 85 mm cover	264	10
0109 27	Insulation unit for 2 modules (Arteor™) can be fitted together to create 4/6 module supports	234	10/100
0109 37	Insulation unit for 3 modules (Arteor™) supports	276	5/50
Legrand Lexic supports			
0109 25	For 2 modules for 65 mm cover (2 comp.)	810	5
0109 65	For 6 modules for 130 mm cover (1 comp.)	1080	5
0109 00	Hypra socket support - for 130 mm cover	1564	5
DLP U-PVC adaptable trunking system and accessories 195 x 50 Trunking and fittings			
Trunking			
Bodies Supplied without cover			
0104 52	195 x 50 mm	1524	8 ⁽¹⁾
Flexible cover Fits onto the whole branch including in internal or external angles			
0105 26	Full cover width 180 mm	816	8 ⁽¹⁾
0105 22	Full cover width 85 mm	304	20 ⁽¹⁾
0105 24	Full cover width 130 mm	642	8 ⁽¹⁾
0105 21	Full cover width 65 mm	268	24 ⁽¹⁾
0105 20	Full cover width 40 mm	270	20 ⁽¹⁾
Partitions			
0105 82	Separation partition for 195 x 50 trunking	180	24 ⁽¹⁾
0104 72	Plastic clip-on partition	266	48 ⁽¹⁾
0111 06	Aluminium clip-on partition	1032	12 ⁽¹⁾
Joints			
0106 91	Body joint - For aligning bases during installation	60	20/200
0108 06	Cover joint for 180 mm width	252	10/100
0108 02	Cover joint for 85 mm width	164	10/100
0108 04	Cover joint for 130 mm width	272	10/100
0108 01	Cover joint for 65 mm width	108	10/100
0108 00	Cover joint for 40 mm width	124	10/100
Angles and end caps			
Internal and external angles Include the 2 components for the top and bottom of the trunking on which the flexible cover is fitted			
0106 02	Internal angle, adjustable from 80° to 100°	378	10/40
0106 22	External angle, adjustable from 60° to 120°	380	10/50
Flat angle			
0107 92	90(0) flat angle	2290	2
End cap			
0107 07	Left or right end cap	320	5/50

Bold Cat.Nos are products normally available with Legrand (India) Stockists. Cat.Nos that are not bold - delivery within 4 - 8 weeks from the date of order. Bold packing quantity is our mandatory packing. Orders to be placed by Legrand (India) Stockiest in multiples of the same.

DLP U-PVC adaptable trunking system and accessories 195 x 50 trunking and fittings

Cat.Nos	Description	LP* ₹ / Unit	Pack
Junctions			
0107 32	Flat junction to tap-off a branch smaller than 50x105 To tap-off a branch of 150 x 50, use 2 nos of 0107 32 (2 x 0107 32)	692	10
0107 35	To tap-off to an 80 mm wide branch	404	5/25
0107 36	To a tap-off to a 105 mm wide branch equipped with a 85 mm cover	398	5/25
0107 37	Flat junction for specific size - tap off to an 105 mm wide branch with 65 mm cover	400	5/25
Partion junction			
0106 11	For internal angles	232	5/50
0106 32	For external angles	348	5/50
0107 42	For flat angles	828	5/25
Accessories			
Holding cables in place			
0106 86	Clip for 130 mm width cover	92	50
0106 82	Clip for 40 mm width cover	52	50
VDI accessories			
0107 80	For internal angles	576	5/50
0107 81	For external angles	618	5/50
0107 82	For flat angles	658	5/50
0107 83	For flat junctions	794	5/50
Additional accessories			
0106 99	Wall crossing for trunking 195 mm width	690	5/25
0308 81	Cable tie base	24	100/1000
0111 88	Earthing link	252	20/500
Capacity Change			
Allows to increase 15mm height of trunking to preserve the space of wiring with a flat junction or a support equipment			
0106 87	Raise, length 57 cm	240	40
0106 88	Set of 4 accessories to change capacity of the body	300	10/100
0106 89	Set of 2 accessories of change height of partition (to be used)	302	5/50
Supports for mounting wiring accessories			
Arteor™ supports			
Clip-on supports which can be fitted side by side Supplied with finishing plate			
0109 10	1 modules-for 40 mm cover	138	5/50
0109 21	2 modules-for 65 mm cover	130	20
0109 22	2 modules-for 85 mm cover	136	20
0109 31	3 modules-for 65 mm cover	184	5/50
0109 32	3 modules-for 85 mm cover	192	5/50
0109 41	4 modules-for 65 mm cover	196	10/50
0109 42	4 modules-for 85 mm cover	196	20
0109 61	6 modules-for 65 mm cover	232	5/25
0109 62	6 modules-for 85 mm cover	264	10
Mounting wiring accessories			
Supports for mounting wiring accessories			
Legrand Lexic supports			
0109 25	For 2 modules for 65 mm cover (3 comp.)	810	5
0109 35	For 3 modules for 85 mm cover (2 comp.)	962	5
0109 27	Insulation unit for 2 modules (Arteor™) can be fitted together to create 4/6 module supports	234	10/100
0109 37	Insulation unit for 3 modules (Arteor™) supports	276	5/50

*LP - List Price Inclusive of excise duty but exclusive of sales tax or any other taxes.

(1) Price in Meters; No of meters in Pack, Standard length 2 meters to be ordered in multiples of 2 meters

Red Cat.Nos - new products

DLP aluminium adaptable trunking system 50 x 105

Cat.Nos	Description	LP* ₹ / Unit	Pack
Body			
0111 00	Supplied without cover	3354	8 ⁽¹⁾
Cover and partition			
0111 11	Full rigid cover 85 mm width	1096	16 ⁽¹⁾
0111 08	Separation partition	574	24 ⁽¹⁾
Finishing accessories			
0111 58	End cap	588	20/100
0112 43	Flat angle for 85mm cover	5084	10
0112 32	External angle for 85mm cover	6342	1
0112 21	Internal angle for 85mm cover	5708	1
0112 51	Flat junction To tap off to 105 mm wide trunking equipped with 85 mm cover	6906	5
0111 66	Body joint	194	20/100
0111 63	Cover joint	288	10/100
Supports for Arteor™ for cover 85 mm width			
0112 12	2 modules	412	20
0112 13	3 modules	486	20
0112 14	4 modules	488	20
0112 16	6 modules	648	10
Cabling accessories			
0106 82	Clip	52	50
0111 88	Earth link	252	20
0308 81	Base for cable ties	24	100
DLP aluminium adaptable trunking system 50 x 150			
Body			
0111 02	Supplied without cover Allow fitting of partial covers - 2 compartments	4224	4 ⁽¹⁾
Covers and partitions			
0111 10	Partial rigid cover 65 mm width	832	16 ⁽¹⁾
0111 12	Full rigid cover 130 width	1508	8 ⁽¹⁾
0111 06	Division partition for cover 65 mm width	1032	12 ⁽¹⁾
0111 08	Separation partition	574	24 ⁽¹⁾
Finishing accessories			
0111 60	End cap	1266	10
0112 45	Flat angle for cover 65/130mm	8566	5
0112 34	External angle cover 130mm	9428	1
0112 38	External angle 2 cover 65 mm	13500	1
0112 23	Internal angle Cover 130mm	7508	1
0112 27	Internal angle 2 Covers 65 mm	13400	1
0112 51	Flat junction To tap off to 105 mm wide trunking equipped with 85 mm cover	6906	5
0111 66	Body joint	194	20
0111 62	Cover joint for cover 65 mm	272	10
0111 64	Cover joint for cover 30 mm	594	10
Supports for Arteor™ for cover 65 mm width			
0112 02	2 modules	378	20
0112 03	3 modules	458	20
0112 04	4 modules	476	20
0112 06	6 modules	562	10
Cabling accessories			
0106 82	Clip for 65 mm cover	52	50
0106 86	Clip for 130 mm cover	92	50
0111 88	Earth link	252	20
0308 81	Base for cable ties	24	100

Bold Cat.Nos are products normally available with Legrand (India) Stockists. Cat.Nos that are not bold - delivery within 4 - 8 weeks from the date of order. Bold packing quantity is our mandatory packing. Orders to be placed by Legrand (India) Stockiest in multiples of the same.

DLP aluminium adaptable trunking system 50 x 195

Cat.Nos	Description	LP* ₹ / Unit	Pack
Body			
0111 04	Supplied without cover allow fitting of partial covers - 1 compartment	4950	4 ⁽¹⁾
Covers and partitions			
0111 11	Partial rigid cover 85 mm width	1096	16 ⁽¹⁾
0111 13	Full rigid cover 180 width	2232	8 ⁽¹⁾
0111 08	Separation partition	574	24 ⁽¹⁾
0111 06	Division partition for cover 85 mm width	1032	12 ⁽¹⁾
Finishing accessories			
0111 61	End cap	1496	10
0112 47	Flat angle for cover 85/180mm	8828	2
0112 36	External angle for 180 mm Cover	10272	1
0112 40	External angle 2 covers 85mm	14100	1
0112 25	Internal angle Cover 180mm	8872	1
0112 29	Internal angle 2 Cover 85mm	14000	1
0112 51	Flat junction To tap off to 105 mm wide trunking equipped with 85 mm cover	6906	5
0111 66	Body joint	194	20
0111 63	Cover joint for cover 85 mm	288	10
0111 65	Cover joint for cover 180 mm	636	10
Supports for Arteor™ for cover 85 mm width			
0112 12	2 modules	412	20
0112 13	3 modules	486	20
0112 14	4 modules	488	20
0112 16	6 modules	648	10
Cabling accessories			
0106 82	Clip for 85 mm cover	52	50
0106 86	Clip for 180 mm cover	92	50
0111 88	Earth link	252	20
0308 81	Base for cable ties	24	100
Aluminium snap-on columns			
Columns			
74 x 80 mm - 1 compartment			
6038 00	Height 2.70 m Can be adapted to a ceiling height up to 3.70 m	21734	1
6038 02	Height 3.70 m Can be adapted to a ceiling height up to 4.70 m	25376	1
81 x 130 mm - 2 compartments			
6038 01	Height 2.70 m Can be adapted to a ceiling height up to 3.70 m	30110	1
6038 03	Height 3.70 m Can be adapted to a ceiling height up to 4.70 m	35474	1
Separation partition for 74 x 80 and 81 x 130 snap-on columns			
6038 07	Height 60 mm	396	36 ⁽¹⁾
Mini-column			
6038 05	81x130mm-2 compartments Height 0.68 m Can be associated with floor trunking range	12484	1
Other accessories			
0111 88	Accessory - Earth Link	252	20
6038 57	Fixing CLIP- Normaclip	188	10
6038 58	Fixing CLIP- Normaclip	524	10

*LP - List Price Inclusive of excise duty but exclusive of sales tax or any other taxes.

(1) Price in Meters; No of meters in Pack, Standard length 2 meters to be ordered in multiples of 2 meters

Red Cat.Nos - new products

LCS² ZONE DISTRIBUTION BOXES

Consolidation and redistribution made easy

Complete flexibility with the LCS² zone boxes: centralisation of connections close to the workstation, copper and fibre optics can be used together.



- Flexible installation with lines in reserve meet future requirements quickly.
- Guaranteed performance across the whole LCS² system.
- Fast, reliable connection to the LCS² zone box with sockets with copper and fibre optic feedthrough and RJ 45/RJ 45 cords.

Available in cat. 6A

NEW!



Bold Cat.Nos are products normally available with Legrand (India) Stockists. Cat.Nos that are not bold - delivery within 4 - 8 weeks from the date of order. Bold packing quantity is our mandatory packing. Orders to be placed by Legrand (India) Stockiest in multiples of the same.

AUDIO/VIDEO PRETERMINATED SOCKETS

The right system to meet your needs

A wide range of technologies (HD15, HDMI, DISPLAY PORT, RCA, JACK)
to suit the location and the user requirements

INSTALLATION EXAMPLE WITH HD15 PRETERMINATED SOCKET AND VIDEO PROJECTOR SWITCH

1 Quick
installation

2 Easy
connection

3 Optimum
performance



1 Infrared ON/STANDBY control
for video projector associated
with a pushbutton
Cat.No 0 787 99/5 720 89

2 3 Preterminated HD15 sockets
Cat.No 0 787 77/5 720 97

4 10 m male/male HD15 cords
Cat.No 0 517 23

5 6 Male/male HD 15 cords



Click to discover us

- 1** Legrand (India) - provides all information regarding the groups philosophy, products, organisation etc.
- 2** Products and solutions - complete information about our range of products for residential, commercial and industrial markets.
- 3** Downloads - download catalogues and brochures.

snap-on trunking routing sections and accessories

TRUNKING			TRUNKING		
Number of compartments	Cover width	Cross-section (mm)	Monobloc: body + cover ⁽¹⁾	Divider	Fishplate body joint
SNAP-ON TRUNKING - 45 mm cover					
	45	50 x 80	○ 0756 01	0756 09	0756 61
	45	50 x 105	0756 02	0756 09	0756 62
	45 45	50 x 130	○ 0756 03	-	0756 61
	45 45	50 x 145	0756 04	-	0756 63
	45 45 45	50 x 180	0756 06	-	0756 61

1: Partition(s) integral to the body
2: Internal and external corner angles supplied with multi-compartment partition joint

mechanisms for snap-on trunking

Mounting functions

The Arteor sockets to be fitted with Soluclip accessory which has following features:

- Anti-slip
- Anti-pullout
- IP 4X
- Perfect finish



0756 90

AND ACCESSORIES			ANGLES			JUNCTIONS				ACCESSORIES	
Stick-on body joint	Cover joint	End cap	Internal angles ⁽²⁾	External angles	Flat angles	Flat junctions with width 80 mm	Flat junctions with width 105 mm	Angled junctions 85/105/130 mm	Junction with floor duct 50 x 12/ 92 x 20	Extra cover	Adaptor for modular wiring accessories
0756 66	0756 69	0756 11	0756 21	0756 31	0756 41	0756 71	-	0756 81 + 0756 21	0756 88	0756 08	0310 69
0756 67	0756 69	0756 12	0756 22	0756 32	0756 42	0756 72	0756 76	0756 81 + 0756 22	0756 88	0756 08	0310 69
0756 66	2 x 0756 69	0756 13	0756 23	0756 33	0756 43	0756 71	0756 75	0756 81 + 0756 23	0756 88	0756 08	0310 69
① 0756 66 + ② 0756 67	2 x 0756 69	0756 14	0756 24	0756 34	0756 44	① 0756 71 + ② 0756 72	① 0756 75 + ② 0756 76	0756 81 + 0756 24	0756 88	0756 08	0310 69
0756 66	3 x 0756 69	0756 16	0756 26	0756 36	0756 36	0756 71	0756 75	0756 81 + 0756 26	0756 88	0756 08	0310 69

Installation principle for sockets for snap-on trunking



























1	2	3	4	5	6
Snap the sockets directly into the trunking	Install the covers	Disengage the finishing piece	Rotate the finishing piece by 180°	Snap on the finishing piece	An impeccable result

Installation principle for Arteor functions







1	2	3	4	5	6
Snap on the mechanism and fix with Soluclips	Install the covers	Disengage the finishing piece	Rotate the finishing piece by 180°	Snap on the finishing piece	An impeccable result

DLP U-PVC adaptable trunking systems for installations base, covers, partitions, finishing accessories and mounting wiring accessories

Selection chart for Installation of trunking, Accessories and Arteor™

Trunking			Covers		Clip on partition		Arteor™ frames				
Number of compartments	Cover(s) width	Section (mm)									
			Flexible	Partitions separation	Plastic	Aluminium	1 module	2 module	3 module	4 module	6 module
 0104 12	1 1 x 65 	80 x 50	0105 21	0105 82	-	-	-	0109 21	0109 31	0109 41	0109 61
 0104 22	1 1 x 85 	105 x 50	0105 22	0105 82	-	-	-	0109 22	0109 32	0109 42	0109 62
	2 2 x 40 		0105 20	0105 82	0104 72	0111 06	0109 10	-	-	-	-
 0104 32	1 1 x 130 	150 x 50	0105 24	0105 82	-	-	-	-	-	-	-
	2 2 x 65 		0105 21	0105 82	0104 72	0111 06	-	0109 21	0109 31	0109 41	0109 61
	2 1 x 40 + 1 x 85 		0105 20 + 0105 22	0105 82	0104 72	0111 06	0109 10	0109 22	0109 32	0109 42	0109 62
	3 3 x 40 		0105 20	0105 82	0104 72 x 2	0111 06 x 2	0109 10	-	-	-	-
 0104 52	1 1 x 180 	195 x 50	0105 26	0105 82	-	-	-	-	-	-	-
	2 2 x 85 		0105 22	0105 82	0104 72	0111 06	-	0109 22	0109 32	0109 42	0109 62
	2 1 x 40 + 1 x 130 		0105 20 + 0105 24	0105 82	0104 72	0111 06	0109 10	-	-	-	-
	3 1 x 85 + 2 x 40 		0105 22 + 0105 20	0105 82	0104 72 x 2	0111 06 x 2	0109 10	0109 22	0109 32	0109 42	0109 62
	3 1 x 40 + 2 x 65 		0105 20 + 0105 21	0105 82	0104 72 x 2	0111 06 x 2	0109 10	0109 21	0109 31	0109 41	0109 61
	4 4 x 40 		0105 20	0105 82	0104 72 x 3	0111 06 x 3	0109 10	-	-	-	-

Selection chart for Installation trunking, Accessories and Arteor™

Section (mm)	 Wall crossing	 Capacity change	 Partition junction	 Cable tie base	Insulating unit for Arteor™ modules		Earth Link
					 2 Module Combined to get 4/6 Module	 3 Module	
80 x 50 / 105 x 50	0106 98	0106 87 + 0106 88 + 0106 89 (to be used for partition)	0106 89	0308 81	0109 27	0109 37	0111 88
150 x 50 / 195 x 50	0106 99						

Selection chart for Installation of trunking, Additional accessories

Cover	Bases		Internal angles 80° - 100°			External angles 60° - 120°			Flat angles		Flat junction			
Joint for covers	Base joint	End caps	Angles	Partition junction	VDI access.	Angles	Partition junction	VDI access.	Angles	VDI access.	Angles	Partition junction	VDI access.	Clips
0108 01	0106 91	0107 22	0106 02	-	0107 80	0106 22	-	0107 81	0107 67	0107 82	0107 32	-	0107 83	0106 82
0108 02	0106 91	0107 02	0106 02	-	0107 80	0106 22	-	0107 81	0107 85	0107 82	0107 32	-	0107 83	0106 82
0108 00	0106 91	0107 02	0106 02	0106 11	-	0106 22	0106 32	-	-	-	0107 32	0107 42	-	0106 82
0108 04	0106 91	0107 06	0106 02	-	-	0106 22	-	-	0107 89	-	0107 32	-	-	0106 86
0108 01	0106 91	0107 06	0106 02	0106 11	0107 80	0106 22	0106 32	0107 81	0107 89	0107 82	0107 32	0107 42	0107 83	0106 82
0108 02	0106 91	0107 06	0106 02	0106 11	0107 80	0106 22	0106 32	0107 81	0107 89	0107 82	0107 32	0107 42	0107 83	0106 82
0108 00	0106 91	0107 06	0106 02	0106 11 x 2	-	0106 22	0106 32 x 2	-	0107 89	-	0107 32	0107 42	-	0106 82
0108 06	0106 91	0107 07	0106 02	-	-	0106 22	-	-	0107 92	-	0107 32	-	-	0106 86
0108 02	0106 91	0107 07	0106 02	0106 11	0107 80	0106 22	0106 32	0107 81	0107 92	0107 82	0107 32	0107 42	0107 83	0106 82
	0106 91	0107 07	0106 02	0106 11	0107 80	0106 22	0106 32	0107 81	0107 92	0107 82	0107 32	0107 42	0107 83	
	0106 91	0107 07	0106 02	0106 11 x 2	0107 80	0106 22	0106 32 x 2	0107 81	0107 92	0107 82	0107 32	0107 42	0107 83	0106 82
	0106 91	0107 07	0106 02	0106 11 x 2	0107 80	0106 22	0106 32 x 2	0107 81	0107 92	0107 82	0107 32	0107 42	0107 83	0106 82
0108 00	0106 91	0107 07	0106 02	0106 11 x 3	-	0106 22	0106 32 x 3	-	0107 92	-	0107 32	0107 42	-	0106 82

DLP mini trunking systems for cable distribution









■ Selection chart for DLP mini trunking

	Length	Finishing Accessories				Junction Elements
WHITE	2 m	End cap	Internal angle	External angle	Flat angle	Flat junction
32 x 12.5	0300 15	0312 03	0302 51	0302 51	0302 53	0302 54
32 x 16	0308 04	0312 07	0333 25	0333 25	0333 27	0333 30
32 x 20	0300 17	0312 09	0302 71	0302 71	0302 73	0302 74





DLP aluminium trunking system

selection chart of sections, covers and accessories
selection chart of support for wiring accessories

TRUNKING AND ACCESSORIES

				Rigid covers 					Trunking 	
Width (mm)	Nos. of compartments	Covers width	Cat. nos.	65 mm width	85 mm width	130 mm width	180 mm width	Cover Joint	Base Joint	
105 x 50	1 	1 x 85	111 00	-	0111 11	-	-	0111 63	0111 66	
150 x 50	1 	1 x 130	0111 02	2 x 0111 10	-	0111 12	-	0111 64	0111 66	
	2 	2 x 65						0111 62		
195 x 50	1 	1 x 180	0111 04	-	2 x 0111 11	-	0111 13	0111 65	0111 66	
	2 	2 x 85						0111 63		

SUPPORT FOR WIRING ACCESSORIES

60 mm fixing centers : Arteur™	Cover depths	
No of module	65 mm	85 mm
2 modules 	0112 02	0112 12
3 modules 	0112 03	0112 13
4 modules 	0112 04	0112 14
6 modules 	0112 06	0112 16

Insulation resistance : the entire DLP range, including accessories, have insulation resistance above 5 Megaohms

DLP TRUNKING SYSTEM ALUMINIUM

with aluminium adaptable
DLP trunking,
get better styling too !



SELECTION CHART OF ACCESSORIES (continued)

Dividers		End cap	Internal angles	External angles	Flat angles	Junction Flat junction*	Clips	Earth link
Clip-on partition	Separation partition							
-	0111 08	0111 58	0112 21	0112 32	0112 43	011 251	0106 82	0111 88
0111 06	0111 08	0111 60	0112 23	0112 34	0112 45	011 251	0106 86	0111 88
	0111 08		0112 27	0112 38			0106 81	
0111 06	0111 08	0111 61	0112 25	0112 36	0112 47	011 251	0106 86	0111 88
	0111 08		0112 29	0112 40			0106 82	

(1) To be used with angle covers. (2) To be used with rigid covers

TABLE OF CAPACITIES

	Crosssection (mm ²) Max. Ø (mm ²)	105 x 50	150 x 50			195 x 50		
		cover 85	cover 65	cover 65	cover 130	cover 85	cover 85	cover 180
Trunking only	Cross-section	4330	3020	3020	6470	5350	5350	111 60
	Max. Ø	28	43	2 x 43	28	55	55	3 x 54
With Arteor™ / support	Cross-section	2300	1470	1470	-	3320	3320	-
	Max. Ø	2 x 24	18	18	-	33	33	-

*To tap off 105 mm wide trunking with 85 mm cover



SAVE TIME

- Flexibility : multi-covers
- Removable separation
- Angles delivered pre-cut, ready to use
- Fast fixing device support
- Uniform colours for the entire installation
- Arteor™ wiring accessories go with aluminium adaptable DLP trunking

Copper



The new LCS² RJ 45 connector is the core element contributing to the performance of the LCS² system, which obtains a perfect connection within a few seconds.

Fibre Optic



The new LCS² Fibre optic drawer gives a better comfort in installation and maintenance.

Enclosures & Cabinets



The new LCS² enclosures facilitates managing the cables and cords



The design of the new LCS² patch panels optimises the mounting and maintenance.



Legrand solutions, including the rapid crimping connection process and pre-fitted fibre optic links on demand have made a significant contribution to placing fibre optics within the reach of installers.



The new LCS² wall-mounting cabinets can be fitted anywhere where maintaining aesthetic quality is very important.

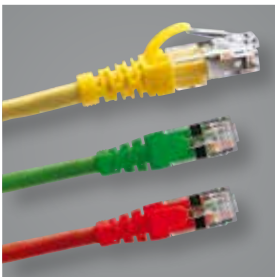

Ensure total coherence of LCS² cat. 6A, cat. 6 and cat. 5e systems.



Complete accessibility not only via the doors and panels, but also thanks to the high pre-cuts and low opening.

Workstations



With the new LCS² zone distribution boxes connected to the Arteor™ feed through sockets, the result is complete flexibility.



Network within reach. On the wall with trunking, on the ceiling with columns, on the ground with floor boxes and desktop multi-outlet extensions or nearby with blocks and mini-columns. They are suitable for all work space configurations.



In the technical room, in a false ceiling or in the floor boxes and desktop multi-outlet extensions, it is necessary to identify the special networks at a single glance. The Arteor™ LCS² sockets has coloured covers.



Wi-Fi access points can be fitted anywhere where unrestricted access to the computer network is required.

LCS²

From technical room to workstation

Complete systems with a 20-year guarantee. The new LCS² cat. 6A (up to 500 mHz), cat. 6 (up to 250 mHz) and cat. 5e (up to 100 mHz) systems have been designed as coherent entities to optimise their performance. The systems are suitable for optical fibre cables as well as copper cables.

The new LCS² systems integrate perfectly in the various other Legrand solutions: DLP trunking system, cabling accessories, cable management, etc.



Cabling system LCS² category 6A

Cat.Nos	Description	MRP* ₹ / Unit	Pack
---------	-------------	------------------	------

Patch panel cat. 6A 24 x RJ 45 connectors

0335 73	STP - metal shielding 360°	■	1/3
----------------	----------------------------	---	-----

Modular panel

0335 90	19" panel - 1 U	■	1/3
----------------	-----------------	---	-----

Units of 6 x RJ 45 connectors cat. 6A

0335 76	STP unit - metal shielding 360°	■	2/24
0335 91	Blanking plate for 19" panel - black	■	10/100

Cables

Cables for local networks cat. 6A

0327 78	F/UTP - 4 pairs length 500 m	■	500 ⁽¹⁾
0328 78	F/UTP - 2x4 pairs length 500 m	■	500 ⁽¹⁾
0327 77	S/FTP - 4 pairs length 500 m	■	500 ⁽¹⁾

Cords

RJ 45 patch cords and user cords cat. 6A

S/FTP shielded impedance 100 Ω

PVC - Yellow sheath

0517 80	Length 1 m	■	5/50
0517 81	Length 2 m	■	5/50
0517 82	Length 3 m	■	5/50
0517 83	Length 5 m	■	5

LSZH - Red sheath

0518 70	Length 1 m	■	1/10
0518 71	Length 2 m	■	1/10
0518 72	Length 3 m	■	1/10
0518 73	Length 5 m	■	1/5

LSZH - Green sheath

0518 66	Length 1 m	■	1/10
0518 67	Length 2 m	■	1/10
0518 68	Length 3 m	■	1/10
0518 69	Length 5 m	■	1/5

Zone distribution boxes

Self-assembly zone distribution box

0335 40	Used for mounting LCS ² RJ 45 connector blocks cat. 6A, cat. 6 and cat. 5e, of fibre optic accessories or blanking plates	■	1/10
----------------	--	---	------

RJ 45 sockets

Arteor™ RJ 45 socket cat. 6A

5734 32	STP - white - 1 module	■	20/200
5728 06	STP-magnesium - 1 module	■	10/100
5723 52	STP - white with green shutter - 1 module	■	10/100
5728 52	STP - magnesium with green shutter - 1 module	■	10/100
5723 51	White with orange shutter	■	10/100
5728 51	Magnesium with orange shutter	■	10/100

STP with controlled access - 2 modules

5723 50	White with red shutter	■	5/50
5728 50	Magnesium with red shutter	■	5/50

* MRP - Maximum Retail Price Inclusive of all taxes.

■ Price available on request.

(1) in meters

Cabling system LCS² category 6

Cat.Nos	Description	MRP* ₹ / Unit	Pack
---------	-------------	------------------	------

Patch panels cat. 6 24 x RJ 45 connectors

0335 61	UTP panel - 8 contacts	■	1/3
0335 62	FTP panel - 9 contacts	■	1/3
0335 63	STP panel - metal shielding 360°	■	1/3
0335 89	UTP through panel 24 x RJ 45 connectors	■	1/10

Modular panels

0335 90	19" panel - 1 U	■	1/3
----------------	-----------------	---	-----

Units of 6 x RJ 45 connectors cat. 6

0335 64	UTP unit - 8 contacts	■	2/24
0335 65	FTP unit - 9 contacts	■	2/24
0335 66	STP unit - metal shielding 360°	■	2/24
0335 91	Blanking plate for 19" panel - black	■	10/100

Cables

Cables for local networks cat. 6

U/UTP - 4 pairs

LSZH - Blue sheath

0327 54	Length 305 m	■	305 ⁽¹⁾
0328 61	Length 500 m	■	500 ⁽¹⁾
0328 71	Length 1000 m	■	1000 ⁽¹⁾

PVC - Blue sheath

0327 55	Length 305 m	■	305 ⁽¹⁾
0328 62	Length 500 m	■	500 ⁽¹⁾
0328 72	Length 1000 m	■	1000 ⁽¹⁾

U/UTP - 2 x 4 pairs

0328 63	Length 500 m	■	500 ⁽¹⁾
----------------	--------------	---	--------------------

F/UTP - 4 pairs

LSZH - Blue sheath

0328 56	Length 305 m	■	305 ⁽¹⁾
0327 56	Length 500 m	■	500 ⁽¹⁾

PVC - Blue sheath

0328 57	Length 305 m	■	305 ⁽¹⁾
0327 58	Length 500 m	■	500 ⁽¹⁾

F/UTP - 2 x 4 pairs

LSZH - Blue sheath

0327 76	Length 500 m	■	500 ⁽¹⁾
----------------	--------------	---	--------------------

PVC - Blue sheath

0328 58	Length 500 m	■	500 ⁽¹⁾
----------------	--------------	---	--------------------

SF/UTP - 4 pairs

LSZH - Blue sheath

0327 57	Length 500 m	■	500 ⁽¹⁾
----------------	--------------	---	--------------------

PVC - Blue sheath

0327 59	Length 500 m	■	500 ⁽¹⁾
----------------	--------------	---	--------------------

SF/UTP - 2 x 4 pairs

0328 59	Length 500 m	■	500 ⁽¹⁾
----------------	--------------	---	--------------------

Bold Cat.Nos are products normally available with Legrand (India) Stockists. Cat.Nos that are not bold - delivery within 4 - 8 weeks from the date of order. Bold packing quantity is our mandatory packing. Orders to be placed by Legrand (India) Stockiest in multiples of the same.

Cabling system LCS² category 6

Cat.Nos	Description	MRP* ₹ / Unit	Pack
---------	-------------	------------------	------

Cords

RJ 45 patch cords and user cords cat. 6

RJ 45 - RJ 45 right

U/UTP unscreened impedance 100Ω

PVC - Blue sheath

0517 72	Length 1 m	■	1/20
0517 73	Length 2 m	■	1/20
0517 74	Length 3 m	■	1/20
0517 75	Length 5 m	■	1/20

LSZH - Red sheath

0518 62	Length 1 m	■	1/20
0518 63	Length 2 m	■	1/20
0518 64	Length 3 m	■	1/20
0518 65	Length 5 m	■	1/20

LSZH - Green sheath

0518 58	Length 1 m	■	1/20
0518 59	Length 2 m	■	1/20
0518 60	Length 3 m	■	1/20
0518 61	Length 5 m	■	1/20

F/UTP screened impedance 100Ω

PVC - Blue sheath

0517 62	Length 1 m	■	1/20
0517 63	Length 2 m	■	1/20
0517 64	Length 3 m	■	1/20
0517 65	Length 5 m	■	1/20

LSZH - Red sheath

0518 54	Length 1 m	■	1/20
0518 55	Length 2 m	■	1/20
0518 56	Length 3 m	■	1/20
0518 57	Length 5 m	■	1/20

LSZH - Green sheath

0518 50	Length 1 m	■	1/20
0518 51	Length 2 m	■	1/20
0518 52	Length 3 m	■	1/20
0518 53	Length 5 m	■	1/20

SF/UTP shielded impedance 100Ω

PVC - Blue sheath

0517 52	Length 1 m	■	5/50
0517 53	Length 2 m	■	5/50
0517 54	Length 3 m	■	5/50
0517 55	Length 5 m	■	5

Zone distribution boxes

0335 44	Cat. 6 – UTP	■	1/10
0335 45	Cat. 6 – FTP	■	1/10
0335 46	Cat. 6 – STP	■	1/10

Self-assembly zone distribution box

0335 40	Used for mounting LCS ² RJ 45 connector blocks	■	1/10
---------	--	---	------

Cords cat. 6 - RJ 45/stripped AWG 24

U/UTP unscreened impedance 100Ω

0517 57	Length 8 m	■	4
0517 58	Length 15 m	■	4
0517 59	Length 20 m	■	4

Cabling system LCS² category 6

Cat.Nos	Description	MRP* ₹ / Unit	Pack
---------	-------------	------------------	------

Cords cat. 6 - RJ 45/stripped AWG 24

F/UTP screened impedance 100Ω

0517 96	Length 8 m	■	4
0517 97	Length 15 m	■	4
0517 98	Length 20 m	■	4

Cords cat. 6 - RJ 45/RJ 45

U/UTP unscreened impedance 100Ω

0515 10	Length 8 m	■	4
0515 11	Length 15 m	■	4
0515 12	Length 20 m	■	4

F/UTP screened impedance 100Ω

0515 13	Length 8 m	■	4
0515 14	Length 15 m	■	4
0515 15	Length 20 m	■	4

Sockets with copper feedthrough cat. 6

5723 31	Cat. 6 UTP Arteor™ white	■	10/100
5728 31	Cat. 6 UTP Arteor™ magnesium	■	10/100
5723 33	Cat. 6 FTP Arteor™ white	■	10/100
5728 33	Cat. 6 FTP Arteor™ magnesium	■	10/100

RJ 45 sockets

Arteor™ RJ 45 socket cat. 6

5734 28*	UTP - white 1 module	–	20/200
5736 28**	UTP - magnesium 1 module	–	20/200
5734 74*	UTP - white 2 modules	–	10/100
5736 74**	UTP - magnesium 2 modules	–	10/100
5723 24	UTP - white – 2 modules – round	■	10/100
5728 24	UTP - magnesium 2 modules – round	■	10/100
5723 53	UTP with controlled access white with red shutter - 2 modules	■	5/50
5728 53	UTP with controlled access- magnesium with red shutter	■	5/50
5723 39	UTP retractable RJ 45 - white - 4 modules	■	1/20
5728 39	UTP retractable RJ 45 - sockets magnesium - 4 modules	■	1/20
5723 22	FTP - white - 1 module	■	10/100
5728 22	FTP -magnesium - 1 module	■	10/100
5723 54	FTP - white with orange shutter 1 module	■	10/100
5728 54	FTP - magnesium with orange shutter 1 module	■	10/100
5723 55	FTP - white with green shutter 1 module	■	10/100



5723 31



5736 28

Bold Cat.Nos are products normally available with Legrand (India) Stockists. Cat.Nos that are not bold - delivery within 4 - 8 weeks from the date of order. Bold packing quantity is our mandatory packing. Orders to be placed by Legrand (India) Stockiest in multiples of the same.

* MRP - Maximum Retail Price Inclusive of all taxes.

■ Price available on request.

* Refer page no 76

** Refer page no 79

Cabling system LCS² category 5e

Cat.Nos	Description	MRP* ₹ / Unit	Pack
---------	-------------	------------------	------

RJ 45 sockets

Arteor™ RJ 45 socket cat. 6

5728 55	FTP - magnesium with green shutter 1 module	■	10/100
5734 76	FTP - white 2 module	■	10/100
5736 76	FTP - magnesium 2 module	■	10/100
5734 34	Shielded STP white - 1 module	■	20/200
5736 34	Shielded STP magnesium - 1 module	■	20/200
5734 77	Shielded STP white - 1 module	■	10/100
5736 77	Shielded STP magnesium 1 module	■	10/100



5736 76

Patch panels cat. 5e

24 x RJ 45 connectors

0335 51	UTP panel 8 contacts	■	1/3
0335 52	FTP panel 9 contacts	■	1/3
0335 88	UTP through panel 24 RJ 45 connectors	■	1/10



0335 52

Modular panels

0335 90	19" panel - 1 U	■	1/3
---------	-----------------	---	-----



0335 90

Units of 6 x RJ 45 connectors cat. 5e

0335 54	UTP unit	■	2/24
0335 55	FTP unit	■	2/24
0335 91	Blanking plate for 19" panel - black	■	10/100



0335 55

Cables for local networks cat. 5e

U/UTP - 4 pairs

LSZH - grey sheath

0327 50	Length 305 m	■	305 ⁽¹⁾
0328 53	Length 500 m	■	500 ⁽¹⁾
0328 73	Length 1000 m	■	1000 ⁽¹⁾

PVC - grey sheath

0327 51	Length 305 m	■	305 ⁽¹⁾
0328 54	Length 500 m	■	500 ⁽¹⁾
0328 74	Length 1000 m	■	1000 ⁽¹⁾

U/UTP - 2x4 pairs -

LSZH - grey sheath

0328 55	Length 500 m	■	500 ⁽¹⁾
---------	--------------	---	--------------------

PVC - grey sheath

0327 73	Length 500 m	■	500 ⁽¹⁾
---------	--------------	---	--------------------

F/UTP - 4 pairs -

LSZH - grey sheath

0327 52	Length 305 m	■	305 ⁽¹⁾
0328 50	Length 500 m	■	500 ⁽¹⁾

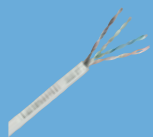

0328 50

* MRP - Maximum Retail Price Inclusive of all taxes.

■ Price available on request.

(1) in meters

Cabling system LCS² category 5e

Cat.Nos	Description	MRP* ₹ / Unit	Pack
---------	-------------	------------------	------

Cables for local networks cat. 5e

F/UTP - 4 pairs -

PVC - grey sheath

0327 53	Length 305 m	■	305 ⁽¹⁾
0328 51	Length 500 m	■	500 ⁽¹⁾

F/UTP - 2x4 pairs -

LSZH - grey sheath

0327 74	Length 500 m	■	500 ⁽¹⁾
---------	--------------	---	--------------------

PVC - grey sheath

0328 52	Length 500 m	■	500 ⁽¹⁾
---------	--------------	---	--------------------

Cords

RJ 45 patch cords and user cords cat. 5e

U/UTP unshielded impedance 100Ω

0516 36	Length 1 m - grey	■	1/20
0516 37	Length 2 m - grey	■	1/20
0516 38	Length 3 m - grey	■	1/20
0516 39	Length 5 m - grey	■	1/20

F/UTP screened impedance 100Ω

0516 40	Length 1 m - grey	■	1/20
0516 41	Length 2 m - grey	■	1/20
0516 42	Length 3 m - grey	■	1/20
0516 43	Length 5 m - grey	■	1/20



0516 40

Zone distribution boxes

Self-assembly zone distribution box

0335 40	Used for mounting LCS ² RJ 45 connector blocks	■	1/10
---------	---	---	------

Cords cat. 5e - RJ 45 / stripped

U/UTP unshielded impedance 100

0517 90	Length 8 m	■	4
0517 91	Length 15 m	■	4
0517 92	Length 20 m	■	4

F/UTP screened impedance 100Ω

0517 93	Length 8 m	■	4
0517 94	Length 15 m	■	4
0517 95	Length 20 m	■	4

Cords cat. 5e - RJ 45/RJ 45

U/UTP unshielded impedance 100Ω

0515 00	Length 8 m	■	4
0515 01	Length 15 m	■	4
0515 02	Length 20 m	■	4

F/UTP unshielded impedance 100Ω

0515 03	Length 8 m	■	4
0515 04	Length 15 m	■	4
0515 05	Length 20 m	■	4

Sockets with copper feedthrough cat. 5e

5723 30	Cat. 5e UTP - Arteor™ white	■	10/100
5728 30	Cat. 5e UTP - Arteor™ - magnesium	■	10/100
5723 32	Cat. 5e FTP - Arteor™ white	■	10/100
5728 32	Cat. 5e FTP - Arteor™ - magnesium	■	10/100

Bold Cat.Nos are products normally available with Legrand (India) Stockists. Cat.Nos that are not bold - delivery within 4 - 8 weeks from the date of order. Bold packing quantity is our mandatory packing. Orders to be placed by Legrand (India) Stockiest in multiples of the same.

Cabling system LCS² category 5e

Cat.Nos	Description	MRP* ₹ / Unit	Pack
---------	-------------	------------------	------

RJ 45 sockets

Arteor™ RJ 45 socket cat. 5e

5734 29 [▲]	UTP - white 1 module	–	20/200
5736 29 ^{**}	UTP - magnesium 1 module	–	20/200
5734 75 [▲]	UTP - white 2 modules	–	10/100
5736 75 ^{**}	UTP - magnesium 2 modules	–	10/100
5734 30	FTP - white 1 module	■	20/200
5736 30	FTP - magnesium 1 module	■	20/200



5734 75

Plexo RJ 45 sockets, cat. 5e

IP 55 closed flap IK 07

0695 57	FTP socket	■	1/20
0695 56	UTP socket	■	1/20
0695 81	Adapter for RJ 45 socket	■	1/10



0695 57

Cabling system LCS² category cat. 6A, LCS² cat. 6, LCS² cat. 5e

Modular panels

0335 90	19" panel - 1 U	■	1/3
---------	-----------------	---	-----

Doubler units

0335 54	UTP unit	■	2/24
0335 55	FTP unit	■	2/24
0335 91	Blanking plate for 19" panel - black	■	10/100

Ethernet/Ethernet doublers 100 base T

0335 39	FTP - 9 contacts	■	1/10
0335 38	UTP - 8 contacts	■	1/10



0335 39

Telephone/Ethernet doublers 100 base T

0335 37	FTP - 9 contacts	■	1/10
0335 36	UTP - 8 contacts	■	1/10

Telephone/telephone doubler

0335 35	45 contacts	■	1/10
---------	-------------	---	------

Video streaming unit

0335 34	Block of 6 "F" connectors for video circuits	■	1/10
---------	---	---	------



0335 34

Fibre optic units

Monomode fibre units (9/125 µm)

0335 13	LC unit for 6 monomode fibres	■	1/10
0335 12	SC unit for 6 monomode fibres	■	1/10



0335 12

* MRP - Maximum Retail Price Inclusive of all taxes.

Red Cat.Nos - new products

■ Price available on request.

▲ Refer page no 76

** Refer page no 79

Cabling system LCS² category cat. 6A, LCS² cat. 6, LCS² cat. 5e

Cat.Nos	Description	MRP* ₹ / Unit	Pack
---------	-------------	------------------	------

Fibre optic units

Multimode fibre units (62.5 and 50/125 µm)

0335 16	ST unit for 6 multimode fibres	■	1/10
0335 17	SC unit for 6 multimode fibres	■	1/10
0335 18	LC unit for 6 multimode fibres	■	1/10
0335 19	High-density LC unit for 12 multimode fibres	■	1/10



0335 16

Blanking plates

0517 40	Set of 12 blanking plugs for RJ 45 LCS ² connector white	■	10/100
0517 41	Set of 12 blanking plugs for RJ 45 LCS ² connector black	■	10/100
0335 91	Blanking plate for 19" panel black	■	10/100

Ethernet switches 100 Mbps

Switch units for patch panel

0335 02	7 RJ 45 ports at the front, 1 of which is a cascade port	■	1/8
0335 05	6 RJ 45 ports + 1 LC type optic port with front- mounted cascade 100 base FX type LC	■	1/8



0335 02

Boxes to be installed on shelf

0332 93	5 RJ 45 port switch	■	1/10
0332 91	8 RJ 45 port switch	■	1/10



0332 93

Mini shelf

0332 81	For switch Cat.Nos 0332 91/93	■	1/5
---------	----------------------------------	---	-----

Copper/fibre optic converter units

0335 06	10/100 base T to 10/100 base FX type SC	■	1/5
0335 07	1000 base T to 1000 base SX type SC	■	1/5

Midspan Power over Ethernet (PoE) injectors

0335 01	4 inlets/outlets	■	1/10
0327 37	1 inlet / outlet	■	1/20



0335 01



0327 37

Cabling system LCS² doubler sockets and accessories

RJ 45 doubler sockets

5723 36	Telephone/Ethernet Arteor™ - FTP - 9 contacts	■	10/100
5728 36	Telephone/Ethernet Arteor™ - FTP - 9 contacts	■	10/100



5723 36

Bold Cat.Nos are products normally available with Legrand (India) Stockists. Cat.Nos that are not bold - delivery within 4 - 8 weeks from the date of order. Bold packing quantity is our mandatory packing. Orders to be placed by Legrand (India) Stockiest in multiples of the same.

Cabling system LCS² doubler sockets and accessories



5728 35

Cat.Nos	Description	MRP* ₹ / Unit	Pack
RJ 45 doubler sockets			
5723 35	Telephone/Ethernet Arteor™ - UTP - 8 contacts	■	10/100
5728 35	Telephone/Ethernet Arteor™ - UTP - 8 contacts	■	10/100

Mobile doublers

0327 83	TV/computer network or telephone double connector	■	10/100
0327 47	Telephone/telephone doubler	■	10/100
0327 45	Computer network/telephone doubler	■	10/100
0327 46	L1/L2 telephone doubler	■	10/100
0327 48	Computer network/computer network double connector	■	10/100

Weatherproof adaptors



0539 49

0695 80	Adapter with smoked flap	■	10/100
0695 79	Adapter with smoked flap lockable by special tool	■	1/10
0695 81	Adapter for RJ socket	■	1/100
0919 45	Locking tool	■	1/100
0778 80	Soliroc adapter with flap	■	1/20
0778 81	Soliroc adapter without flap	■	1/20
0539 49	IP 55 hypra adapter base	■	5/25

Cable protection accessories



0533 00

0533 00	Plug - Integrated PE with sealing ring and clamping blades	■	3/30
0533 01	Flush-mounting base - locking base	■	3/30
0533 02	Kit - flush - mounting base + plug	■	3/30
0533 03	Protective flap - fits on base Cat.No 0533 01	■	3/12

RJ plugs for round cables



0533 01

0517 01	RJ 11 - 4 contacts, width 9.65 mm	■	50/1000
0517 02	RJ 12 - 6 contacts, width 9.65 mm	■	50/1000
0517 03	RJ 45 cat. 5e - 8 contacts, width 11.70 mm	■	50/1000
0517 04	width 11.70 mm 9 contacts, width 11.70 mm	■	50/1000
0517 06	RJ 45 sleeves black	■	50/1000
0517 07	RJ 45 sleeves white	■	50/1000

Stripping tool

0332 62	Stripper for twisted pair and fibre optic cable	■	1/20
0327 60	Cutting pliers - cuts wires cleanly without damaging the copper	■	1/50

* MRP - Maximum Retail Price Inclusive of all taxes.
■ Price available on request.

Cabling system LCS² doubler sockets and accessories



0517 09

Cat.Nos	Description	MRP* ₹ / Unit	Pack
Crimping tool for RJ 45 plugs			
0517 09	Tool with 3 crimping points	■	1/10
110 tool			
0332 60	110 tool	■	1/77
0332 61	Replacement blade	■	5/330

Cabling system LCS² telephone panels, units and cables

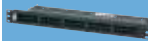

0335 79

Patch panel telephone 50 ports 110 connect			
0335 79	19" panel - 1 U	■	1

Cables for telephone networks cat. 3

0328 91	U/UTP - 50 pairs - length 500 m	■	500 ⁽¹⁾
0328 88	U/UTP - 100 pairs - length 500 m	■	500 ⁽¹⁾

Panels and units for incoming telephone

Panels assembled - 1 U

0335 31	3-6/4-5 contacts for digital telephone	■	1/3
0335 30	4-5/7-8 contacts for analogue telephone	■	1/3

Incoming telephone units for self-assembly panels

0335 33	3-6/4-5 contacts for digital telephone	■	2/40
0335 32	4-5/7-8 contacts for analogue telephone	■	2/40

Wi-Fi

switches, distributors and Wi-Fi access points

Flush-mounting 10/100 base T switches



5720 83

5720 84	Arteor™ white - non-manageable PoE power supply	■	1/10
5728 84	Arteor™ - PoE power supply magnesium	■	1/10
5720 83	230 VA power supply Arteor™ - white	■	1/10
5728 83	230 VA power supply Arteor™ - magnesium	■	1/10
5720 85	Arteor™-white - manageable 230 VA power supply	■	1/10
5728 85	230 VA power supply Arteor™ - magnesium	■	1/10

Manageable Wi-Fi access points 802.11a & b/g



5723 76

5723 76	With RJ 45 socket on front white - Arteor™	■	1/10
5728 76	With RJ 45 socket on front magnesium - Arteor™	■	1/10
5723 77	With no RJ 45 socket white - Arteor™	■	1/10
5728 77	With no RJ 45 socket magnesium - Arteor™	■	1/10

Bold Cat.Nos are products normally available with Legrand (India) Stockists. Cat.Nos that are not bold - delivery within 4 - 8 weeks from the date of order. Bold packing quantity is our mandatory packing. Orders to be placed by Legrand (India) Stockiest in multiples of the same.

Wi-Fi

switches, distributors and Wi-Fi access points

Cat.Nos	Description	MRP* ₹ / Unit	Pack
---------	-------------	------------------	------

Manageable Wi-Fi access points 802.11a & b/g

5723 78	With no RJ 45 socket white - Arteor™	■	1/10
5728 78	With no RJ 45 socket magnesium - Arteor™	■	1/10

Manageable Wi-Fi access points 802.11n

0335 22	Wi-Fi wall/surface mounted access point 802.11n	■	1/10
0335 21	Wi-Fi ceiling mounted access point 802.11n	■	1/10

Wi-Fi network management system

0335 25	Controller 5APs	■	1
0335 26	Extension licence up to 10 AP	■	1
0335 27	Extension licence up to 25 AP	■	1
0335 24	Access point manager	■	1/10

Midspan Power over Ethernet (PoE) injectors

0335 01	4 inlets/outlets	■	1/10
0327 37	1 inlet / outlet	■	1/20

Cabling system LCS²

Fibre optic

fibre cables

OS 1 singlemode optical cables (9/125 µm)

Yellow jacket

0325 12	Indoor/outdoor 6 fibres	■	2000 ⁽¹⁾
0325 13	Outdoor, corrugated steel tape 6 fibres	■	2000 ⁽¹⁾
0325 14	Indoor/outdoor 12 fibres	■	2000 ⁽¹⁾
0325 50	Indoor/outdoor 12 fibres - 900 µm	■	2000 ⁽¹⁾
0325 15	Outdoor, corrugated steel tape 12 fibres	■	2000 ⁽¹⁾
0325 51	Indoor/outdoor 24 fibres	■	2000 ⁽¹⁾

OM 3 multimode optical cables (50/125 µm)

Green jacket

0325 10	Indoor/outdoor 6 fibres	■	2000 ⁽¹⁾
0325 11	Indoor/outdoor 12 fibres	■	2000 ⁽¹⁾
0325 52	Indoor/outdoor 24 fibres	■	2000 ⁽¹⁾
0325 53	Indoor/outdoor 24 fibres	■	2000 ⁽¹⁾

OM 2 multimode optical cables (50/125 µm)

Orange jacket

0325 54	Indoor/outdoor 2 fibres	■	2000 ⁽¹⁾
0325 59	Indoor/outdoor 4 fibres	■	2000 ⁽¹⁾
0325 55	Indoor/outdoor 4 fibres	■	2000 ⁽¹⁾
0325 04	Indoor/outdoor 6 fibres	■	2000 ⁽¹⁾
0325 08	Indoor/outdoor 6 fibres	■	2000 ⁽¹⁾
0325 05	Outdoor, corrugated steel tape 6 fibres	■	2000 ⁽¹⁾
0325 06	Indoor/outdoor 12 fibres	■	2000 ⁽¹⁾
0325 09	Indoor/outdoor 12 fibres	■	2000 ⁽¹⁾
0325 07	Outdoor, corrugated steel tape	■	2000 ⁽¹⁾
0325 60	Indoor/outdoor 12 fibres	■	2000 ⁽¹⁾
0325 58	Indoor/outdoor 24 fibres	■	2000 ⁽¹⁾

* MRP - Maximum Retail Price Inclusive of all taxes.

■ Price available on request.

(1) in meters

Cabling system LCS²

fibre optic

Cat.Nos	Description	MRP* ₹ / Unit	Pack
---------	-------------	------------------	------

OM 1 multimode optical cables (62.5/125 µm)

Orange jacket

0325 00	Indoor/outdoor 6 fibres	■	2000 ⁽¹⁾
0325 01	Indoor/outdoor 12 fibres	■	2000 ⁽¹⁾

Case and rapid crimping connectors

Rapid crimping connectors 900 µm

Monomode connectors

0331 12	LC connector for 9/125 µm fibres	■	10/200
0331 13	SC connector for 9/125 µm fibres	■	10/200

Rapid crimping connectors 900 µm

Multimode connectors

0331 06	LC 10 Gb connector for 50/125 µm	■	10/200
0331 07	SC 10 Gb connector for 50/125 µm	■	10/200
0331 08	ST 10 Gb connector for 50/125 µm	■	10/200
0331 09	LC connector for 62.5/125 µm fibre	■	10/200
0331 10	SC connector for 62.5/125 µm fibre	■	10/200
0331 11	ST connector for 62.5/125 µm fibre	■	10/200

Installation case for rapid crimping connector

0331 93	Used for quick and simple installation of ST, SC or LC fibre connectors	■	1
---------	---	---	---

Pigtails

10 Gb - 50/125 µm

0326 22	SC connector	■	6/60
0326 23	LC connector	■	6/60
0326 27	6 x LC-PC connectors	■	1/5
0326 26	12 x LC-PC connectors	■	1/5

9/125 µm

0326 20	SC connector	■	6/60
0326 21	LC connector	■	6/60
0326 25	6 x LC-UPC connectors	■	1/5
0326 24	12 x LC-UPC connectors	■	1/5

Thermoretractable sleeve for pigtails

0327 44	40 mm-pack of 50 sleeves	■	1/10
---------	--------------------------	---	------

Glue-on connectors 50/125 and 62.5/125 µm

0331 27	ST connector	■	10/200
0331 47	SC connector	■	10/200
0331 00	LC connector	■	10/200

Spreaders

0330 48	6 fibre spreader	■	1/10
0330 49	12 fibre spreader	■	1/10

Bold Cat.Nos are products normally available with Legrand (India) Stockists. Cat.Nos that are not bold - delivery within 4 - 8 weeks from the date of order. Bold packing quantity is our mandatory packing. Orders to be placed by Legrand (India) Stockiest in multiples of the same.

Cabling system LCS² fibre optic

Cat.Nos	Description	MRP* ₹ / Unit	Pack
19" optic drawers			
0335 10	Modular optic drawer	■	1
Fibre optic units			
Monomode fibre units (9/125 µm)			
0335 13	LC unit for 6 monomode fibres	■	1/10
0335 12	SC unit for 6 monomode fibres	■	1/10
Multimode fibre units (62.5 and 50/125 µm)			
0335 16	ST unit for 6 multimode fibres	■	1/10
0335 17	SC unit for 6 multimode fibres	■	1/10
0335 18	LC unit for 6 multimode fibres	■	1/10
0335 19	High-density LC unit for 12 multimode fibres	■	1/10
Switch/fibre optic unit			
0335 05	6 x RJ 45 ports + 1 cascade LC type optic port at the front	■	1/8
Copper/fibre optic converter units			
0335 06	10/100 base T to 10/100 base FX type SC	■	1/5
0335 07	1000 base T to 1000 base SX type SC	■	1/5
Fibre optic cassette for patch panel			
0335 11	Ensures fibre coiling (from 2 to 12 fibres)	■	1/5
Blanking plate for 19" panel			
0335 91	Black	■	10/100
19" high density optic drawer			
0325 69	Modular optical drawer	■	1
Fibre optic units			
Monomode fibre units (9/125 µm)			
0325 73	LC duplex unit for 6 monomode fibres - blue	■	3/30
0325 74	LC duplex unit for 12 monomode fibres - blue	■	3/30
0325 70	ST duplex unit for 6 monomode fibres - blue	■	3/30
0325 71	SC duplex unit for 6 monomode fibres - blue	■	3/30
0325 72	MPO unit type A for 6 monomode fibres - blue	■	3/30
Multimode fibre units (62.5 and 50/125 µm)			
0325 78	LC duplex unit for 6 multimode fibres - beige	■	3/30
0325 79	LC duplex unit for 12 multimode fibres - beige	■	3/30
0325 75	ST duplex unit for 6 multimode fibres - beige	■	3/30
0325 76	SC duplex unit for 6 multimode fibres - beige	■	3/30
0325 77	MPO unit type A for 6 multimode fibres - beige	■	3/30

* MRP - Maximum Retail Price Inclusive of all taxes.
■ Price available on request.

Cabling system LCS² fibre optic

Cat.Nos	Description	MRP* ₹ / Unit	Pack
Accessory			
0335 93	Blanking plate	■	10
Accessories common to 2 optical drawers			
Cassette for pigtailed			
0329 07	12 fibre capacity	■	1/10
Bend limiting clip			
0335 94	Fibre management bend limiting clip	■	10
Fibre sockets			
0786 16	Socket with fibre optic feedthrough 2 x ST - white	■	1/20
0786 17	Socket with fibre optic feedthrough 2 x SC - white	■	1/20
0786 18	Socket with fibre optic feedthrough 2 x LC - white	■	1/20
Zone distribution boxes			
Self-assembly zone distribution box			
0335 40	Used for fitting fibre optic accessory units	■	1/10
Fibre optic accessory			
0335 20	Used for fitting fibre optic units and the fibre coil in the zone distribution box	■	1/10
Sockets with fibre optic feedthrough			
0786 16	Socket with fibre optic feedthrough 2 x ST - white	■	1/20
0786 17	Socket with fibre optic feedthrough 2 x SC - white	■	1/20
0786 18	Socket with fibre optic feedthrough 2 x LC - white	■	1/20
Patch cords			
OS 1 (UPC) monomode optical cords			
0326 00	SC/SC duplex cords length: 1 m	■	3/30
0326 01	SC/SC duplex cords length: 2 m	■	3/30
0326 02	SC/SC duplex cords length: 3 m	■	3/30
0326 03	SC/LC duplex cords length: 1 m	■	3/30
0326 04	SC/LC duplex cords length: 2 m	■	3/30
0326 05	SC/LC duplex cords length: 3 m	■	3/30
0326 06	LC/LC duplex cords length: 1 m	■	3/30
0326 07	LC/LC duplex cords length: 2 m	■	3/30
0326 08	LC/LC duplex cords length: 3 m	■	3/30
OM 3 multimode optical cords (50/125 µm)			
0326 09	SC/SC duplex cords length: 1 m	■	3/30
0326 10	SC/SC duplex cords length: 2 m	■	3/30
0326 11	SC/SC duplex cords length: 3 m	■	3/30
0326 12	SC/LC duplex cords length: 1 m	■	3/30

Bold Cat.Nos are products normally available with Legrand (India) Stockists. Cat.Nos that are not bold - delivery within 4 - 8 weeks from the date of order. Bold packing quantity is our mandatory packing. Orders to be placed by Legrand (India) Stockiest in multiples of the same.

Cabling system LCS² fibre optic

Cat.Nos	Description	MRP* ₹ / Unit	Pack
---------	-------------	------------------	------

OM 3 multimode optical cords (50/125 µm)

0326 13	SC/LC duplex cords length: 2 m	■	3/30
0326 14	SC/LC duplex cords length: 3 m	■	3/30
0326 15	LC/LC duplex cords length: 1 m	■	3/30
0326 16	LC/LC duplex cords length: 2 m	■	3/30
0326 17	LC/LC duplex cords length: 3 m	■	3/30

OM 2 multimode optical cords (50/125 µm)

0330 80	ST/ST duplex cords length: 1 m	■	3/30
0330 81	ST/ST duplex cords length: 2 m	■	3/30
0330 82	ST/ST duplex cords length: 3 m	■	3/30
0330 69	SC/SC duplex cords length: 1 m	■	3/30
0330 70	SC/SC duplex cords length: 2 m	■	3/30
0330 71	SC/SC duplex cords length: 3 m	■	3/30
0330 72	ST/SC duplex cords length: 2 m	■	3/30
0330 73	ST/SC duplex cords length: 3 m	■	3/30
0330 61	LC/LC duplex cord length: 2 m	■	3/30
0330 75	SC/LC duplex cords length: 1 m	■	3/30
0330 63	SC/LC duplex cords length: 2 m	■	3/30
0330 76	SC/LC duplex cords length: 3 m	■	3/30
0330 65	LC/ST duplex cord length: 2 m	■	3/30

OM 1 multimode optical cords (62.5/125 µm)

0331 51	SC/SC duplex patch cords length: 1 m	■	3/30
0331 52	SC/SC duplex patch cords length: 2 m	■	3/30
0331 53	SC/SC duplex patch cords length: 3 m	■	3/30
0331 57	ST/SC duplex patch cords length: 1 m	■	3/30
0331 58	ST/SC duplex patch cords length: 2 m	■	3/30
0330 77	LC/SC duplex patch cords length: 1 m	■	3/30
0330 62	LC/SC duplex patch cords length: 2 m	■	3/30
0330 78	LC/SC duplex patch cords length: 3 m	■	3/30

* MRP - Maximum Retail Price Inclusive of all taxes.
■ Price available on request.



0326 13



0326 16



0330 70



0330 65

Cabling system LCS² fibre optic

Cat.Nos	Description	MRP* ₹ / Unit	Pack
---------	-------------	------------------	------

Arteor™

Audio and video sockets

2 x female RCA

5722 72	White square version 22.5 x 45 mm - 1 module	■	1/20
5727 72	Magnesium square version 22.5 x 45 mm - 1 module	■	1/20
5732 72	White round version 45 x 45 mm - 2 modules	■	1/20
5737 72	Magnesium round version 45 x 45 mm - 2 modules	■	1/20



5722 72

3 x female RCA

5722 73	White square version 22.5 x 45 mm - 1 module	■	1/20
5727 73	Magnesium square version 22.5 x 45 mm - 1 module	■	1/20
5732 73	White round version 45 x 45 mm - 2 modules	■	1/20
5737 73	Magnesium round version 45 x 45 mm - 2 modules	■	1/20



5737 73

Cabling system LCS²

Audio and video sockets

Female 3.5 mm jack - square version

5722 74	Connection on screw terminals white 22.5 x 45 mm - 1 module	■	1/20
5727 74	Connection on screw terminals magnesium 22.5 x 45 mm - 1 module	■	1/20
5722 78	White solder connection 22.5 x 45 mm - 1 module	■	1/20
5727 78	Magnesium solder connection 22.5 x 45 mm - 1 module	■	1/20



5722 74

YUV - square version

5722 71	White 1 module 22.5 x 45 mm	■	1/20
5727 71	Magnesium 1 module 22.5 x 45 mm	■	1/20



5727 71

HDMI

5722 81	White square version 45 x 45 mm - 2 modules	■	1/20
5727 81	Magnesium square version 45 x 45 mm - 2 modules	■	1/20
5722 85	White round version 45 x 45 mm - 2 modules	■	1/50
5727 85	Magnesium round version 45 x 45 mm - 2 modules	■	1/50



5727 85

S-video sockets (4-pin mini-DIN)

5744 01	White square version	■	1/20
5744 51	Magnesium square version	■	1/20
5745 01	White round version	■	1/20
5745 51	Magnesium round version	■	1/20

Bold Cat.Nos are products normally available with Legrand (India) Stockists. Cat.Nos that are not bold - delivery within 4 - 8 weeks from the date of order. Bold packing quantity is our mandatory packing. Orders to be placed by Legrand (India) Stockiest in multiples of the same.

Cabling system LCS²

Cat.Nos	Description	MRP* ₹ / Unit	Pack
---------	-------------	------------------	------

Female BNC 75

5722 76	White 22.5 x 45 mm - 1 module	■	1/20
5727 76	Magnesium 22.5 x 45 mm - 1 module	■	1/20

Female HD 15

5722 82	Connection on screw terminals - white 45 x 45 mm - 2 modules	■	1/20
5727 82	Connection on screw terminals - magnesium 45 x 45 mm - 2 modules	■	1/20
5722 79	Solder connection - white 22.5 x 45 mm - 1 module	■	1/20
5727 79	Solder connection magnesium 22.5 x 45 mm - 1 module	■	1/20

Female HD 15 + jack 3.5 mm

5722 88	White square version 45 x 45 mm - 2 modules	■	1/20
5727 88	Magnesium square version 45 x 45 mm - 2 modules	■	1/20
5722 89	White round version 45 x 45 mm - 2 modules	■	1/50
5727 89	Magnesium round version 45 x 45 mm - 2 modules	■	1/50

HD 15 amplifier + jack kit

5723 70	White 4-module HD 15 connector and a 3.5 mm jack	■	1/10
5728 70	Magnesium 4-module HD 15 connector and a 3.5 mm jack	■	1/10

Equipment cords

0517 20	HDMI cord length 10 m	■	1/5
0517 22	HD 15 cord + 3.5 mm Jack cord length 2 m	■	1/5
0779 30	HDMI booster	■	1/45

Cables

0327 80	HDMI cable length 20 m	■	1/3
0327 81	VGA cable length 20 m	■	1/3

Cabling system LCS²

19" LCS² server enclosures

Server enclosures

0463 85	600 x 1000 x 630 mm	■	1
0463 86	800 x 1000 x 630 mm	■	1

Accessories

0464 82	Set of 4 caster wheels	■	1
0465 17	Shelves - fixed shelf depth 850 mm, 100 kg	■	1
0465 18	Shelves - telescopic shelf depth 850 mm, 100 kg	■	1
0464 78	Cable guide supports For width 600/800 mm	■	1
0464 79	Cable guide supports For width 1000 mm	■	1

* MRP - Maximum Retail Price Inclusive of all taxes.
■ Price available on request.

Cabling system LCS²

19" LCS² enclosures

Cat.Nos	Description	MRP* ₹ / Unit	Pack
---------	-------------	------------------	------

Earth braid

0347 95	Capacity - 6, fixing spacing 200 mm	■	20/440
---------	--	---	--------

19" LCS² enclosures

0463 00	Capacity 24 U 600 x 600 x 240 mm	■	1
0463 06	Capacity 29 U 600 x 600 x 290 mm	■	1
0463 12	Capacity 33 U 600 x 600 x 330 mm	■	1
0463 18	Capacity 42 U 600 x 600 x 420 mm	■	1
0463 19	Capacity 42 U 600 x 800 x 420 mm	■	1
0463 21	Capacity 42 U 800 x 600 x 420 mm	■	1
0463 22	Capacity 42 U 800 x 800 x 420 mm	■	1
0463 23	Capacity 42 U 800 x 1000 x 420 mm	■	1
0463 28	Capacity 47 U 800 x 800 x 470 mm	■	1
0463 29	Capacity 47 U 800 x 1000 x 470 mm	■	1

19" LCS² extension enclosures

0463 30	600 x 600 x 420 mm	■	1
0463 33	800 x 800 x 420 mm	■	1

LCS² cabling units

0463 34	Depth 600 mm	■	1
0463 35	Depth 800 mm	■	1

LCS² joining kits

0463 37	Depth 600 mm	■	1
0463 38	Depth 800 mm	■	1
0463 39	Depth 1000 mm	■	1

Cabling system LCS²

Linkeo 19" LCS² enclosures

0463 52	Capacity 33 U - 600 x 600 x 330 mm	■	1
0463 58	Capacity 42 U - 600 x 600 x 420 mm	■	1
0463 59	Capacity 42 U - 600 x 800 x 420 mm	■	1
0463 60	Capacity 42 U - 800 x 600 x 420 mm	■	1
0463 61	Capacity 42 U - 800 x 800 x 420 mm	■	1

Linkeo 19" LCS² extension enclosures

0463 81	Capacity 42 U - 600 x 600 x 420 mm	■	1
0463 84	Capacity 42 U - 800 x 800 x 420 mm	■	1

Linkeo LCS² cabling units

0463 75	Depth 600 mm	■	1
0463 76	Depth 800 mm	■	1

Bold Cat.Nos are products normally available with Legrand (India) Stockists.
Cat.Nos that are not bold - delivery within 4 - 8 weeks from the date of order.
Bold packing quantity is our mandatory packing. Orders to be placed by
Legrand (India) Stockiest in multiples of the same.

Cabling system LCS²

Linkeo 19" LCS² enclosures

Cat.Nos	Description	MRP* ₹ / Unit	Pack
---------	-------------	------------------	------

Linkeo LCS² joining kits

0463 78	Depth 600 mm	■	1
0463 79	Depth 800 mm	■	1

Linkeo 19" LCS² uprights

0463 72	33 U	■	1
0463 73	42 U	■	1

Enclosure bases

0464 50	Plinth kits enclosure width 600 mm height 100	■	1
0464 52	Plinth kits enclosure width 600 mm height 200	■	1
0464 51	Plinth kits enclosure width 800 mm height 100	■	1
0464 53	Plinth kits enclosure width 800 mm height 200	■	1
0464 54	Sets of 2 solid side traps enclosure width 600 mm	■	1
0464 56	Sets of 2 solid side traps enclosure width 800 mm	■	1
0464 58	Sets of 2 solid side traps enclosure width 1000 mm	■	1
0464 60	Ventilated traps enclosure width 600 mm	■	1
0464 61	Ventilated traps enclosure width 800 mm	■	1
0464 62	Traps with brush enclosure width 600 mm	■	1
0464 63	Traps with brush enclosure width 800 mm	■	1

0464 61

0464 63

Cabling system LCS²

enclosure bases

Base for cabling units

0464 64	Assembled at front or rear between the bases of associated enclosures	■	1/4
---------	---	---	-----

Stay plates

0476 93	enclosure width 600 mm	■	1
0476 94	enclosure width 800 mm	■	1
0476 95	enclosure width 1000 mm	■	1

Linking interface

0464 66	For enclosure depth 600 mm	■	1
---------	----------------------------	---	---

0464 66

Cabling system LCS²

cable inlets and thermal management for enclosures

19" cable entry inlets

0465 28	Plastic with brushes, snap on 1 U	■	1/80
0465 29	Plastic with brushes, snap on 2 U	■	1/40
0465 32	Solid plastic, direct clipping 1 U	■	1/80
0465 33	Solid plastic, direct clipping 2 U	■	1/40
0465 30	Metal with brushes 1 U	■	1/8
0465 31	Metal with brushes 2 U	■	1/4
0465 38	Solid metal - 1 U	■	1/8
0465 39	Solid metal - 2 U	■	1/4
0465 40	Solid metal - 3 U	■	1/4

0465 29

0465 32

* MRP - Maximum Retail Price Inclusive of all taxes.
■ Price available on request.

Cabling system LCS²

cable inlets and thermal management for enclosures

Cat.Nos	Description	MRP* ₹ / Unit	Pack
---------	-------------	------------------	------

Thermal management

0464 87	19" 3 U plates with fans 2 x 230 VA fans	■	1
0464 88	19" 3 U plates with fans 3 x 230 VA fans	■	1
0464 89	1 U ventilation drawers 19" ventilation shelf with 2 fans - depth 150 mm	■	1
0464 90	1 U ventilation drawers 19" ventilation shelf with 4 fans - depth 300 mm	■	1
0348 48	Thermostat adjustable from 5 to 60 °C, 12 V to 250 VA	■	1/25

Accessories

0464 83	Set of 4 casters for LCS ² enclosure (excludes server enclosure)	■	1
0464 85	Lighting kit with switch	■	1
0464 84	Level adjustment kit	■	1
0464 86	Floor fixing kit	■	1/10

Self-adhesive document holders for plans

0365 80	Open - RAL 7035 depth 18 mm	■	20
0365 81	Open - RAL 7035 depth 18 mm	■	20
0365 82	Closed - RAL 9002 stiff, plastic, IP 50	■	1/10
0097 99	Transparent soft plastic, A4 - 305 x 220 mm	■	10/100

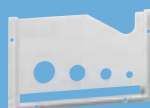

0365 81



0365 82

Cabling system LCS²

Altis™ enclosures

19" 42 U Altis enclosures

0473 62	Glass door enclosures depth 600 mm	■	1
0473 63	Glass door enclosures depth 600 mm	■	1
0473 91	Glass door enclosures depth 800 mm	■	1
0473 92	Glass door enclosures depth 800 mm	■	1
0472 72	Set of 2 side panels depth 2000 x 600 mm	■	1
0472 75	Set of 2 side panels depth 2000 x 600 mm	■	1
0482 20	Set of 2 42 U uprights (perforations 9.4 x 9.5 mm)	■	1
0476 83	Interior assembly kit - IP 55 for a 1000 kg/m ³ load	■	1
0476 96	M 14 lifting rings Set of 4 rings For a load of 1000 kg/m ³	■	1

0473 62

+ 0472 72

+ 0482 20

0473 63

0473 62

+ 0472 72

+ 0482 20

0473 63

0473 63

Bold Cat.Nos are products normally available with Legrand (India) Stockists. Cat.Nos that are not bold - delivery within 4 - 8 weeks from the date of order. **Bold packing quantity** is our mandatory packing. Orders to be placed by Legrand (India) Stockiest in multiples of the same.

Cabling system LCS² 19" LCS² equipment

Cat.Nos	Description	MRP* ₹ / Unit	Pack
Fixed shelves			
Projecting mounting on 2 x 19" uprights			
0465 01	Depth 115 mm	■	1
0465 02	Depth 200 mm	■	1
0465 02	Depth 360 mm	■	1
Quick fixing on 4 x 19" uprights			
0465 05	Depth 450 mm	■	1
0465 06	Depth 650 mm	■	1
0465 07	Depth 850 mm	■	1
Screw fixed on 4 x 19" uprights			
0465 17	Depth 850 mm	■	1
Telescopic shelves			
Quick fixing on 4 x 19" uprights			
0465 08	Depth 450 mm	■	1
0465 09	Depth 650 mm	■	1
0465 10	Depth 650 mm	■	1
Screw fixed on 4 x 19" uprights			
0465 18	Depth 850 mm	■	1
Fixed runners			
0465 11	For enclosure depth 600 mm	■	1
0465 12	For enclosure depth 800 mm	■	1
0465 13	For enclosure depth 1000 mm	■	1
Keypad support shelf			
0465 19	Screw fixed on 4 x 19" uprights	■	1
230 VA power supply units			
6339 10	5 x 2P + sockets + switch	■	1
6339 11	5 x 2P + sockets + MBC	■	1
0775 41	Replacement module for surge suppressor	■	1/50
0332 79	Modular unit	■	1/8
DIN rail kit IP 2X			
0465 45	For assembling Lexic modular appliances	■	1

Cabling system LCS² LCS² cable management

Enclosure cable and cord management

0464 72	Set of 3 cable management supports for enclosure width/depth 600 mm	■	1
0464 73	Set of 3 cable management supports for enclosure width/depth 800 mm	■	1
0464 74	Set of 3 cable management supports for enclosure depth 1000 mm	■	1

* MRP - Maximum Retail Price Inclusive of all taxes.
■ Price available on request.
(1) Can also be installed in 19" Altis width 800 mm

Cabling system LCS² LCS² cable management

Cat.Nos	Description	MRP* ₹ / Unit	Pack
Enclosure cable and cord management			
0464 76	Flat cable guides for enclosure 33 U	■	1
0464 77	Flat cable guides for 42 U enclosures	■	1
0464 69	U cable guides 3000 x 200 x 54 mm	■	1
0464 70	U cable guides 3000 x 400 x 54 mm	■	1
0331 35 ⁽¹⁾	Cable management grille guard with articulated bolts	■	1
0464 80 ⁽¹⁾	Vertical feedthrough	■	1
0464 81	Patch extension - set of 2 uprights allowing 12 U	■	1
19" feedthrough panels			
0465 22	Metal, 2 axes 1 U	■	1/10
0465 23	Metal, 2 axes 2 U	■	1/8
0465 28	Plastic with brushes, snap on 1 U	■	1/80
0465 29	Plastic with brushes, snap on 2 U	■	1/40
0465 30	Metal with brushes 1 U	■	1/8
0465 31	Metal with brushes 2 U	■	1/4
19" blanking plates			
0465 32	Solid plastic, direct clipping 1 U	■	1/80
0465 33	Solid plastic, direct clipping 2 U	■	1/40
0465 38	Solid metal 1 U	■	1/8
0465 39	Solid metal 2 U	■	1/4
0465 40	Solid metal 3 U	■	1/4
Cable guide connecting rings			
0465 41	1 U, plastic. Useable section 1890 mm ²	■	4/80
0465 42	2 U, plastic. Useable section 4,070 mm ²	■	4/80
Fixing screws			
0364 53	With 8.5 mm cage nuts	■	1/10
0364 54	With 9.5 mm cage nuts	■	1/20
Cabling system LCS² 19" LCS² cabinets and accessories			
Wall-mounting 19" LCS² cabinets			
0462 00	Cabinet depth 400 mm capacity 6 U	■	1
0462 01	Cabinet depth 400 mm capacity 9 U	■	1
0462 02	Cabinet depth 400 mm capacity 12 U	■	1
0462 03	Cabinet depth 400 mm capacity 16 U	■	1
0462 06	Cabinet depth 580 mm capacity 9 U	■	1
0462 07	Cabinet depth 580 mm capacity 12 U	■	1
0462 08	Cabinet depth 580 mm capacity 16 U	■	1
0462 09	Cabinet depth 580 mm capacity 21 U	■	1

Bold Cat.Nos are products normally available with Legrand (India) Stockists. Cat.Nos that are not bold - delivery within 4 - 8 weeks from the date of order. Bold packing quantity is our mandatory packing. Orders to be placed by Legrand (India) Stockiest in multiples of the same.

Cabling system LCS² 19" LCS² cabinets and accessories

Cat.Nos	Description	MRP* ₹ / Unit	Pack
---------	-------------	------------------	------

Pivoting 19" LCS² cabinets

0462 11	Cabinet depth 600 mm capacity 9 U	■	1
0462 12	Cabinet depth 600 mm capacity 12 U	■	1
0462 13	Cabinet depth 600 mm capacity 16 U	■	1
0462 14	Cabinet depth 600 mm capacity 21 U	■	1

Fixed shelves

0465 00	Projecting mounting on 2 x 19" uprights depth 115 mm	■	1
0465 01	Projecting mounting on 2 x 19" uprights depth 200 mm	■	1
0465 02	Projecting mounting on 2 x 19" uprights depth 360 mm	■	1

Thermal management

0462 60	Fan 230 VA fan	■	1/10
0348 48	Thermostat adjustable from 5 to 60 °C, 12 V to 250 VA	■	1/25

Cable entry

0462 55	Cable entry plate with brush	■	1
---------	------------------------------	---	---

Accessories

0462 64	Set of 4 casters for assembly on pivoting cabinets	■	1
---------	--	---	---

Cabling system LCS² Linkeo 19" LCS² cabinets

Linkeo 19" LCS² wall-mounting cabinets

0462 30	Capacity 6 U 367 x 600 x 400 mm	■	1
0462 31	Capacity 9 U 500 x 600 x 400 mm	■	1
0462 42	Capacity 12 U 625 x 600 x 600 mm	■	1
0462 43	Capacity 16 U 810 x 600 x 600 mm	■	1

Linkeo LCS² fan kit

0462 70	Kit contains: 2 fans, 1 thermostat, ON/OFF switch	■	1
---------	---	---	---

* MRP - Maximum Retail Price Inclusive of all taxes.
■ Price available on request.

Cabling system LCS² 10" LCS² cabinet for small business

Cat.Nos	Description	MRP* ₹ / Unit	Pack
---------	-------------	------------------	------

10" LCS² cabinet

0462 20	300 mm depth cabinet capacity 6 U	■	1
---------	-----------------------------------	---	---

10" equipments

0335 92	Modular empty panel 10" panel - 1 U	■	1/10
0462 23	Fixed shelf 1 U depth 120 mm	■	1/12
0462 25	230 V ac power supply units	■	1/10
0462 26	4 x 2P+E Schuko sockets, black	■	1/10

Cabling system LCS² cabinets

Wall mounting cabinets

6348 05	6U capacity cabinet dimension 371.30 x 600 x 500 mm	■	1
6348 06	9U capacity cabinet 504.65 x 600 x 500 mm	■	1
6348 07	12U capacity cabinet dimension 638 x 600 x 500 mm	■	1
6348 08	15U capacity cabinet dimension 771.35 x 600 x 500 mm	■	1

Accessories

6348 16	Mounting accessories pkt (20 nos. each of 3)	■	1
6348 17	Cable manager 1U metal	■	1
6348 15	230 V AC 90 CFM fans	■	1
6348 10	Cantilever tray. 1U 225D	■	1
6348 18	Earthing strips 150 mm H	■	1

Free standing cabinets

6348 00	22U capacity cabinet dimension 1124.9 x 800 x 800 mm	■	1
6348 04	27U capacity cabinet dimension 1357 x 800 x 800 mm	■	1
6348 01	36U capacity cabinet dimension 1747.2 x 800 x 800 mm	■	1
6348 02	42U capacity cabinet dimension 2013.9 x 800 x 800 mm	■	1

Accessories

6348 11	Heavy duty shelf support dimension - 600 x 475 mm	■	1
6348 16	Mounting accessories pkt (20 nos. each of 3)	■	1
6348 17	Cable manager 1U metal	■	1
6348 15	230 V AC 90 CFM fans	■	1
6348 18	Earthing strips 150 mm H	■	1

Bold Cat.Nos are products normally available with Legrand (India) Stockists.
Cat.Nos that are not bold - delivery within 4 - 8 weeks from the date of order.
Bold packing quantity is our mandatory packing. Orders to be placed by
Legrand (India) Stockiest in multiples of the same.

Lighting management solution

Putting a stop to energy waste

Sensors



PIR 180° Sensor



PIR 360° Sensor



Ultrasonic 360° Sensor



Dual Technology 360° Sensor



Sustainable development



Energy saving



Code compliance



Economic saving



Sustainable building practice

Lighting control strategies



Vacancy - based control



Occupancy - based control



Dimming control



Scheduled control



Daylight control



for more details, ask for a copy of Lighting Management Solution catalogues

Movement detectors

Cat.Nos	Description	LP* ₹ / Unit	Pack
---------	-------------	-----------------	------

Movement detectors for lighting control

IP 55 direction movement detector with 360° detection angle. For 2000 Watt "incandescent, 230 V halogen," 1000 VA fluroscet

0697 80	White	9704	1/10
0697 40	Grey	9610	1/10
6604 54	Bulkhead Infrared sensor with provision for 60 W bulb 360° detection range	5720	1



0697 80



6604 54

Video door entry systems

Cat.Nos	Description	MRP ₹ / Unit	Pack
---------	-------------	-----------------	------

Colour image digital video door entry system kit

3690 71	Kit video colour handset with street panel & colour monitor	17882	1
3690 76	Additional color monitor for kit 3690 71	15330	1
3690 81	Kit video colour handsfree with street panel & colour monitor	20438	1
3690 86	Additional color monitor for kit 3690 81	18264	1



3690 71



3690 81



Movement Detectors

For lighting control

360° detection range



bticino

D45 SYSTEM

High performance simplified

The D45 system simplifies installation in residential spaces right from a single house to a group of houses to residential complexes with a large number of apartments.



Slim 7" wide screen with alarm function



10" Touch screen internal unit



Audio handset



Entrance panels

*LP - List Price Inclusive of excise duty but exclusive of sales tax or any other taxes.

Red Cat.Nos - new products

Bold Cat.Nos are products normally available with Legrand (India) Stockists. Cat.Nos that are not bold - delivery within 4 - 8 weeks from the date of order. Bold packing quantity is our mandatory packing. Orders to be placed by Legrand (India) Stockist in multiples of the same.

P17 Tempra Pro and Hypra Plugs and Sockets

For safe connection which you can depend on.
Ensures the protection of personnel at electrical installation

**P17 Tempra Pro
plugs and
sockets**



**Hypra prisinter
and Hypra plugs
and sockets**



**P17 Tempra
combined
units**



**Metra
metallic
plugs and
sockets**



**Metallic
plug and
socket DB's**



P17 Tempra Pro IP 44 - LV 16 and 32 A - sockets and plugs

Cat.Nos	Description	MRP* ₹ / Unit	Pack
---------	-------------	------------------	------

Surface mounting sockets

5551 54	200/250 V~, 16 A 2P+E	616	10
5551 58	380/415 V~, 16 A 3P+E	778	10
5551 59	380/415 V~, 16 A 3P+N+E	778	10
5552 54	200/250 V~, 32 A 2P+E	774	5
5552 58	380/415 V~, 32 A 3P+E	984	10
5552 59	380/415 V~, 32 A 3P+N+E	984	10

Panel mounting sockets inclined outlet

5551 84	200/250 V~, 16 A 2P+E	368	10
5551 88	380/415 V~, 16 A 3P+E	574	10
5551 89	380/415 V~, 16 A 3P+N+E	572	10
5552 84	200/250 V~, 32 A 2P+E	600	10
5552 88	380/415 V~, 32 A 3P+E	760	10
5552 89	380/415 V~, 32 A 3P+N+E	760	10

Mobile sockets

5551 04	200/250 V~, 16 A 2P+E	478	10
5551 08	380/415 V~, 16 A 3P+E	564	10
5551 09	380/415 V~, 16 A 3P+N+E	564	10
5552 14	200/250 V~, 32 A 2P+E	642	10
5552 18	380/415 V~, 32 A 3P+E	810	10
5552 19	380/415 V~, 32 A 3P+N+E	806	10

Straight plugs

5551 24	200/250 V~, 16 A 2P+E	338	10
5551 28	380/415 V~, 16 A 3P+E	440	10
5551 29	380/415 V~, 16 A 3P+N+E	440	10
5552 34	200/250 V~, 32 A 2P+E	534	10
5552 38	380/415 V~, 32 A 3P+E	622	10
5552 39	380/415 V~, 32 A 3P+N+E	622	10

P17 Tempra - domestic pin configuration 16 A - 250 V~

Flush-mounting boxes

0577 21	For 2 panel mounting sockets With single fixing centres 70 x 70 mm - 16 A	3562	3
0577 22	For 1 panel mounting socket With single fixing centres 70 x 70 mm - 16 or 32 A (32 A to be fixed horizontally)	2136	3

* MRP - Maximum Retail Price Inclusive of all taxes.

P17 Tempra Pro IP 66/67 LV 16 and 32 A

Cat.Nos	Polarity	MRP* ₹ / Unit	Pack
---------	----------	------------------	------

Surface mounting sockets

5553 54	200/250 V~, 16 A 2P+E	1004	5
5553 58	380/415 V~, 16 A 2P+E	1292	5
5553 59	380/415 V~, 16 A 3P+N+E	1272	5
5554 54	200/250 V~, 32 A 2P+E	1248	5
5554 55	200/250 V~, 32 A 2P+E	2370	5
5554 59	380/415 V~, 32 A 3P+N+E	2336	5

Panel mounting sockets

5553 84	200/250 V~, 16 A 2P+E	732	5
5553 88	380/415 V~, 16 A 2P+E	820	5
5553 89	380/415 V~, 16 A 3P+N+E	820	5
5554 84	200/250 V~, 32 A 2P+E	932	5
5554 88	380/415 V~, 32 A 2P+E	1122	5
5554 89	380/415 V~, 32 A 3P+N+E	1122	5

Mobile sockets

5553 04	200/250 V~, 16 A 2P+E	898	5
5553 08	380/415 V~, 16 A 2P+E	1172	5
5553 09	380/415 V~, 16 A 3P+N+E	1172	5
5554 14	200/250 V~, 32 A 2P+E	1232	5
5554 18	380/415 V~, 32 A 2P+E	1380	5
5554 19	380/415 V~, 32 A 3P+N+E	1386	5

Straight plugs

5553 24	200/250 V~, 16 A 2P+E	782	5
5553 28	380/415 V~, 16 A 2P+E	898	5
5553 29	380/415 V~, 16 A 3P+E	902	5
5554 34	200/250 V~, 32 A 2P+E	1108	5
5554 38	380/415 V~, 32 A 2P+E	1166	5
5554 39	380/415 V~, 32 A 3P+N+E	1166	5

P17 Tempra Pro IP 66/67 LV 32 A for refrigerated containers

Combined unit, plug and mobile socket for refrigerated containers

6571 06	Combined unit with interlocked switched socket - Double mechanical interlock - Cable glands are not supplied	16474	1
---------	--	-------	---

Bold Cat.Nos are products normally available with Legrand (India) Stockists. Cat.Nos that are not bold - delivery within 4 - 8 weeks from the date of order. Bold packing quantity is our mandatory packing. Orders to be placed by Legrand (India) Stockist in multiples of the same.



5552 58



5551 88



5551 08



5551 28



5553 28



0577 22



6571 06

P17 Tempra Pro IP 66/67 LV 32 A for refrigerated containers

Cat.Nos	Polarity	MRP* ₹ / Unit	Pack
---------	----------	------------------	------

Combined unit, plug and mobile socket for refrigerated containers

5554 91	Panel mounting socket	1360	5
5554 21	Mobile socket With cable grip Ø12 to 21.5 mm	1650	5
5554 41	Straight plug With cable grip Ø12 to 21.5 mm	1338	5

P17 Tempra IP 66/67 - LV 63 and 125 A

Surface mounting sockets

0587 40	200/250 V~, 63 A 2P+E	4356	2
0587 44	380/415 V~, 63 A 3P+E	4332	2
0587 45	380/415 V~, 63 A 3P+N+E	4332	2
0591 06	380/415 V~, 125 A 3P+E	12612	2
0591 07	380/415 V~, 125 A 3P+N+E	12612	2

Panel mounting sockets

0587 20	200/250 V~, 63 A 2P+E	3454	2
0587 24	380/415 V~, 63 A 3P+E	3522	2
0587 25	380/415 V~, 63 A 3P+N+E	3314	2
0591 16	380/415 V~, 125 A 3P+E	9966	1
0591 17	380/415 V~, 125 A 3P+N+E	9870	1

Straight plugs

0587 00	200/250 V~, 63 A 2P+E	2924	2
0587 04	380/415 V~, 63 A 3P+E	2970	2
0587 05	380/415 V~, 63 A 3P+N+E	3072	2
0591 26	380/415 V~, 125 A 3P+E	8844	1
0591 27	380/415 V~, 125 A 3P+N+E	8844	1

Mobile sockets

0587 10	200/250 V~, 63 A 2P+E	3730	2
0587 14	380/415 V~, 63 A 3P+E	3690	2
0587 15	380/415 V~, 63 A 3P+N+E	3918	2
0591 36	380/415 V~, 125 A 3P+E	12870	1
0591 37	380/415 V~, 125 A 3P+N+E	12870	1



0587 05



0587 14



0573 00



0577 10



0577 05



0577 12



0577 11



0577 04



0577 14



0577 16

Plugs and sockets

Cat.Nos	Polarity	LP** ₹ / Unit	Pack
---------	----------	------------------	------

P17 combined unit to be equipped

Bases with mechanical super-compact sockets

0573 00	16 A, 2P+E IP 44 Interlock	4356	1
0573 02	16 A, 3P+N+E IP 44 Interlock	4804	1
0573 20	16 A, 2P+E IP 55 Interlock	4886	1
0573 22	16 A, 3P+N+E IP 55 Interlock	5496	1
0577 23	Mounting plate for 2 super-compact mechanical interlock sockets	2442	1

Bases for 125 x 220 mm face plates

0577 10	Surface mounting box - upto 2 sockets	962	2
0589 38	Surface mounting box with 5 module dinrail - upto 2 sockets	2712	1
0577 05	Surface mounting box with 12 module dinrail - upto 4 sockets	5930	1
0577 06	Surface mounting box with 18 module dinrail - upto 6 sockets	8302	1

Face plates 125 x 220 mm without sockets

0577 12	For 1 x 16 A or 32 A - upto A socket	922	5
0577 13	For 2 x 16 A - upto sockets	1214	5
0577 17	For 1 x 63 A - upto sockets	1112	5
0577 15	Blanking Plate	820	5

Bases for 125 x 280 mm faceplates

0577 11	Surface mounting box - upto 3 sockets	1002	3
0577 20	Surface mounting box with 5 module dinrail - upto 3 sockets	3052	1
0577 03	Surface mounting box with 12 module dinrail - upto 6 sockets	6150	1
0577 04	Surface mounting box with 18 module dinrail - upto 9 sockets	8554	1

Face plates 125 x 280 mm without sockets

0577 18	For 2 x 16 A and / or 32 A sockets	1442	4
0577 19	For 1 x 16 A or 32 A socket and 1 x 63 A socket	1424	2
0577 14	For 3 x 16 A sockets	1648	4
0577 16	Blanking plate	962	4

* MRP - Maximum Retail Price Inclusive of all taxes.

** LP - List Price Inclusive of excise duty but exclusive of sales tax or any other taxes.

Bold Cat.Nos are products normally available with Legrand (India) Stockists. Cat.Nos that are not bold - delivery within 4 - 8 weeks from the date of order. Bold packing quantity is our mandatory packing. Orders to be placed by Legrand (India) Stockist in multiples of the same.

Hypra industrial plugs and sockets

Cat.Nos	Polarity	LP* ₹ / Unit	Pack
---------	----------	-----------------	------

Sockets

Prisinter panel mounting sockets - IP 44, IK 09

0520 02	230 V, 16 A, 2P+E	12158	1/10
0527 02	230 V, 32 A, 2P+E	13004	1/6
0529 03	415 V, 32 A, 3P+E	13330	1/6
0529 04	415 V, 32 A, 3P+N+E	15840	1/6
0536 04	415 V, 63 A, 3P+N+E	40606	1

Panel mounting sockets - inclined IP 44, IK 09

0522 23	415 V, 16 A, 3P+E	1940	5/50
0538 23	415 V, 63 A, 3P+E	6056	1

Mobile sockets - IP 44, IK 09

0522 83	415 V, 16 A, 3P+E	4354	5/50
---------	-------------------	------	------

Plugs

Straight plugs - IP 44, IK 09

0520 42	250 V, 16 A, 2P+E	1988	5/50
0527 42	250 V, 32 A, 2P+E	2612	1/5
0522 43	415 V, 16 A, 3P+E	3448	5/50
0529 43	415 V, 32 A, 3P+E	3276	5/50
0529 44	415 V, 32 A, 3P+N+E	3632	5/15
0538 43	415 V, 63 A, 3P+E	8664	1/5
0538 44	415 V, 63 A, 3P+N+E	11644	1/5

Metra plugs and sockets

Plugs

Ivory

6500 22	240 V, 10 A, 2P+E	168	1/5/100
6500 28	240 V, 20 A, 2P+E	178	1/5/100

Grey

6500 02	240 V, 10 A, 2P+E	168	1/5/100
6500 08	240 V, 20 A, 2P+E	178	1/5/100
6500 10	440 V, 20 A, 3P+E	240	1/5/100
6500 16	440 V, 32 A, 3P+E	446	1/5/100

Sockets

6500 03	240 V, 10 A, 2P+E With blue cap	172	1/5/100
6500 23	240 V, 10 A, 2P+E With ivory cap	172	1/5/100
6500 09	240 V, 20 A, 2P+E With blue cap	196	1/5/100
6500 29	240 V, 20 A, 2P+E With ivory cap	196	1/5/100
6500 11	440 V, 20 A, 3P+E With red cap	162	1/5/100
6500 17	440 V, 32 A, 3P+E With red cap	446	1/5/100

*LP - List Price Inclusive of excise duty but exclusive of sales tax or any other taxes.

Plugs and sockets

Cat.Nos	Description	LP* ₹ / Unit	Pack
---------	-------------	-----------------	------

P17 tempra combined units

With interlocked switched sockets and surface mounting box IP 44

0566 01	250 V, 16 A, 2P+E	6536	1
0566 09	250 V, 32 A, 2P+E	7802	1
0566 13	415 V, 32 A, 3P+E	9436	1
0566 14	415 V, 32 A, 3P+N+E	9344	1

With interlocked switched sockets and surface mounting box IP 55

0566 21	250 V, 16A, 2P+E	7262	1
0566 29	250 V, 32 A, 2P+E	8298	1
0566 33	415 V, 32 A, 3P+E	10522	1
0566 34	415 V, 32 A, 3P+N+E	10104	1

With interlocked switched sockets and surface mounting box IP 44 with DIN rail for 5 module DX³ protection

0566 41	250 V, 16A, 2P+E	6580	1
0566 49	250 V, 32 A, 2P+E	8006	1
0566 53	415 V, 32 A, 3P+E	9384	1
0566 54	415 V, 32 A, 3P+N+E	9298	1

With interlocked switched sockets and surface mounting box IP 66 with DIN rail for 5 module DX³ protection

0566 61	250 V, 16 A, 2P+E	7374	1
0566 69	250 V, 32 A, 2P+E	8556	1
0566 73	415 V, 32 A, 3P+E	9790	1
0566 74	415 V, 32 A, 3P+N+E	9982	1

With interlocked switched sockets and without surface mounting box IP 55

0572 21	250 V, 16 A, 2P+E	6288	1
0572 29	250 V, 32 A, 2P+E	7110	1
0572 33	415 V, 32 A, 3P+E	8442	1
0572 34	415 V, 32 A, 3P+N+E	9220	1
0572 95	415 V, 63 A, 3P+N+E, IP 66	25906	1
0577 00	Base box for 0572 95	3824	1

P17 tempra combined units

with interlocked switched sockets IP 66

0572 98	380 to 415 V, 50/60 Hz, 63 A, 3P + E	21300	1
0589 10	380 to 415 V, 50/60 Hz, 63 A, 3P + N + E	24344	1
0589 18	380 to 415 V, 50/60 Hz, 63 A, 3P + E with provision for 5 module DX ³ protection	28028	1
0572 99	380 to 415 V, 50/60 Hz, 63 A, 3P+N+E with provision for 5 module DX ³ protection	29332	1



0566 09

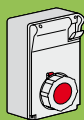

0566 34



0566 41



0566 74



0572 34



0572 98
0589 10

0589 18
0572 99

Bold Cat.Nos are products normally available with Legrand (India) Stockists. Cat.Nos that are not bold - delivery within 4 - 8 weeks from the date of order. Bold packing quantity is our mandatory packing. Orders to be placed by Legrand (India) Stockist in multiples of the same.

Legrand

a global edifice

Legrand is global specialist in electrical and digital building infrastructures. The Group's headquarter is based at Limoges, France. Legrand (India), the pioneer of Miniature Circuit Breakers in India, is the Indian subsidiary of Legrand Group. The Group services the needs of residential, commercial, hospitality and industrial sectors.

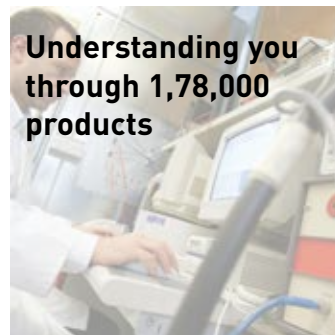
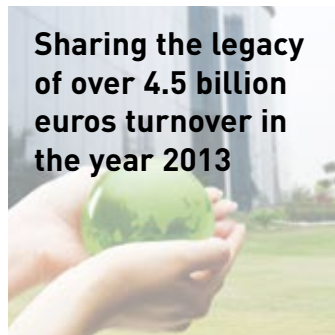
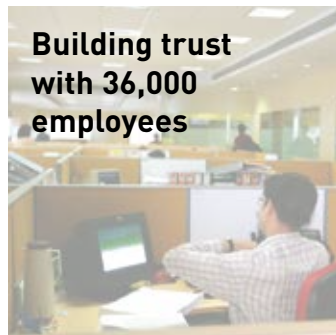

- Manufacturing facilities in 70 countries and sale of products in 180 countries.
- The only company manufacturing low voltage electrical equipments complying to all the important world standards
- World leader in wiring devices and cable management.
- The group designs and manufactures over 98 product families comprising of 1,78,000 products annually, with due emphasis on high performance, simplified installation and user convenience.
- Close to 1/3 of Legrand's capital expenditure is dedicated to the development of new products.
- Every year, Legrand invests around 5% of its global turnover on research and development activities involving over 2100 people worldwide.

Legrand Group Values

Customer Awareness

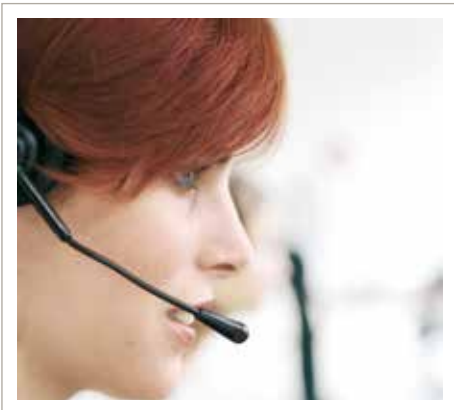

Innovation



Resource Enhancement



Ethical Behaviour



Legrand prestigious projects

- > Some of the prestigious projects we have been proud to associate with.
- > The group services the needs of residential, commercial, hospitality and industrial projects.

NORTH



Orient Taj - Agra



Ranbaxy - Gurgaon



DLF's Magnolias - Gurgaon

EAST



City Centre 2 - Kolkata



Mani Square - Kolkata



Uniworld City - Kolkata

WEST



Park Plaza - Mumbai



Wankhede Stadium - Mumbai



Kalpataru Aura - Mumbai

SOUTH



Accenture - Chennai



Nokia - Siemens Network - Chennai



Plaza Reality - Green Acres - Chennai

CENTRAL



Green City - Vizag



Vishnunivasa - Trimula



Apollo DB City - Indore

P17 Tempra Combined Units

closed... it's connected!

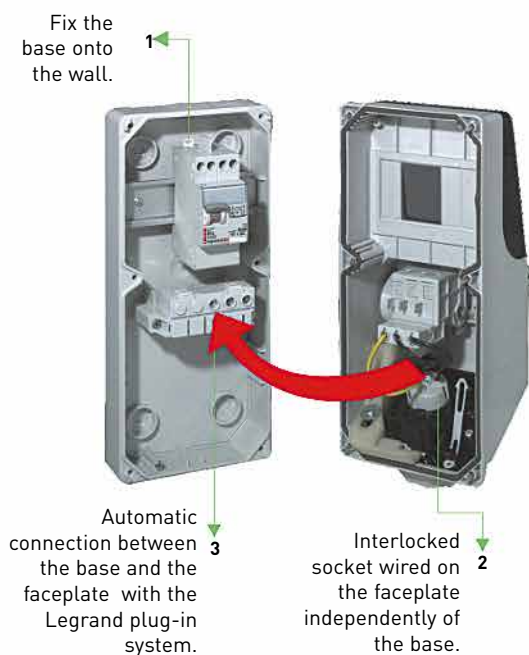

- **Transparent window**
For quick viewing of protection devices.



- **Din rail**
For full access to all Legrand Lexic modular functions upto 5 module.



- **Double interlock**
Switch cannot be turned on unless a plug has been inserted (1st safety position). Plug cannot be removed when the switch is on (2nd safety position).

Refer p. 148

NOTES :

- All Prices listed in this price list except DMX³ ACBs (p.7 – 10), DRX & DPX³ MCCBs (p.12 – 25), Alpican Capacitors (P. 35), DX³ SPDs & changeover switches (p.45 – 47), Lexic Ammeters (p.47), Ekinox³ and Ekinoxe DBs (p.52–59), Cable management solutions (p.108–129), P17 tempra pro plugs and sockets (p.147–148) are given as Maximum retail price (MRP) which is inclusive of all taxes.
- The prices of DMX³ ACBs (p.7 – 10), DRX & DPX³ MCCBs (p.12 – 25), Alpican Capacitors (P.35), DX³ SPDs & changeover switches (p.45 – 47), Lexic Ammeters (p.47), Ekinox³ and Ekinoxe DBs (p.52–59), Cable management solutions (p.108–129) , P17 tempra pro plugs and sockets (p.147-148) are given as List Price (LP) which is inclusive of Excise Duty but exclusive of sales tax or any other taxes. Sales tax and local levies such as octroi, as applicable, will be charged at actual.
- The prices of DMX³ ACBs (p.7 – 10), LCS2 Structured Cabling System (p.132–143) are available on request. The prices of Arteor selected products (p.76–87) are also available on request.
- All prices are ex our works packed in paper cartons.
- Prices subject to change without notice Prices charged will be as ruling at time of delivery. Any increase in statutory duty like excise will be to customer's account.
- All distribution boards, plug & socket enclosures, metal / plastic one-way enclosures are supplied without devices.
- Arteor™, Myrius™, & Mylinc™ cover plates, DLP trunking, floor boxes, pop-up boxes, Power & data desk grommets, Desktop multi-extension outlets and VDI distribution blocks are supplied without mechanisms.

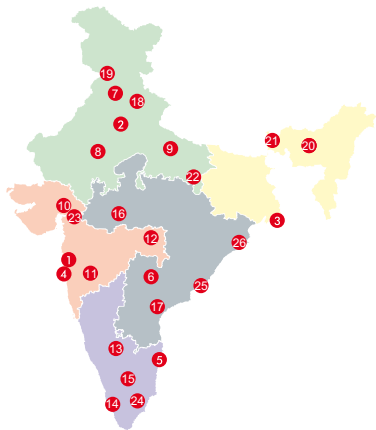

Head office

- 61 & 62, 6th Floor,
Kalpataru Square, Kondivita Road,
Off Andheri-Kurla Road, Andheri (E),
MUMBAI – 400 059.
Tel : (022) 3041 6200
Fax : (022) 3041 6201
Website : www.legrand.co.in

Regional sales offices

- A-25, Mohan Co-operative
Industrial Estate, Mathura Road,
NEW DELHI - 110 044.
Tel : (011) 3990 2200, 2699 0046,
(011) 2699 0028 / 29 / 30 / 31
Fax : (011) 2699 0047
- Bhakta Towers, 2nd & 3rd Floor,
Plot No. KB 22, Sector-III, Saltlake,
KOLKATA – 700 098.
Tel : (033) 4021 3535 / 36
Fax : (033) 4021 3537
- C/203, Corporate Avenue, Atul Projects,
Near Mirador Hotel, Chakala,
Andheri Ghatkopar Link Road,
Andheri – East, **MUMBAI** – 400 099.
Tel : (022) 3385 6200
- 10 B, (10th Floor), Prestige Center Court
Office Block Vijaya Forum Mall, #183,
N.S.K. Salai, Vadapalani
CHENNAI – 600 026.
Tel : (044) 3024 7200 / 2362 3125 / 35 / 45
Fax : (044) 2362 3165
- 205-208, 2nd Floor,
Block - II, White House,
Kundan Bagh, Begumpet,
HYDERABAD – 500 016.
Tel : (040) 2341 4398 / 67, 4567 1717
Fax : (040) 4567 1730

Branch offices

- SCO 1-2-3,
Second Floor, Sector 17B,
CHANDIGARH – 160 017.
Tel : (0172) 305 8631 / 32 / 33 / 34 / 35
Fax : (0172) 501 9008
- 507-510, Vth Floor, Soni Paris Point,
Jai Singh Highway, Banipark,
JAIPUR – 302 016.
Telefax : (0141) 511 3129, 510 1179
- 209-A, 2nd Floor, Cyber Heights,
Opp. Indira Gandhi Pratishthan,
Vibhuti Khand, Gomti Nagar
LUCKNOW - 226 010.
Tel : (522) 319 2031 / 32 / 33
- 504, Sakar IV,
Opp : M.J. Library, Ellis Bridge,
AHMEDABAD – 380 006.
Tel : (079) 2658 6561
- 402, Swastik Chambers,
Near Ashwamegh Marriage Hall,
Behind HP Petrol Pump,
Off Karve Road, Erandwane,
PUNE – 411 004.
Tel : (020) 6729 5601 / 602
Fax : (020) 6729 5604
- Plot No.95, II Floor, Shreyash Heights,
VIP Road, Ramdaspath,
NAGPUR – 440 010.
Tel : (0712) 662 7857 / 858
Fax : (0712) 662 7859
- 2nd Floor, Al' Latheef Building,
2/1, Union Street, Off. Infantry Road,
BANGALORE – 560 001.
Tel : (080) 2286 1078, 4113 3293
Fax : (080) 4113 3294
- J. B. Manjooran Estate,
Door No 50/1107A9, 3rd Floor,
Bye Pass Junction, Edappally,
COCHIN – 682 024.
Tel : (0484) 280 1921 / 2921, 658 0921
Fax : (0484) 280 1921 / 2921
- B-5, 1st Floor, Thirumalai Towers,
723, Avanashi Road,
COIMBATORE – 641 018.
Tel : (0422) 650 2728, 222 3634 / 0283
Fax : (0422) 222 3164
- 204-205, Megapolis Square,
579, M G Road,
INDORE – 452 001.
Tel : (0731) 393 1650 / 51 / 52
Fax : (0731) 393 1653
- MF-2, Datta's Lords House,
Jammi Chettu Street, Mogalrajapuram,
VIJAYAWADA – 520 010.
Tel : (0866) 661 1393, 664 6393
Fax : (0866) 669 9393

Area offices

- ABC Business Club 16,
Tagore Villa,
DEHRADUN – 248 001.
Tel : (0135) 271 5189
Fax : (0135) 271 5580
- Cabin No. 9,
Second Floor,
Madhok Trade Centre,
Madhok Complex,
Ferozpur Road,
LUDHIANA – 141 001.
Tel : (0161) 277 0301 / 2 / 3 / 4
- House No. 97,
Ground Floor,
Rajgarh Main Road,
Opp. City Heart Nursing Home,
GUWAHATI – 781 007.
Tel : (0361) 245 8498
- 94, Udham Singh Sarani,
Ground Floor, Ashrampara,
SILIGURI – 734 001.
Tel : (0353) 264 1067
- 202 & 203, 2nd Floor,
Sunrise, Forum 100,
Burdwan Compound, Lalpur,
RANCHI - 834 001.
Tel : +91 9088104858
- 405, City Centre, Sosyo Circle,
Udhana Magdalla Road,
SURAT - 395 002.
Tel : (0261) 263 3861
- Aparna Towers, 1st Floor,
2/3, Bypass Road,
MADURAI – 625 010.
Telefax : (0452) 230 8414
- 404, Eshwar Plaza,
Dwaraka Nagar, Main Road,
Beside Bata Show Room,
VISHAKHAPATNAM – 530 016.
Tel : (0891) 663 5652
Fax : (0891) 663 9363
- Plot No. 359,
Saheed Nagar, 2nd Floor,
BHUBANESWAR – 751 007.
Tel : (0674) 254 0623

Technical assistance from Legrand

Telephonic technical assistance for selection of products, technical information, guidance, wiring diagrams and estimation is now made available to you at each Regional Office. Contact the Technical Officer of Legrand at the following telephone numbers

- New Delhi** : Tel.: (011) 2699 0028, 3990 2200
Kolkata : Tel.: (033) 4021 3535 / 36
Mumbai : Tel.: (022) 3385 6200
Chennai : Tel.: (044) 3024 7200
Hyderabad : Tel.: (040) 2341 4398 / 67, 4567 1717

For other places, contact the nearest
Regional / Branch / Area offices

customer.care@legrand.co.in

